



TIMBERLAKE

PLAYHOUSE

MODEL #: 65314

D I S C O V E R Y



WARNING

Adult Assembly Required.
*Not suitable for children under two years,
due to sharp points and small parts.*



- *Owner's Manual*
- *Frequently Asked Questions*
- *Assembly Instructions*
- *Warranty Information*

*Manufacturer: Backyard Discovery
3001 North Rouse
Pittsburg, KS 66762
1-800-856-4445*

*Register your new play house on-line @ www.swingsetonline.com
(you will also find any updates on assembly instructions and
information to order replacement parts)*

*Features the **SAFE-T-FUSE** fastening system.*



*Save this assembly manual for future reference in the event that
you need to order replacement parts.*

STOP PARE

Missing A Part?

**CALL US BEFORE GOING
BACK TO THE STORE!**

The store where you made your purchase
does not stock parts for this item.

If you have assembly questions or if you need parts,
whether they are missing or damaged

Call Toll-Free Help Line or visit www.swingsetsonline.com

¡LLÁMENOS ANTES DE REGRESAR A LA TIENDA!

La tienda donde realizó la compra no almacena piezas de este producto.

Si tiene preguntas sobre el ensamblaje o si necesita piezas debido a que
faltan o están dañadas

llame gratis a la línea de ayuda

1-800-856-4445

PLEASE READ THIS BEFORE STARTING ASSEMBLY POR FAVOR LEA ESTAS INSTRUCCIONES ANTES DE COMENZAR EL ENSAMBLAJE

- READ THE ASSEMBLY MANUAL COMPLETELY, PAYING SPECIAL ATTENTION TO THE IMPORTANT TIPS AND SAFETY INFORMATION.
- AFTER YOU HAVE READ THE ASSEMBLY MANUAL, YOU WILL BE ABLE TO DECIDE IF YOU NEED PROFESSIONAL HELP TO COMPLETE THE ASSEMBLY OF THE STRUCTURE.
- SEPARATE AND IDENTIFY ALL PARTS TO MAKE SURE THAT YOU HAVE ALL OF THE PARTS LISTED.
- IF YOU CAN'T FIND ALL OF THE PARTS, CHECK THE PACKING MATERIAL. SMALL PARTS MAY HAVE FALLEN INTO IT DURING SHIPMENT.
- IF YOU HAVE PROBLEMS WITH THE ASSEMBLY OR IF ANY PART IS MISSING OR DAMAGED, PLEASE CALL THE HELP LINE **1-800-856-4445 OR VISIT www.swingsetsonline.com**
- LEA EL MANUAL DE ENSAMBLAJE COMPLETAMENTE, PRESTANDO ESPECIAL ATENCIÓN A LOS CONSEJOS ÚTILES IMPORTANTES Y A LA INFORMACIÓN SOBRE SEGURIDAD.
- DESPUÉS DE QUE HAYA LEÍDO EL MANUAL DE ENSAMBLAJE, PODRÁ DECIDIR SI NECESITA AYUDA PROFESIONAL PARA EFECTUAR EL ENSAMBLAJE DE LA ESTRUCTURA.
- SEPARE E IDENTIFIQUE TODAS LAS PIEZAS PARA COMPROBAR QUE DISPONE DE TODAS LAS PARTES INDICADAS.
- SI NO PUEDE ENCONTRAR TODAS LAS PIEZAS, REVISE EL MATERIAL DE EMPAQUE. ES POSIBLE QUE ALGUNAS PIEZAS PEQUEÑAS PUEDAN HABERSE CAÍDO ALLÍ DURANTE EL ENVÍO.
- MANTÉNGASE ALEJADO DE LOS NIÑOS MENORES A LA EDAD RECOMENDADA.
- SI TIENE PROBLEMAS CON EL ENSAMBLAJE O SI ALGUNA PIEZA FALTA O ESTÁ DAÑADA, LLAME A LA LÍNEA DE AYUDA AL **1-800-856-4445 O VISITE www.swingsetsonline.com**

PLEASE HAVE THE FOLLOWING INFORMATION WHEN YOU MAKE YOUR CALL:

- 1 – MODEL NUMBER OF THE PRODUCT LOCATED ON THE FRONT OF THE ASSEMBLY MANUAL
- 2 – DESCRIPTION OF THE PART FROM THE PARTS LIST

POR FAVOR TENGA VISIBLE LA SIGUIENTE INFORMACIÓN CUANDO LLAME:

- 1 - NÚMERO DE MODELO DEL PRODUCTO QUE SE ENCUENTRA UBICADO AL FRENTE DEL MANUAL DE ENSAMBLAJE
- 2 - DESCRIPCIÓN DE LA PIEZA QUE SE ENCUENTRA EN LA LISTA DE PIEZAS

Owner's Manual Play House

Dear Customer:

Please read entire booklet completely before beginning the assembly process.

Equipment is recommended for use by **children 2 to 10 years of age**. Structures are **not intended for public use**. **The Company does not warranty any of its residential structures subjected to commercial use such as: Daycare, Preschool, Nursery School, Recreational Park, or any similar Commercial Application.**



WARNING: This Symbol points out important safety instructions which, if not followed, could endanger the personal safety of yourself and your children and/or damage your property. You **MUST** read and follow all instructions in this manual before attempting to use this play house.



WARNING: Children must **NOT** use this play house until unit has been completely assembled and inspected by an adult to insure set has been properly assembled. Please follow all recommendations below. **Failure to do so may result in the warranty being void and/or safety violations that could result in serious injury.** This manual contains helpful information concerning Assembly Preparation, Installation Procedure, and Required Maintenance. Always keep the safety of your children in mind as your play structure is being built and as your children play with the unit. Before your children play with the unit please review the Operation Instructions with them to help ensure their safety.

PLEASE RETAIN THESE INSTRUCTIONS FOR FUTURE REFERENCE. KEEP THEM IN A SAFE PLACE WHERE YOU CAN REFER TO THEM AS NEEDED. IN ORDER TO PROVIDE YOU WITH THE MOST EFFICIENT SERVICE, IT IS REQUIRED THAT YOU PROVIDE US WITH THE PART NUMBERS WHEN ORDERING PARTS.

For Your Records:

Please take time and fill out the information below. This information will be needed for warranty issues.

Where Purchased: _____

Date of Purchase: _____

Installation Date: _____

Installed by: _____

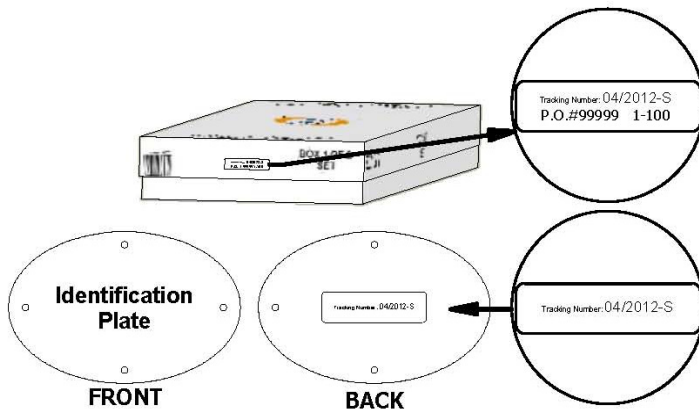

Tracking Number Reference Label

Tracking ID number on the carton and back of the ID plate are included for tracking purposes associated with warranty claims.

Owner's Manual Play House

Please refer to the Assembly section of the Assembly Manual for Maximum Fall Height.

Positioning Your Play house

1. *The Play house is designed to be installed on a level surface **by an Adult with an Adult helper**. Place in a flat area of your yard to minimize ground preparation.*
2. *Choose a level location for the equipment. This can reduce the likelihood of the play house tipping over and loose-fill surfacing material washing away during heavy rains.*
3. *Place the equipment not less than **6 ft (1.8 m)** from any structure or obstruction such as a fence, garage, house, overhanging branches, laundry lines, or electrical wires.*
4. *It is a good idea to place your Play house in an area that is convenient for adults to watch children at play.*
5. *Create a site free of obstacles that could cause injuries – such as low overhanging tree branches, overhead wires, tree stumps and/or roots, large rocks, bricks and concrete. We have additional suggestions in the Suggested Playground Surfacing Section.*
6. *Do not build your play house on top of surfacing material.*

Suggested Playground Surfacing

- ❑ *Playground equipment should never be placed on hard surfaces such as concrete or asphalt.*
- ❑ *Do not install loose fill surfacing over hard surfaces such as concrete or asphalt.*
- ❑ *Shredded bark mulch, wood chips, fine sand and fine gravel, are added as shock absorbing materials after assembly. If used properly these materials can absorb some of the impact of a child's fall.*
- ❑ *All surface material should extend a minimum of 6 feet or (1.8 m) in all directions around the play area.*
- ❑ *Do not apply playground surfacing until after the unit is completely constructed. Play house should **not** be built on top of surfacing.*
- ❑ *Use containment, such as digging out around the perimeter and/or lining the perimeter with landscape edging.*
- ❑ *Installations of rubber tiles or poured-in-place surfaces (other than loose-fill materials) generally require a professional and are not “do-it-yourself” projects.*
- ❑ *Shall use Playground Surfacing Materials (other than loose-fill material) which comply with the safety standard **ASTM F1292** Standard Specification of Impact Attenuation of Surfacing Materials within the Use Zone of Playground Equipment.*

Owner's Manual Play House

The following chart explains the fall height in feet from which a life threatening head injury would not be expected

Critical Heights in feet (m) of Tested Materials

Material	Uncompressed Depth			Compressed Depth
	6" (152mm)	9" (228mm)	12" (304mm)	to 9" (228mm)
Wood Chips	7' (2.13m)	10' (3.05m)	11' (3.35m)	10' (3.05m)
Double-Shredded bark mulch	6' (1.83m)	10' (3.05m)	11' (3.35m)	7' (2.13m)
Engineered Wood Fibers	6' (1.83m)	7' (2.13m)	>12' (3.66m)	6' (1.83m)
Fine Sand	5' (1.52m)	5' (1.52m)	9' (2.74m)	5' (1.52m)
Coarse Sand	5' (1.52m)	5' (1.52m)	6' (1.83m)	4' (1.22m)
Fine Gravel	5' (1.52m)	7' (2.13m)	10' (3.05m)	6' (1.83m)
Medium Gravel	5' (1.52m)	5' (1.52m)	6' (1.83m)	5' (1.52m)
Shredded Tires*	10-12' (3.0-3.6m)	N/A	N/A	N/A

*This data is from tests conducted by independent testing laboratories on a 6-inch depth of uncompressed shredded tire samples produced by four manufacturers. The tests reported critical heights, which varied from 10 feet to greater than 12 feet. It is recommended that persons seeking to install shredded tires as a protective surface request test data from the supplier showing the critical height of the material when it was tested in accordance with ASTM F1292.

Operating Instructions:



NOTE: Your children's safety is our #1 concern. Observing the following statements and warnings reduces the likelihood of serious or fatal injury. Please review these safety rules regularly with your children.

1. On-site adult supervision is **required**.
2. Instruct children **not** to climb when the equipment is wet.
3. Instruct children to **never** crawl on top of a play house roof.
4. The parents should have the children **dress appropriately** with well-fitting shoes. Loose clothing such as scarves and ponchos should not be worn. Always take off, tie up or tuck in cords and drawstrings on children's clothing. These things can get caught on playground equipment and strangle a child.
5. Instruct children **not** to attach items to the equipment that are not specifically designed for use with that equipment (such as ropes, clothesline, pet leashes, etc.).
6. Instruct children to **remove** their bike or other sports helmet before playing on the playground equipment.

Maintenance Instructions:

At the beginning of each play season:

- Tighten all hardware.
- Lubricate all metallic moving parts per manufacture's instructions.
- Check all protective coverings on bolts, pipes, edges and corners. Replace if they are loose, cracked, or missing.

Owner's Manual Play House

- *all moving parts including swing seats, ropes, cables, and chains for wear, Check rust, or deterioration. Replace as needed.*
- *Check metal parts for rust. If found, sand and repaint using non Lead-based paint meeting the requirements of Title **16 CRF Part 1303**.*
- *Modifications not approved by the party responsible for compliance could void user's authority to operate the equipment.*
- *Check all wood members for deterioration and splinters. Sand down and splinters and replace deteriorating members.*
- *Reinstall any plastic parts, such as swing seats or any other items that were removed in the cold season.*
- *Rake and check depth of loose fill protective surfacing materials to prevent compaction and to maintain appropriate depth. Replace as necessary.*

Twice a month during play season:

- *Tighten all hardware.*
- *Lubricate all metallic moving parts per manufacture's instructions.*
- *Check all protective coverings on bolts, pipes, edges and corners. Replace if they are loose, cracked, or missing.*
- *Check all moving parts including swing seats, ropes, cables, and chains for wear, rust, or deterioration. Replace as needed.*
- *Rake and check depth of loose fill protective surfacing materials to prevent compaction and to maintain appropriate depth. Replace as necessary.*

At the end of each play season or when the temperature drops below 32° F:

- *Remove plastic swing seats and other items as specified by the manufacturer and take indoors or do not use.*
- *Rake and check depth of loose fill protective surfacing materials to prevent compaction and to maintain appropriate depth. Replace as necessary.*

Additional Maintenance:

- *Check the swing beam and hardware every two weeks due to wood expansion and contraction. It is particularly important that this procedure be followed at the beginning of each season.*
- *Inspect all wood members monthly. The grain of the wood sometimes will lift in the dry season causing splinters to appear. Light sand may be necessary to maintain a safe playing environment. Treat your play house with stain regularly, to help prevent severe checking/splitting and other weather damage.*
- *We have applied a waterborne transparent stain to your unit. This is done for color only. Once or twice a year, depending on your climate conditions, you must apply some type of protection (sealant) to the wood of your unit. Prior to the application of sealant, lightly sand any "rough" spots on your play house. **Please note this is a requirement of your warranty.***
- *Creating and maintaining the Play house on a level location is very important. Make sure the play house is level and true once each year or at the beginning of each play season.*
- *Rake the surface periodically to prevent compaction and maintain appropriate depths.*

Owners shall be responsible for maintaining the legibility of the warning labels.

Owner's Manual Play House

Disposal Instructions:

When the Play house use is no longer desired, it should be disassembled and disposed of in such a way that no unreasonable hazards will exist at the time the unit is discarded.

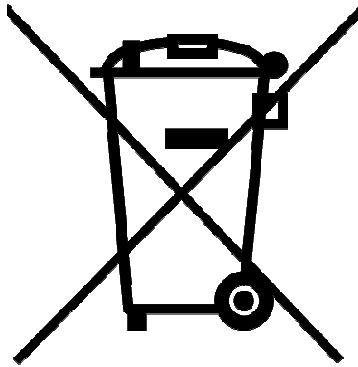

This package must be kept because it contains important information!

Owner's Manual Play House

APPENDIX A

Information on Playground Surfacing Materials:

The following information is from the **United States Consumer Product Safety Commission's Information Sheet for playground surfacing material**; also see the following website for additional information.:

www.cpsc.gov/cpscpub/pubs/323.html

X3. CONSUMER INFORMATION SHEET FOR PLAYGROUND SURFACING MATERIALS¹¹

X3.1 *Select Protective Surfacing*—One of the most important things you can do to reduce the likelihood of serious head injuries is to install shock-absorbing protective surfacing under and around your play equipment. The protective surfacing should be applied to a depth that is suitable for the equipment height in accordance with ASTM Specification **F 1292**. There are different types of surfacing to choose from; whichever product you select, follow these guidelines:

X3.1.1 *Loose-Fill Materials:*

X3.1.1.1 Maintain a minimum depth of 9 inches of loose-fill materials such as wood mulch/chips, engineered wood fiber (EWF), or shredded/recycled rubber mulch for equipment up to 8 feet high; and 9 inches of sand or pea gravel for equipment up to 5 feet high. NOTE: An initial fill level of 12 inches will compress to about a 9-inch depth of surfacing overtime. The surfacing will also compact, displace, and settle, and should be periodically refilled to maintain at least a 9-inch depth.

X3.1.2 Use a minimum of 6 inches of protective surfacing for play equipment less than 4 feet in height. If maintained properly, this should be adequate. (At depths less than 6 inches, the protective material is too easily displaced or compacted.) NOTE: Do not install home playground equipment over concrete, asphalt, or any other hard surface. A fall onto a hard surface can result in serious injury to the equipment user. Grass and dirt are not considered protective surfacing because wear and environmental factors can reduce their shock absorbing effectiveness. Carpeting and thin mats are generally not adequate protective surfacing. Ground level equipment such as a sandbox, activity wall, playhouse or other equipment that has no elevated play surface – does not need any protective surfacing.

X3.1.3 Use containment, such as digging out around the perimeter and/or lining the perimeter with landscape edging. Don't forget to account for water drainage.

X3.1.3.1 Check and maintain the depth of the loose-fill surfacing material. To maintain the right amount of loose-fill materials, mark the correct level on play equipment support posts. That way you can easily see when to replenish and/or redistribute the surfacing.

X3.1.3.2 **Do not** install loose-fill surfacing over hard surfaces such as concrete or asphalt.

X3.1.4 *Poured-In-Place Surfaces or Pre-Manufactured Rubber Tiles* — You may be interested in using surfacing other than loose-fill materials – like rubber tiles or poured-in-place surfaces.

X3.1.4.1 Installations of these surfaces generally require a professional and are not “do-it-yourself” projects.

X3.1.4.2 Review surface specification before purchasing this type of surfacing. Ask the installer/manufacturer for a report showing that the product has been tested to the following safety standard: ASTM **F 1292** Standard Specification for Impact Attenuation of Surfacing Materials within the Use Zone of Playground Equipment. This report should show the specific height for which the surface is intended to protect against serious head injury. This height should be equal to or greater than the fall height – vertical distance between a designated play surface (elevated surface for standing, sitting, or climbing) and the protective surfacing below – of your play equipment.

X3.1.4.3 Check the protective surfacing frequently for wear.

X3.1.5 *Placement* — Proper placement and maintenance of protective surfacing is essential. Be sure to:

X3.1.5.1 Extend surfacing at least 6 feet from the equipment in all directions.

Owner's Manual Play House

¹¹This information has been extracted from the CPSC publications "Playground Surfacing — Technical Information Guide" and "Handbook for Public Playground Safety." Copies of these reports can be obtained by sending a postcard to: Office of Public Affairs, U.S. Consumer Product Safety Commission, Washington, D.C., 20207 or call the toll-free hotline: 1-800-638-2772.

The American Society for Testing and Materials takes no position respecting the validity of any patent right asserted in connection with any item mentioned in this standard. Users of this standard are expressly advised that determination of the validity of any such patent rights, and the risk of infringement of such rights, are entirely their own responsibility.

The standard is subject to revision at any time by the responsible technical committee and must be reviewed every five years and if not revised, either approved or withdrawn. Your comments are invited either for revision of this standard or for additional standards and should be addressed to ASTM Headquarters. Your comments will receive careful consideration at a meeting of the responsible technical committee, which you may attend. If you feel that your comments have not received a fair hearing you should make your views known to the ASTM Committee on Standards. 100 Barr Harbor Drive, West Conshohocken, PA 19428.

Play House Assembly Manual FAQs:

- 1. Does the area for the play house need to be level? Yes. Backyard Discovery recommends the play house be positioned on a flat level area for maximum safety and durability. Any stakes provided should be used to secure it firmly to the ground.*
- 2. What size area is recommended for the play house? Backyard Discovery recommends at least a 6' (six foot) perimeter around and above the play house for maximum safety.*
- 3. What age range is appropriate for the play houses? Backyard Discovery play houses are recommended for children ages 2 – 10 years.*
- 4. Is the wood treated with chemicals? Backyard Discovery uses 100% Chinese Cedar wood which is naturally bug resistant, decay and rot resistant. To help ensure your child's safety, our wood is completely chemical free and we do not use pressure-treated wood. The stain we use is a top coat using a water-based product that is for appearance only.*
- 5. How often should the play house be stained? Backyard Discovery recommends the play house be stained once each year. A water or oil based stain can be used at the customer's discretion.*
- 6. Why does it seem that my play house is developing cracks? Wood is a natural material; no two pieces are exactly alike. Each piece has its own characteristics and personality and reacts differently to climate changes. When any wood product is exposed to the elements, it develops "wood checks". A check is the radial separation of the wood fibers running with the grain of the wood. These are caused by the varying temperature and moisture conditions. A check is not a crack – it does not affect the strength or durability of the wood or structural integrity of the play house.*
- 7. Do Backyard Discovery play houses come with a warranty? Yes. All Backyard Discovery products carry a 1-year replacement warranty on all parts for manufacturer's defect. Our wood carries a 5 year warranty on rot and decay as well. Please see warranty details for more information.*
- 8. What is the best way to get started assembling the play house? Backyard Discovery recommends taking all the parts out of the boxes and arranging them by part number before you begin any assembly. This will not only allow faster assembly, but will also identify any parts that may be missing or damaged so they can be replaced before assembly. If parts are missing or need replacement, go to www.swingsetsonline.com/support.aspx and follow the prompts to order them. Next, read the assembly manual and get the tools ready for the job as recommended in the manual. If the assembly manual is lost or misplaced a new one can be printed from Backyard Discovery's website: www.swingsetsonline.com.*
- 9. The play house seems to rock or sway too much. What's wrong? Rocking is caused by uneven ground or obstructions such as rocks, roots, etc. under the ground rails. These should be removed and the ground underneath re-leveled to prevent rocking. Also ensure the play house is securely staked to the ground using any stakes provided.*
- 10. The 2"x4" boards do not measure 2"x 4". Why not? In the U.S. it's common practice to describe lumber dimensions using the rough cut sizes from the sawmill and not the finished dimensions. Retailers, home stores, etc. all use this accepted practice for describing lumber dimensions. However, Backyard Discovery play houses are designed and constructed using the actual dimensions so everything fits properly and remains so during the life of the play house.*

For more information and frequently asked questions, please refer to our website at www.swingsetsonline.com.

Tools Required for Installation:

(These are the tools that are generally required for assembly of our outdoor products. These tools are not included with the outdoor product purchase.)

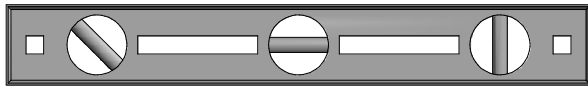

(Level 24")

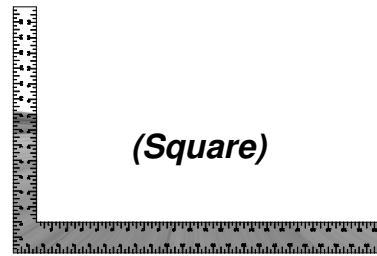

(Square)

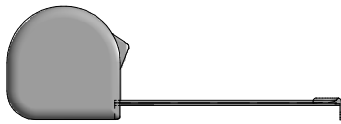

(Tape Measure)

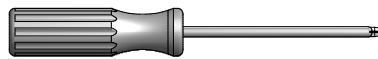

(Phillips Screw Driver)



(Claw Hammer)

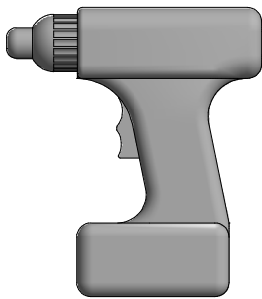

(Cordless Drill or Electric Drill)

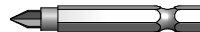

***(Drill Attachments:
Socket Driver)***

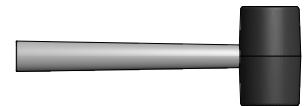

(Rubber Mallet - Optional)



(An Adult w/ an Adult Helper)



(Ladder)

SAFETY AND ASSEMBLY INFORMATION

SELECTING THE CORRECT LOCATION FOR YOUR PLAY PRODUCT IS IMPORTANT FOR YOUR CHILDREN'S SAFETY AND THE PRODUCT'S LONGEVITY

Dimensions:

- The Timberlake has one layout option.

Layout Ground Dimension
3'-6" x 3'-10 11/16" x 56" Tall

Safe Play Area*
15'-6" x 15'-10 3/4"

*Level Ground Surface - See below

General Information:

Your set has been designed and engineered for children only and for residential use only. A maximum of 150 lbs. per child is recommended for play activities designed for individual use. A maximum of 120 lbs. per child is recommended for play activities designed for multiple child use. A maximum of 6 children is recommended for this unit.

Safe Play Area:

- The safe play area refers to a zone extending 6' beyond the play product on all sides, including the space above the play product.
- The ground surface **must be level**. Installing your play product on sloping ground can cause it to lean or "rack". This leaning puts additional stress on all connections and joints and in time will cause those connections to loosen and fail.
- The safe play area must be free of all structures, landscaping, trees and branches, rocks, wires, and other obstacles to safe play. Children can be seriously injured running or swinging into these obstacles.
- Remove all tripping hazards from the safe play area. Tripping hazards include: roots, stumps, rocks, landscaping, sprinkler heads, railroad ties, plumbing and electrical connections.
- Play product needs to be installed on solid ground.

SAFE PLAY AREA DIAGRAM

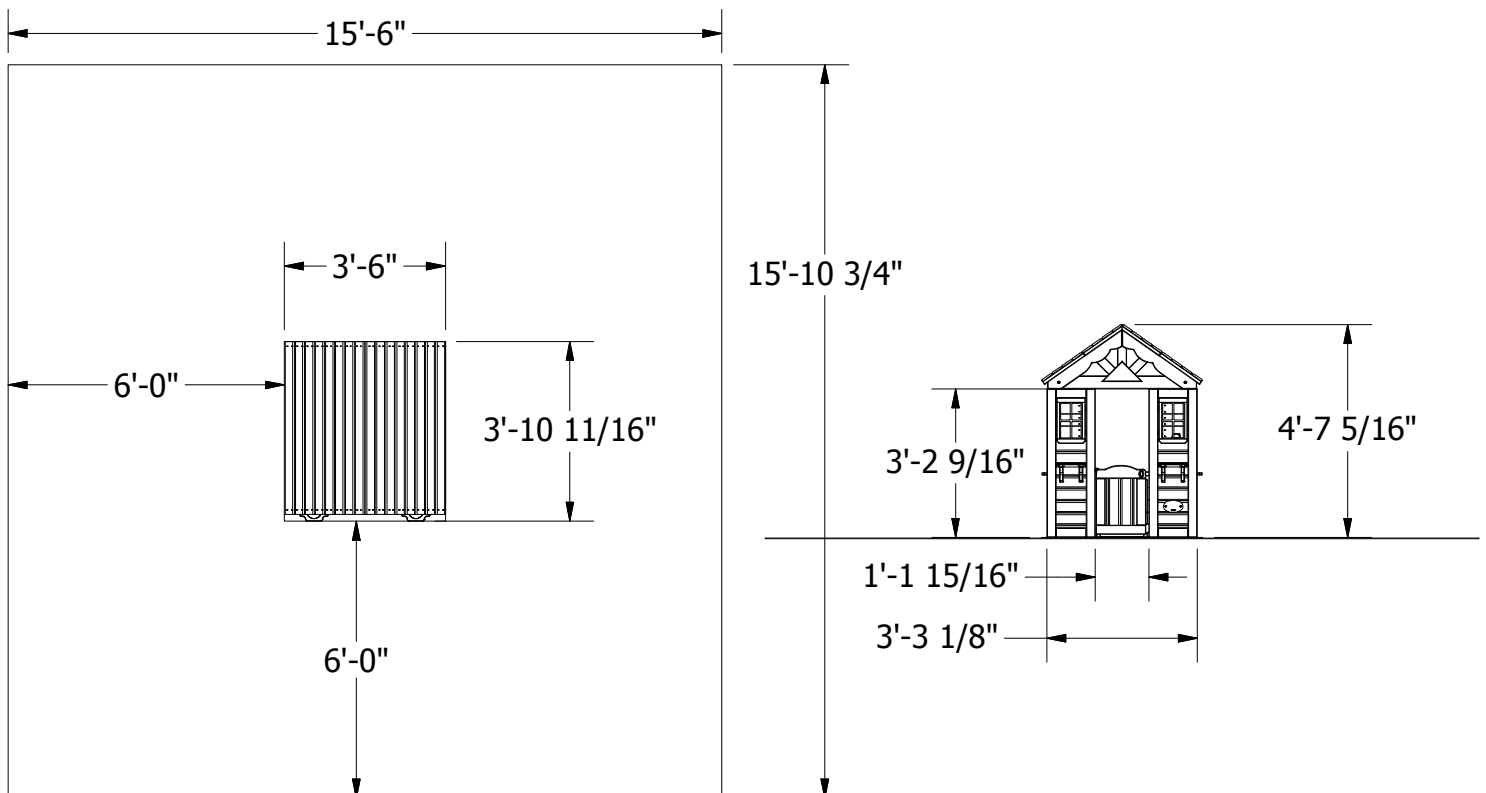

Parts Identification

Wood Components

(NOT TO SCALE)

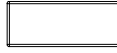

- (1) **J1 - COUNTER TOP SUPPORT - W4L04753**
1"x2 3/8"x5 7/8" (24x60x150)

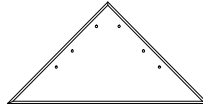

- (2) **K1 - TRIANGLE SUNBURST - W4L04871**
5/8"x5 1/4"x10 3/8" (16x134x265)

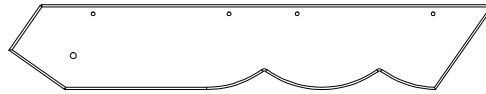

- (4) **L1 - GABLE BOARD - W4L04755**
5/8"x4 3/8"x25 3/8" (16x112x643)



- (2) **M1 - COUNTER TOP - W4L04754**
5/8"x3 3/8"x23 5/8" (16x86x600)

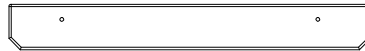

- (2) **N1 - SIDE WINDOW SHELF - W4L04751**
5/8"x2 3/8"x18 7/8" (16x60x479)



- (1) **N2 - REAR WINDOW SHELF - W4L04760**
5/8"x2 3/8"x19 1/8" (16x60x485)



- (1) **N3 - DOOR STOP - W4L04761**
5/8"x2 3/8"x3 7/8" (16x60x100)



- (8) **N4 - TIE STRAP - W102424**
5/8"x2"x3 1/8" (16x50x80)



- (2) **N5 - SUNBURST LEG - W4L04872**
5/8"x2 3/8"x10 1/4" (16x60x260)

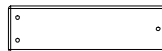

- (4) **N6 - SUNBURST LEG - W4L04873**
5/8"x2 3/8"x8 1/4" (16x60x210)

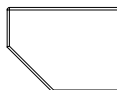

- (1) **Q1 - COUNTER TOP SUPPORT - W4L04752**
1"x4 3/8"x5 7/8" (24x112x150)

Parts Identification

Wood Components

(NOT TO SCALE)

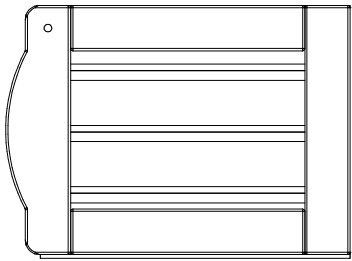

(1) DP1 - DOOR ASSEMBLY - W2A01511

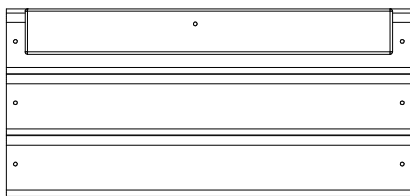

(1) WP7 - UPPER REAR CENTER WALL
- W2A01522

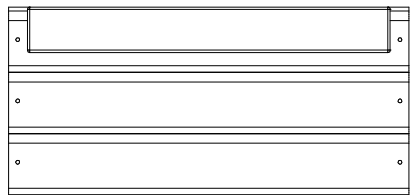

(2) WP6 - UPPER CENTER WALL
- W2A01510

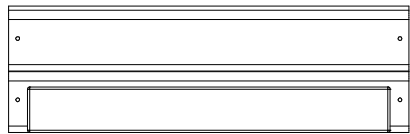

(2) WP5 - LOWER CENTER WALL
- W2A01509

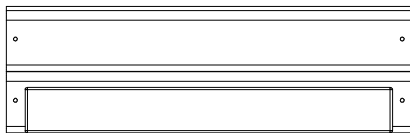

(1) WP8 - LOWER REAR CENTER WALL
- W2A01523

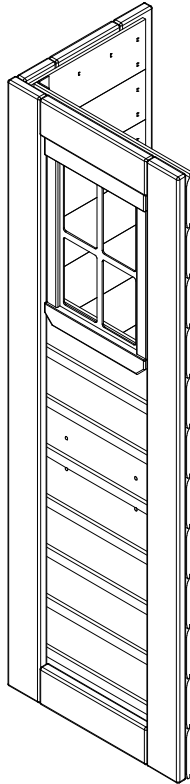

(1) WP1 - LEFT FRONT CORNER PANEL
- W2A01524

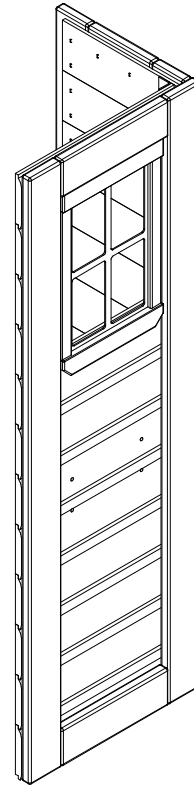

(1) WP2 - RIGHT FRONT CORNER PANEL
- W2A01525

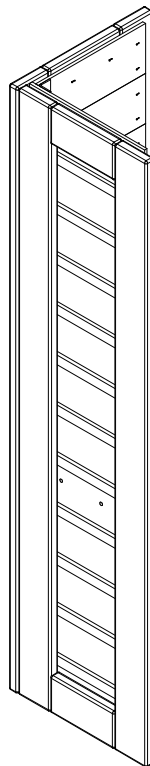

(1) WP3 - LEFT REAR CORNER PANEL
- W2A01526

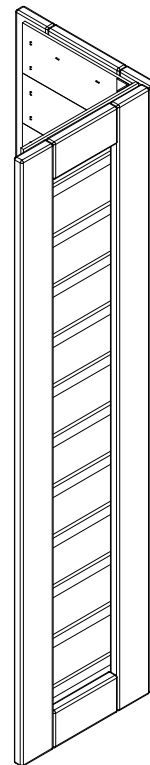

(1) WP4 - RIGHT REAR CORNER PANEL
- W2A01527

Parts Identification
Wood Components
(NOT TO SCALE)

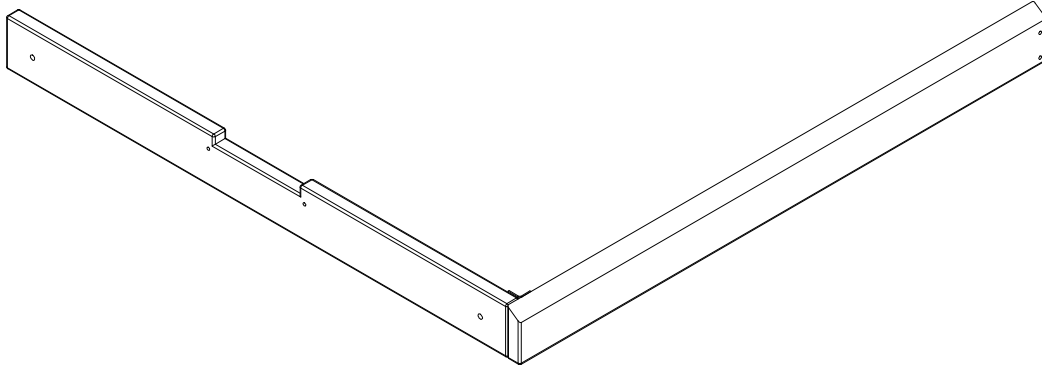

(2) WP9 - HEADER ASSEMBLY - W2A01539

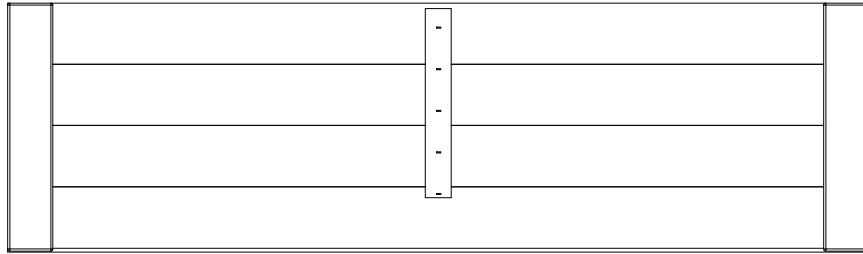

(2) RP1 - LOWER ROOF PANEL - W2A01513

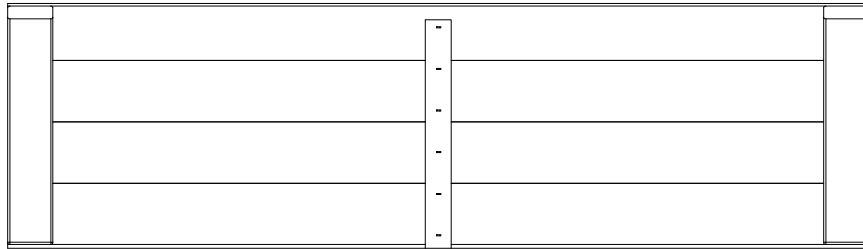

(2) RP2 - UPPER ROOF PANEL - W2A01514

Parts Identification

Hardware



(2) SCREW PFH 8x1/2 - H100124



(41) SCREW PFH 8x1 - H100085



(33) SCREW PFH 8x1 1/8 - H100088



(51) SCREW PFH 8x1 1/4 - H100087



(24) SCREW PFH 8x1 1/2 - H100086



(1) SCREW PFH 8x2 - H100111



(4) SCREW PFH 8x2 1/2 - H100090

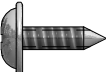

(2) SCREW PWH 8x7/16 - H100361



(4) SCREW PWH 8x5/8 - H100128



(9) SCREW PWH 8x3/4 - H100070

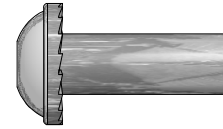

(4) NUT BARREL WH 1/4x7/8 - H100140

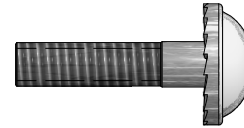

(4) BOLT WH 1/4x1 - H100137

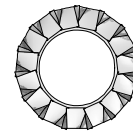

(4) WASHER LOCK EXT 8x15 - H100139

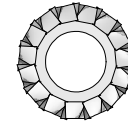

(4) WASHER LOCK EXT 6x15 - H100138

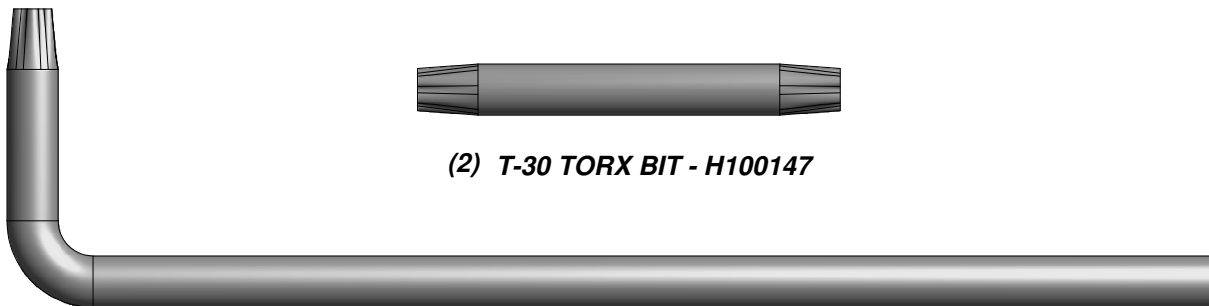

(2) T-30 TORX BIT - H100147

(2) T-30 TORX WRENCH - H100114

Parts Identification

Accessories

(NOT TO SCALE)



(1) PHONE KIT - A100132

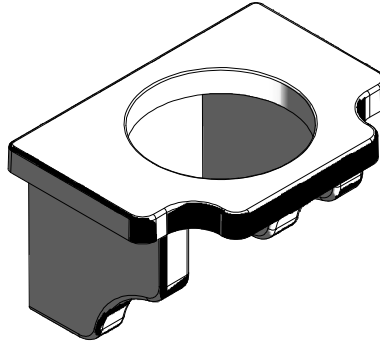

(2) FLOWER POT HOLDER - A6P00023

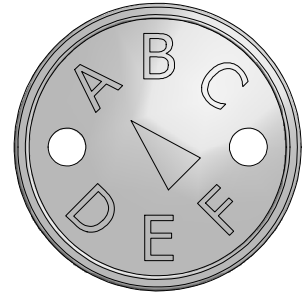

(1) "A" REVISION TAG - A100314

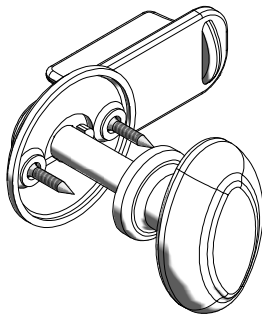

(1) KNOB KIT - A6P00020

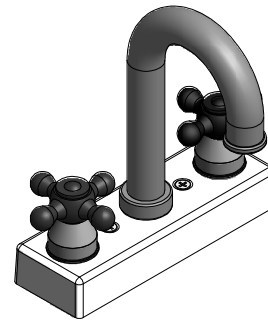

(1) FAUCET KIT - A6P00024

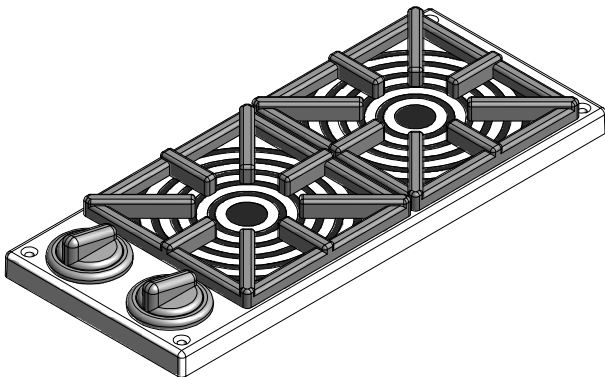

(1) STOVE KIT - A6P00025



(1) BYD ID TAG (MEDIUM) AGES 2 TO 10 - A4M00528

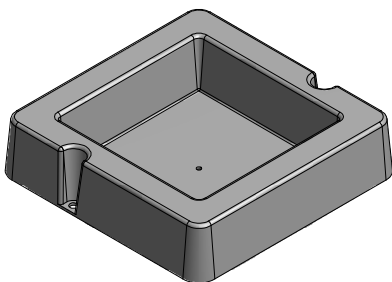

(1) SURFACE MOUNT BASIN - A6P00032

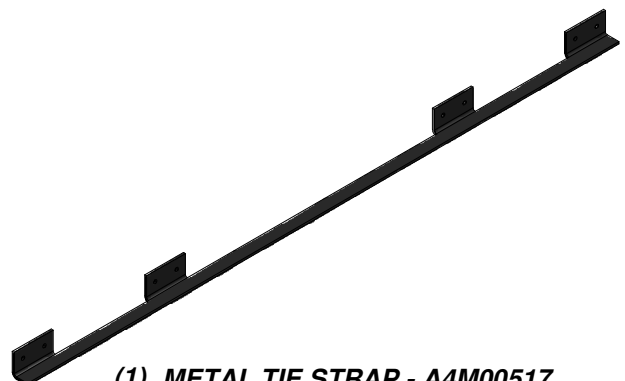

(1) METAL TIE STRAP - A4M00517

Playhouse Assembly

STEP 1:
STAND THE (4) CORNER WALL ASSEMBLIES AS SHOWN BELOW.

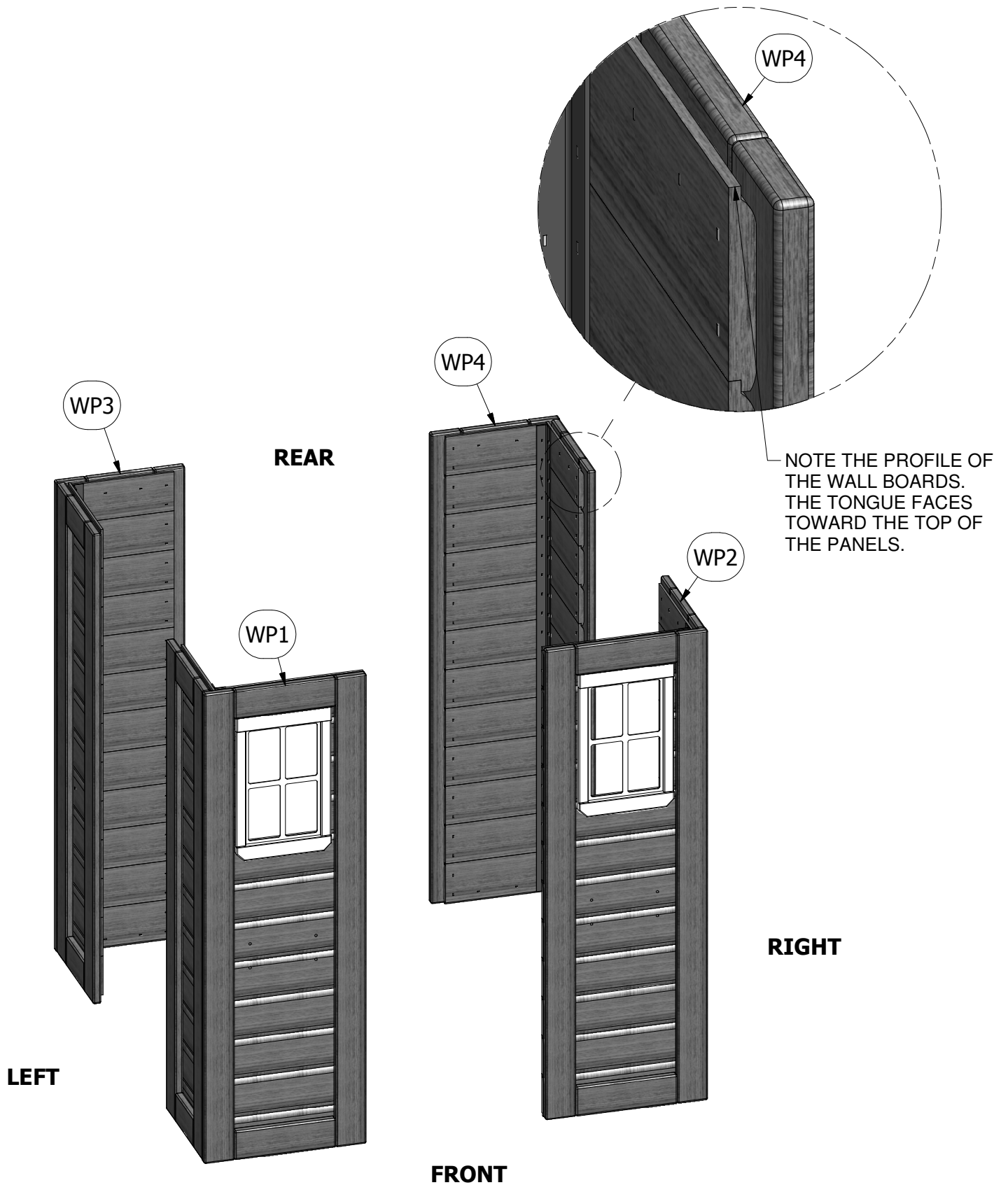

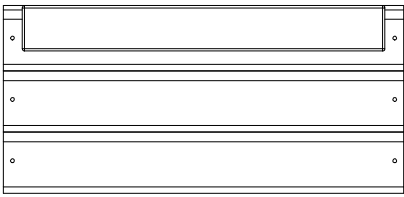

(1) WP6 - UPPER CENTER WALL
- W2A01510

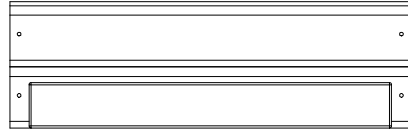

(1) WP5 - LOWER CENTER WALL
- W2A01509

STEP 2:

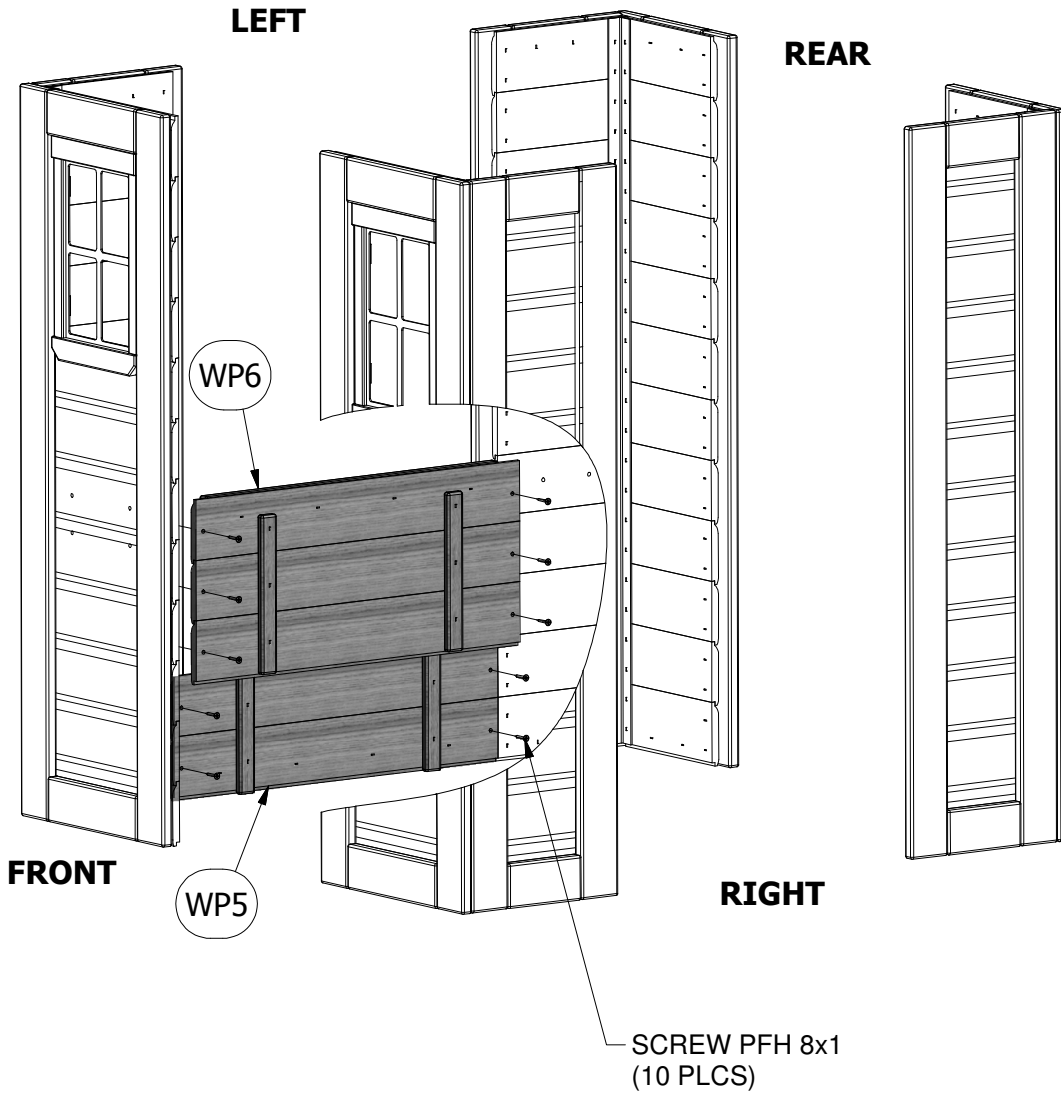
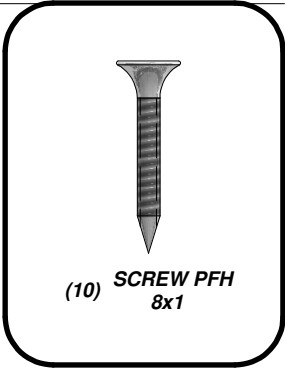

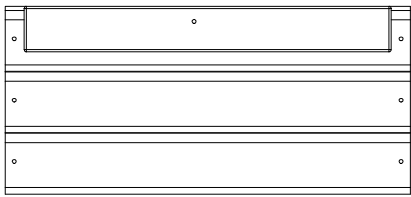

(1) WP7 - UPPER REAR CENTER WALL
- W2A01522

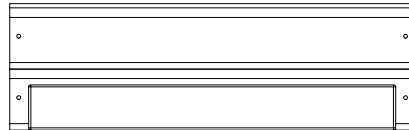

(1) WP8 - LOWER REAR CENTER WALL
- W2A01523

STEP 3:

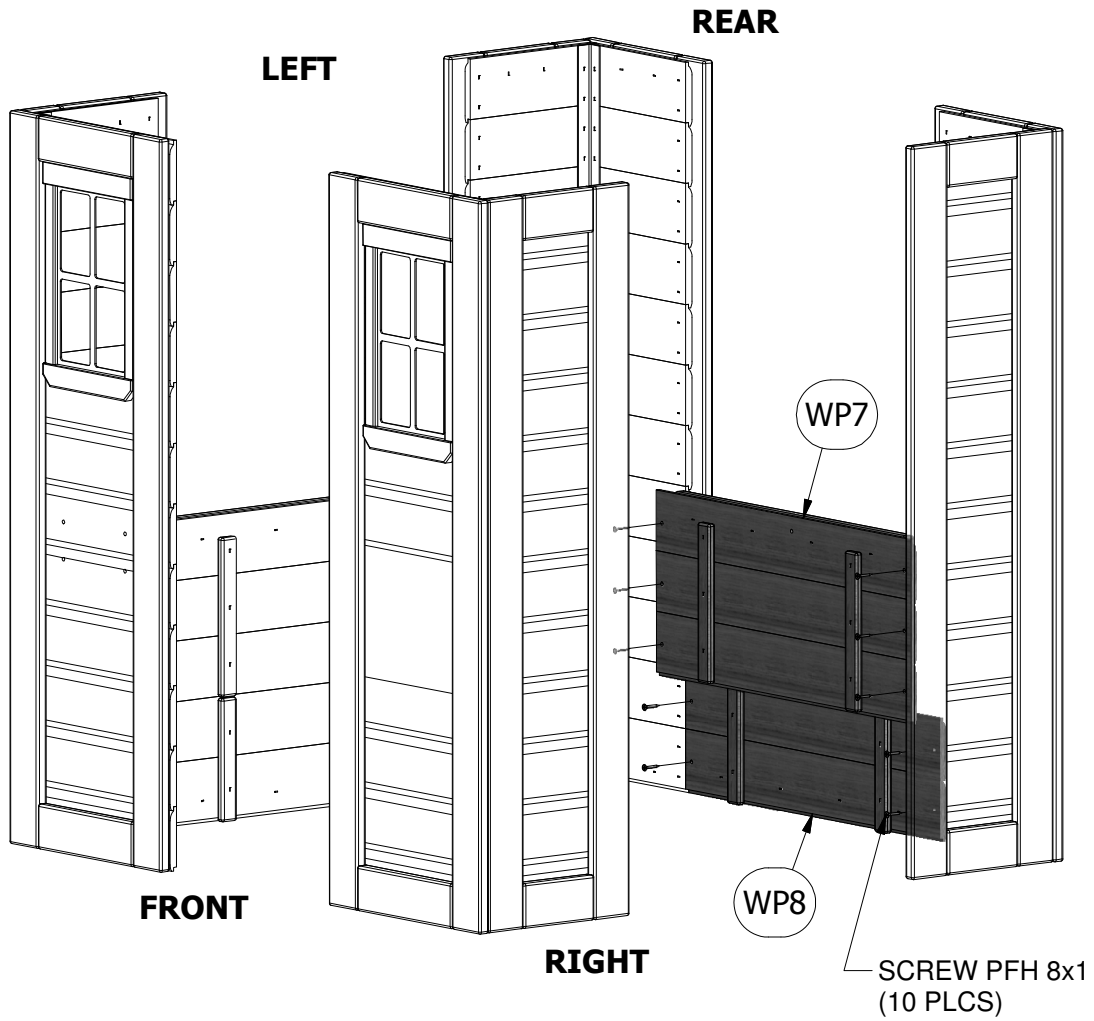
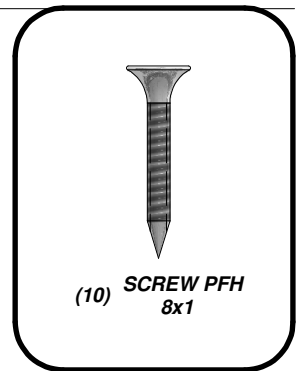

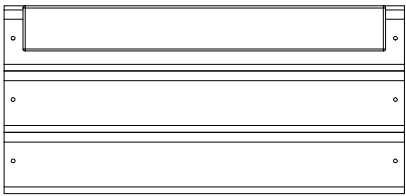

(1) WP6 - UPPER CENTER WALL
- W2A01510

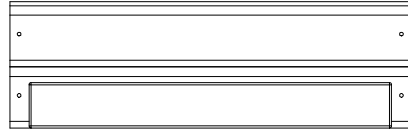

(1) WP5 - LOWER CENTER WALL
- W2A01509

STEP 4:

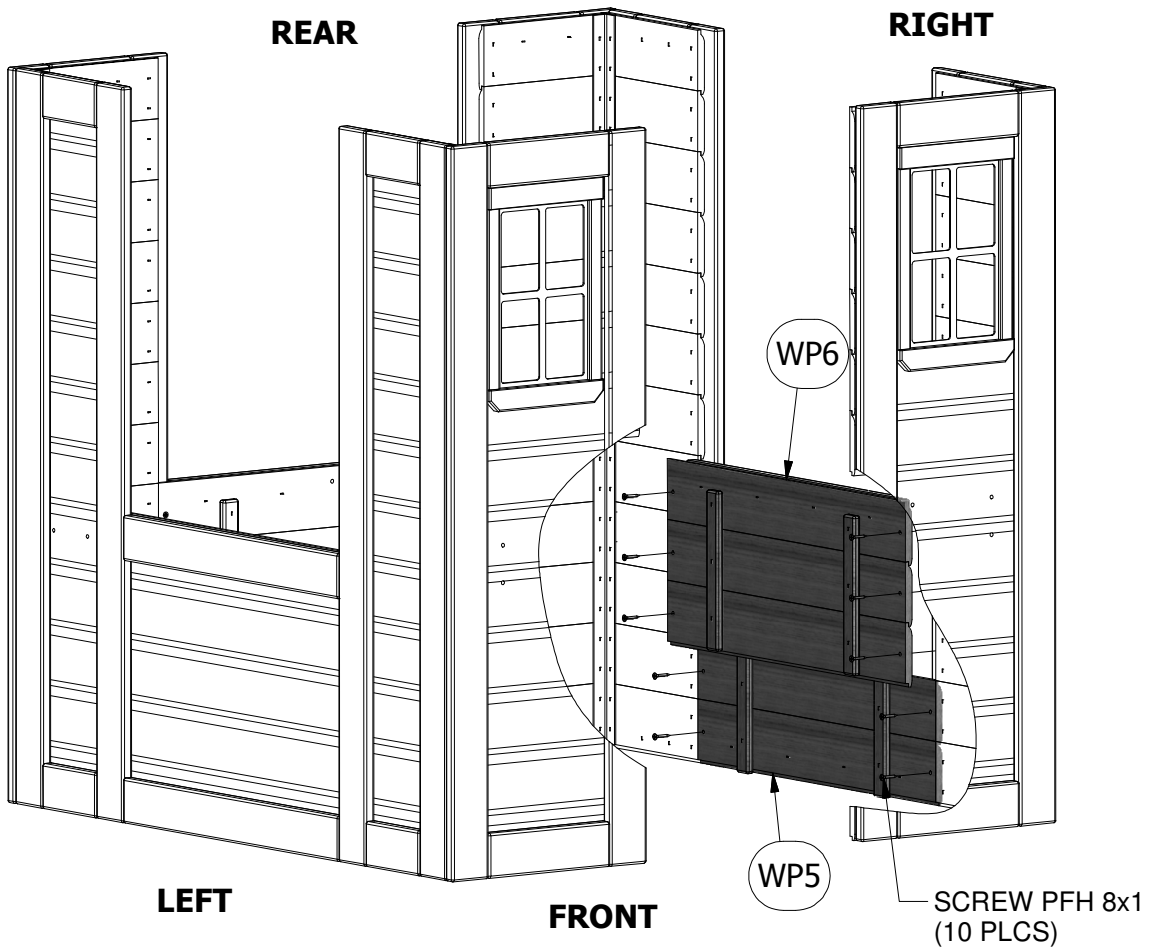
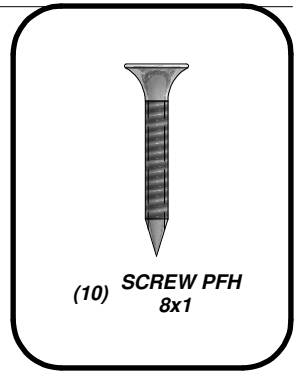

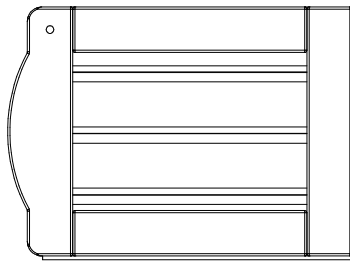

(1) DP1 - DOOR ASSEMBLY - W2A01511

STEP 5:

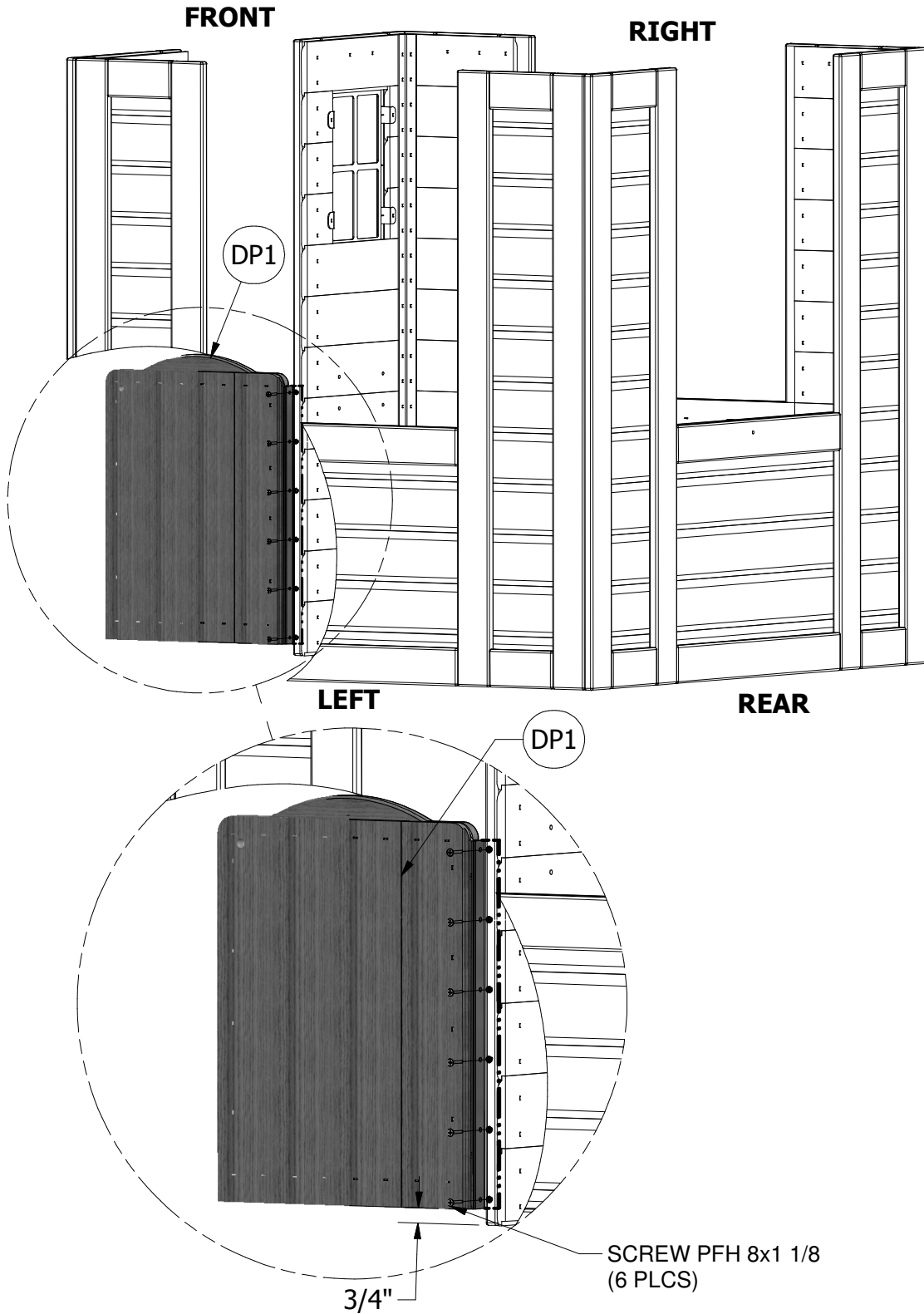
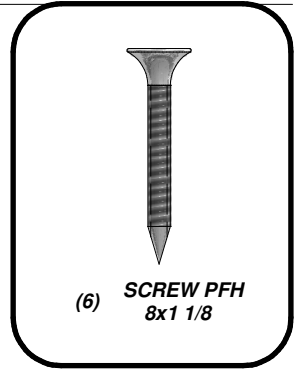

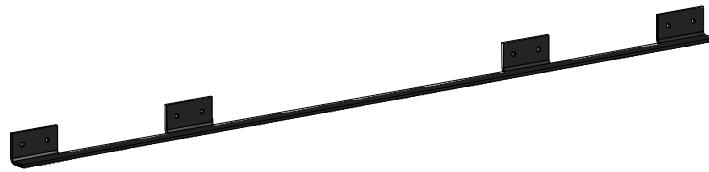

(1) METAL TIE STRAP - A4M00517

STEP 6:

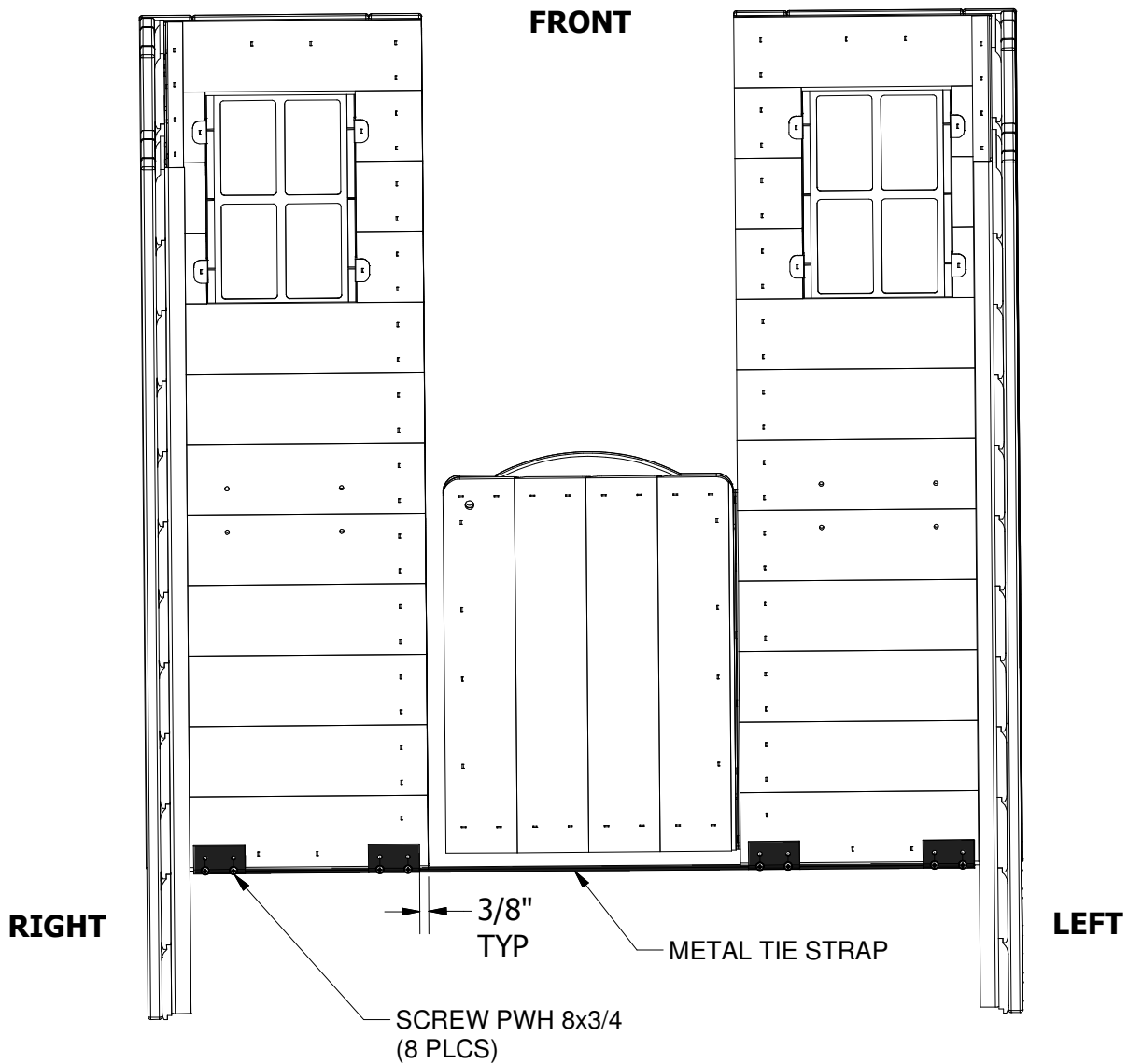
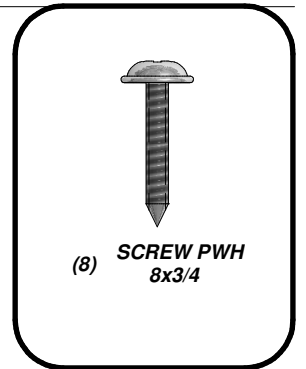

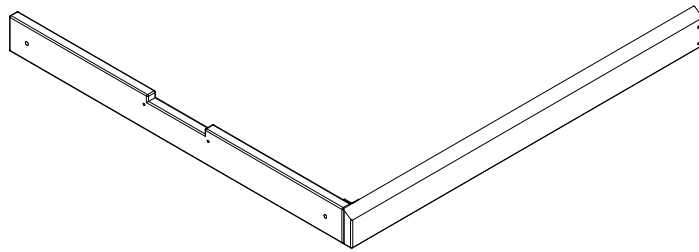

(2) WP9 - HEADER ASSEMBLY - W2A01512

STEP 7:

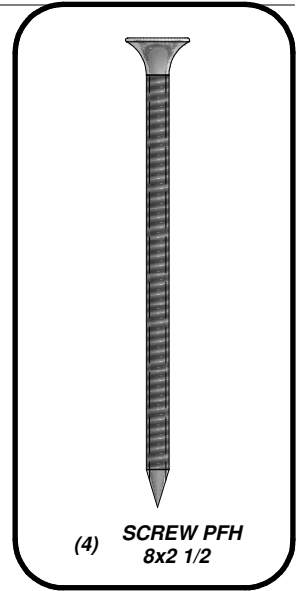
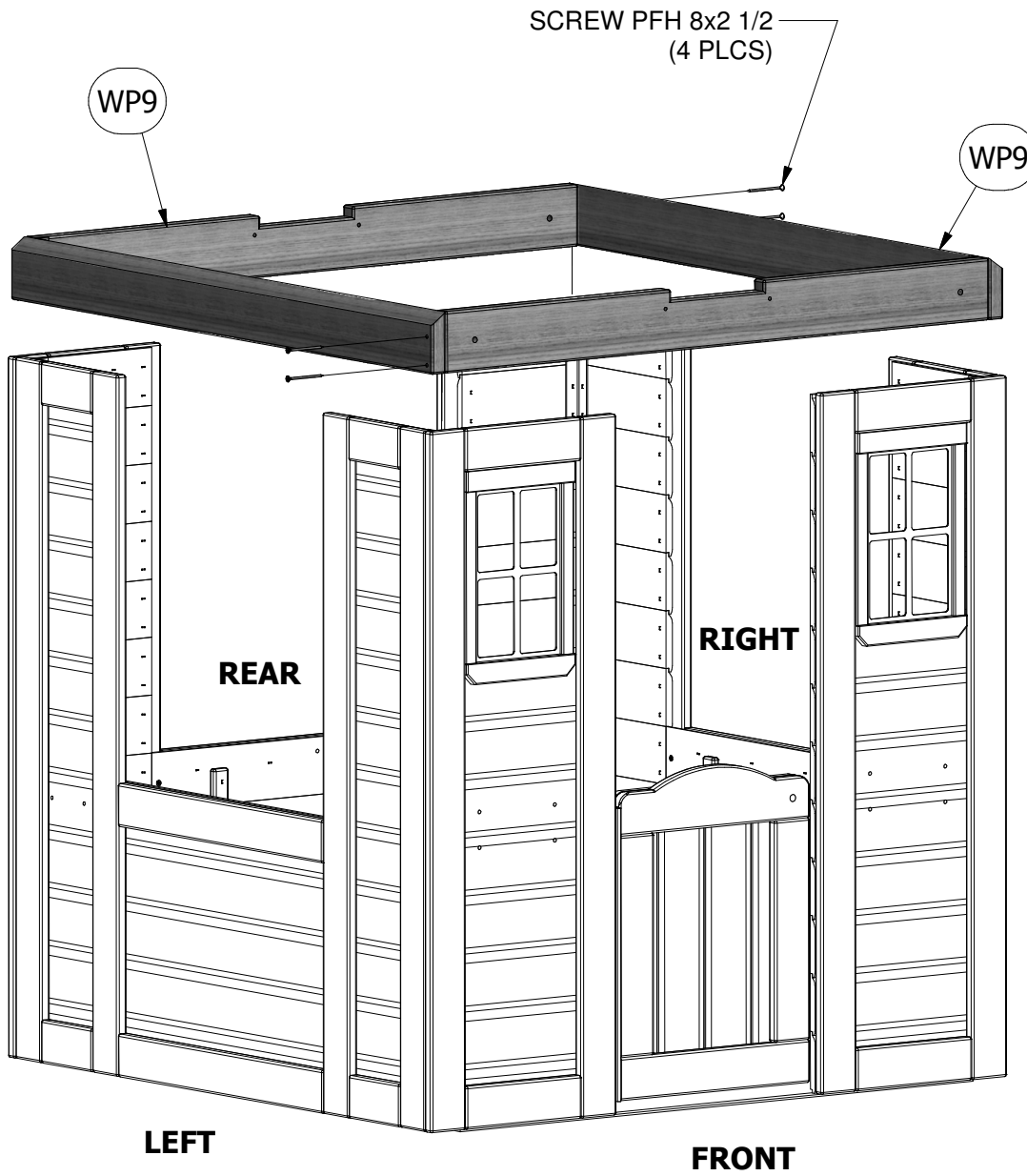

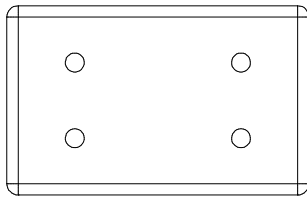

(8) **N4 - TIE STRAP - W102424**
5/8"x2"x3 1/8" (16x50x80)

STEP 8:

SCREW PFH 8x1 1/4
(32 PLCS)

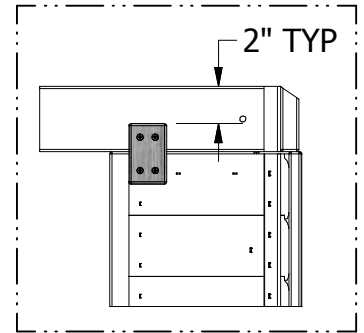
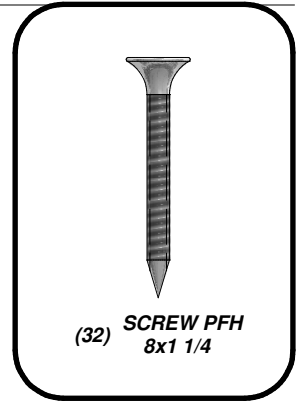
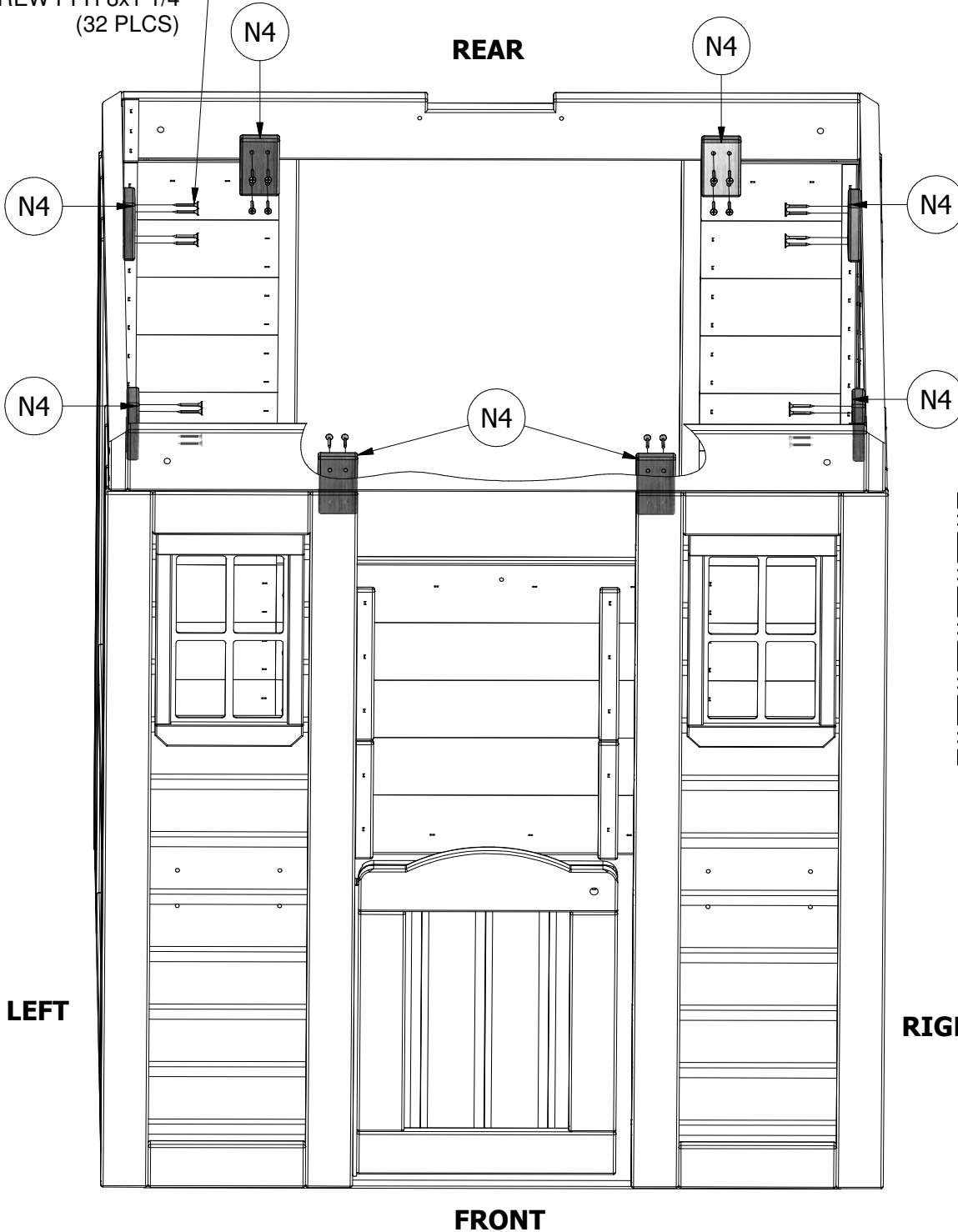

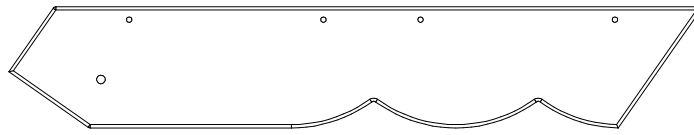

(4) **L1 - GABLE BOARD - W4L04755**
5/8"x4 3/8"x25 3/8" (16x112x643)

STEP 9:

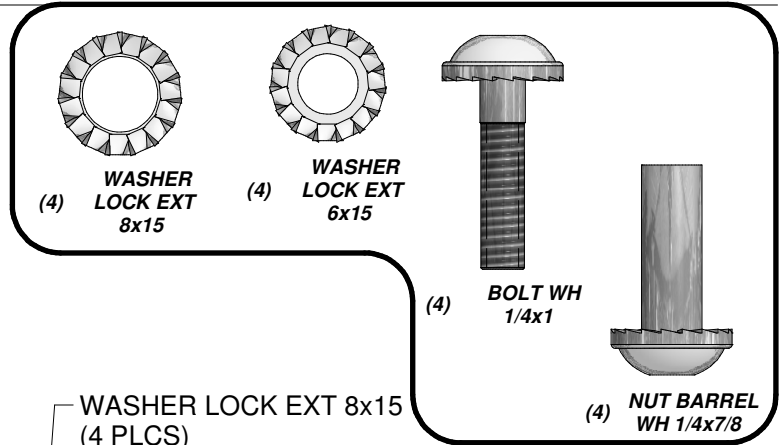

WASHER LOCK EXT 6x15
(4 PLCS)

BOLT WH 1/4x1
(4 PLCS)

WASHER LOCK EXT 8x15
(4 PLCS)

NUT BARREL WH 1/4x7/8
(4 PLCS)

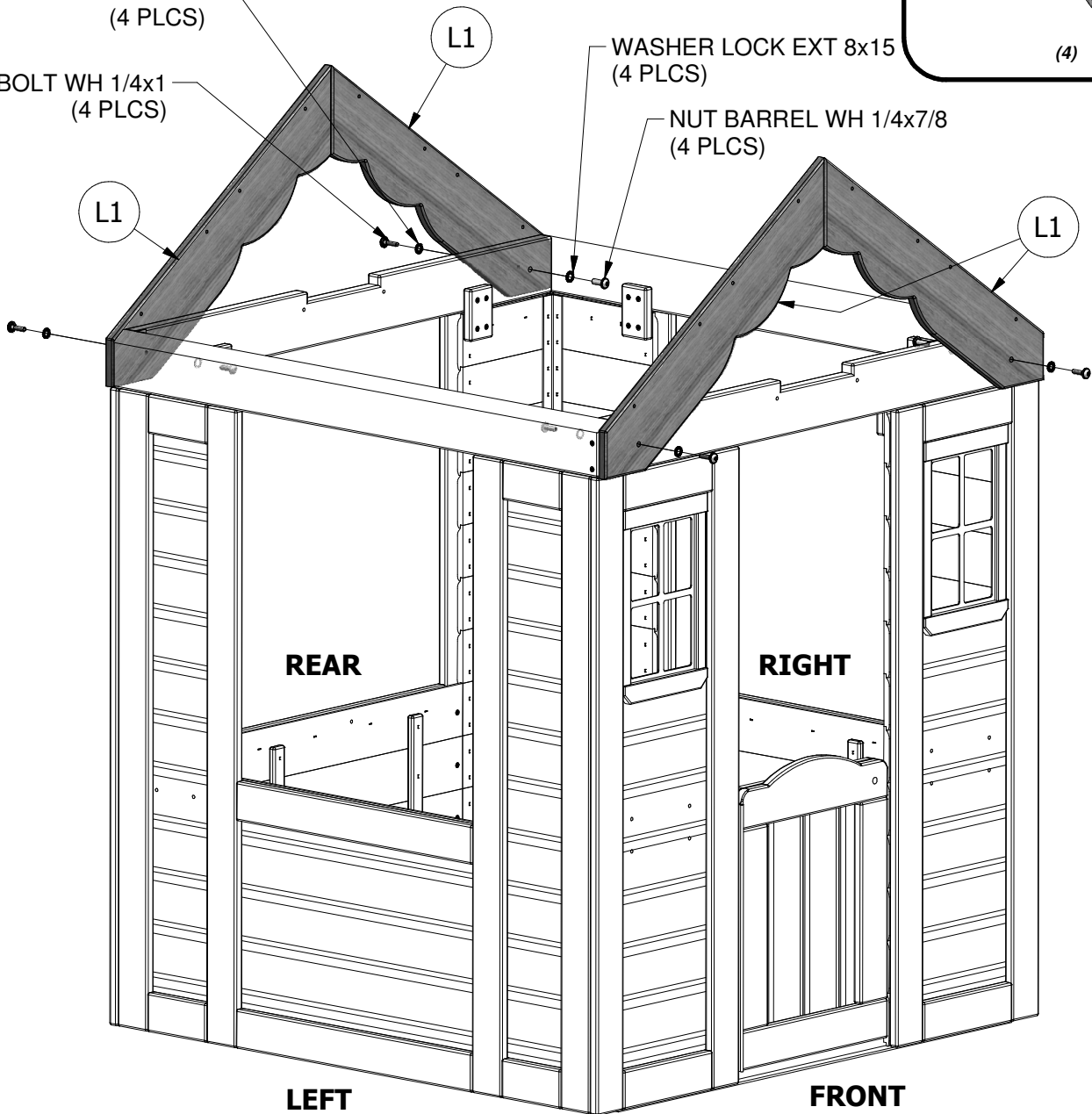

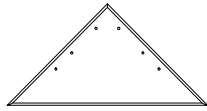

(2) **K1 - TRIANGLE SUNBURST - W4L04871**
 5/8"x5 1/4"x10 3/8" (16x134x265)



(2) **N5 - SUNBURST LEG - W4L04872**
 5/8"x2 3/8"x10 1/4" (16x60x260)



(4) **N6 - SUNBURST LEG - W4L04873**
 5/8"x2 3/8"x8 1/4" (16x60x210)

STEP 10:

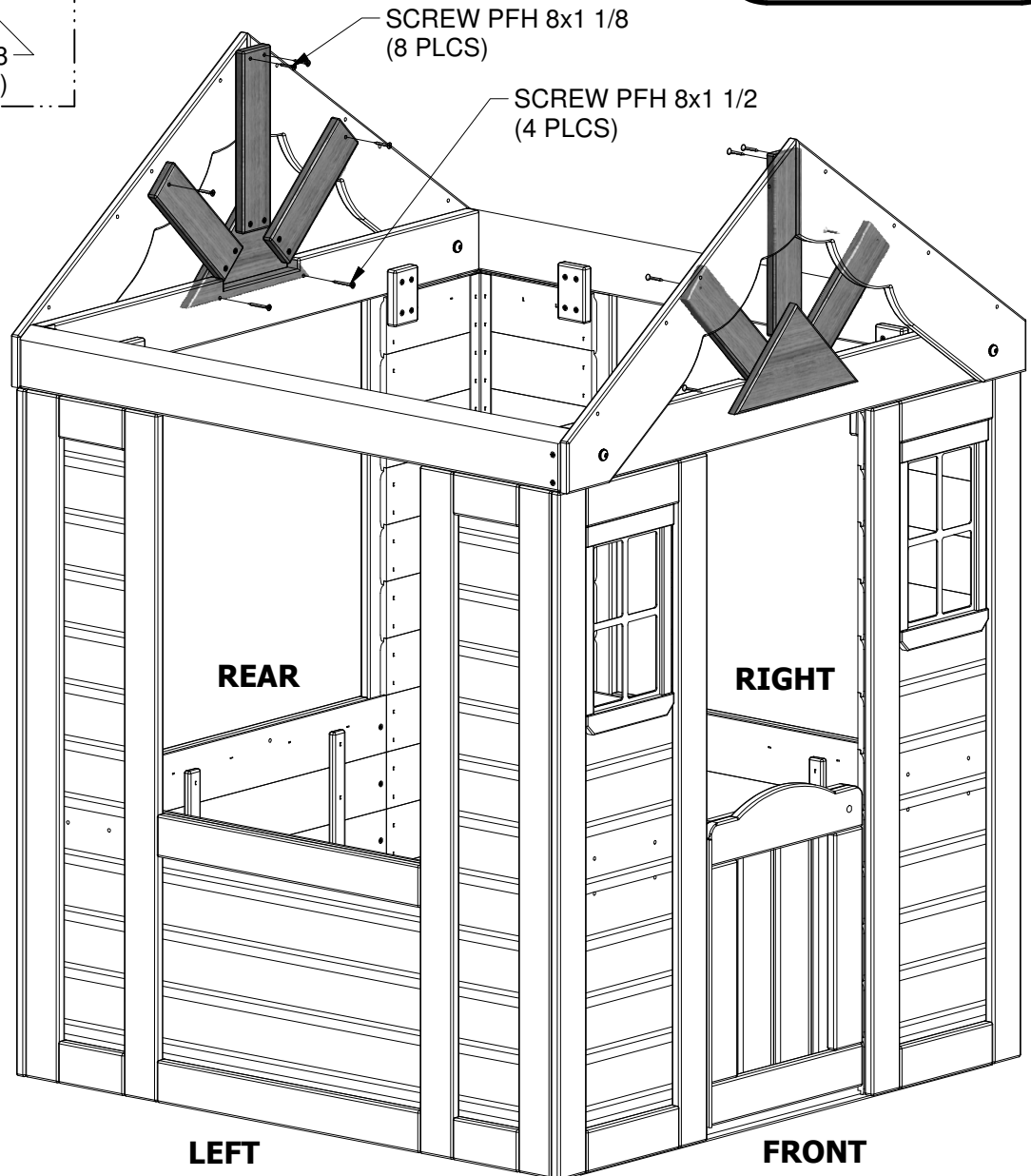
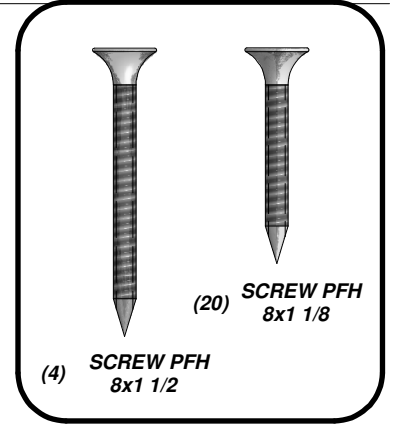
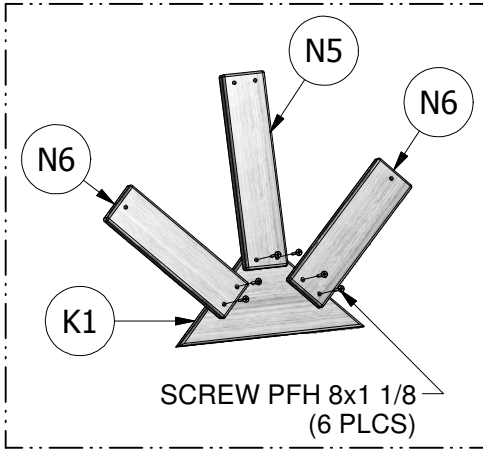

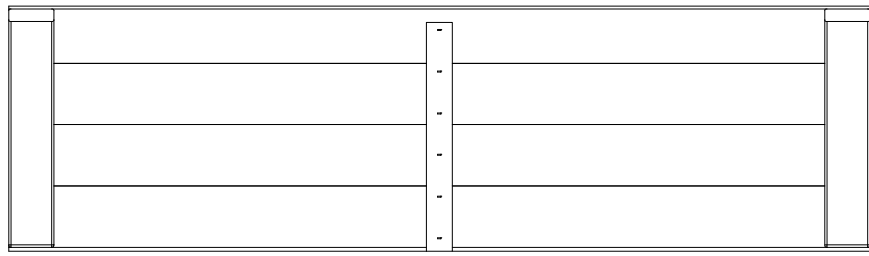

(2) RP2 - UPPER ROOF PANEL - W2A01514

STEP 11:

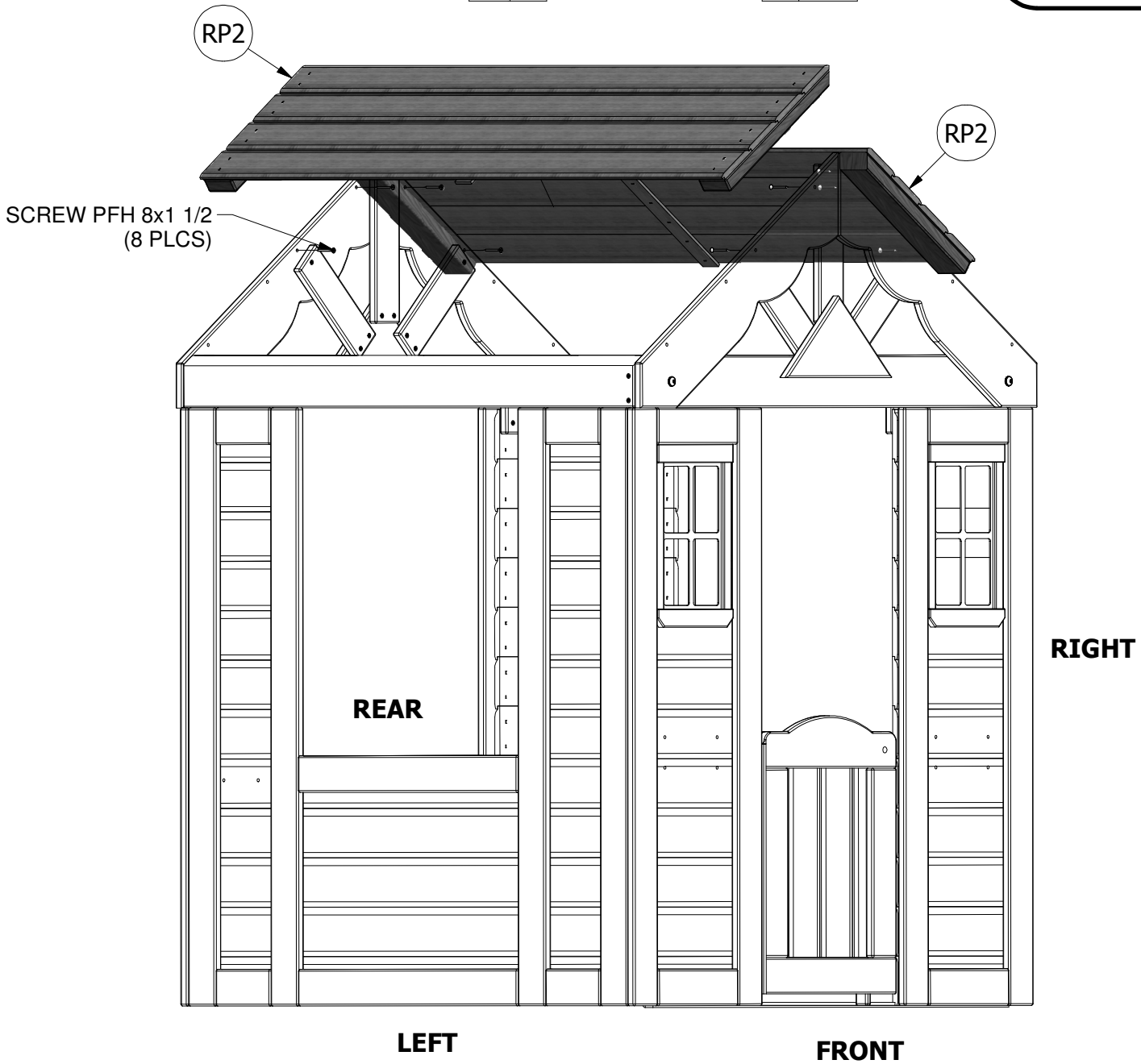
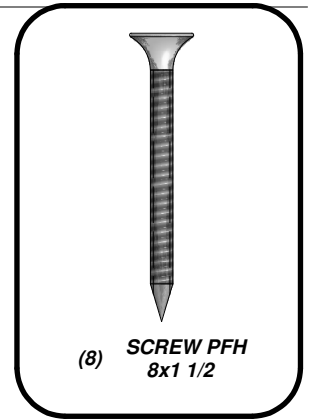
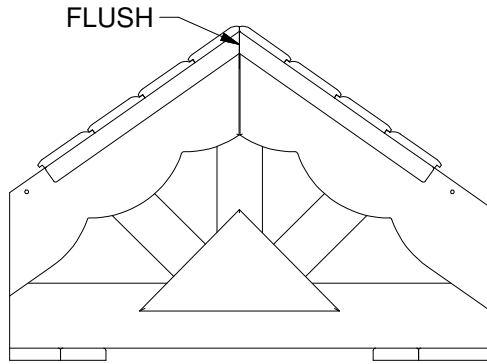

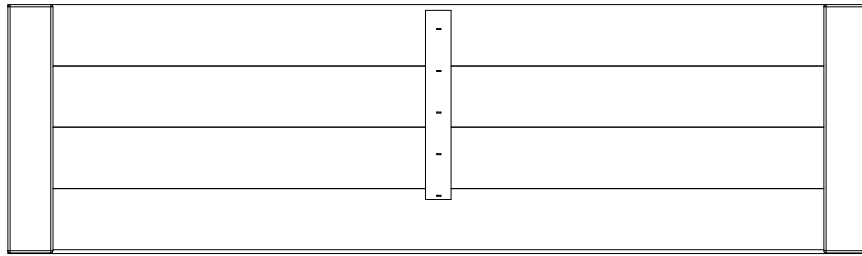

(2) RP1 - LOWER ROOF PANEL - W2A01513

STEP 12:

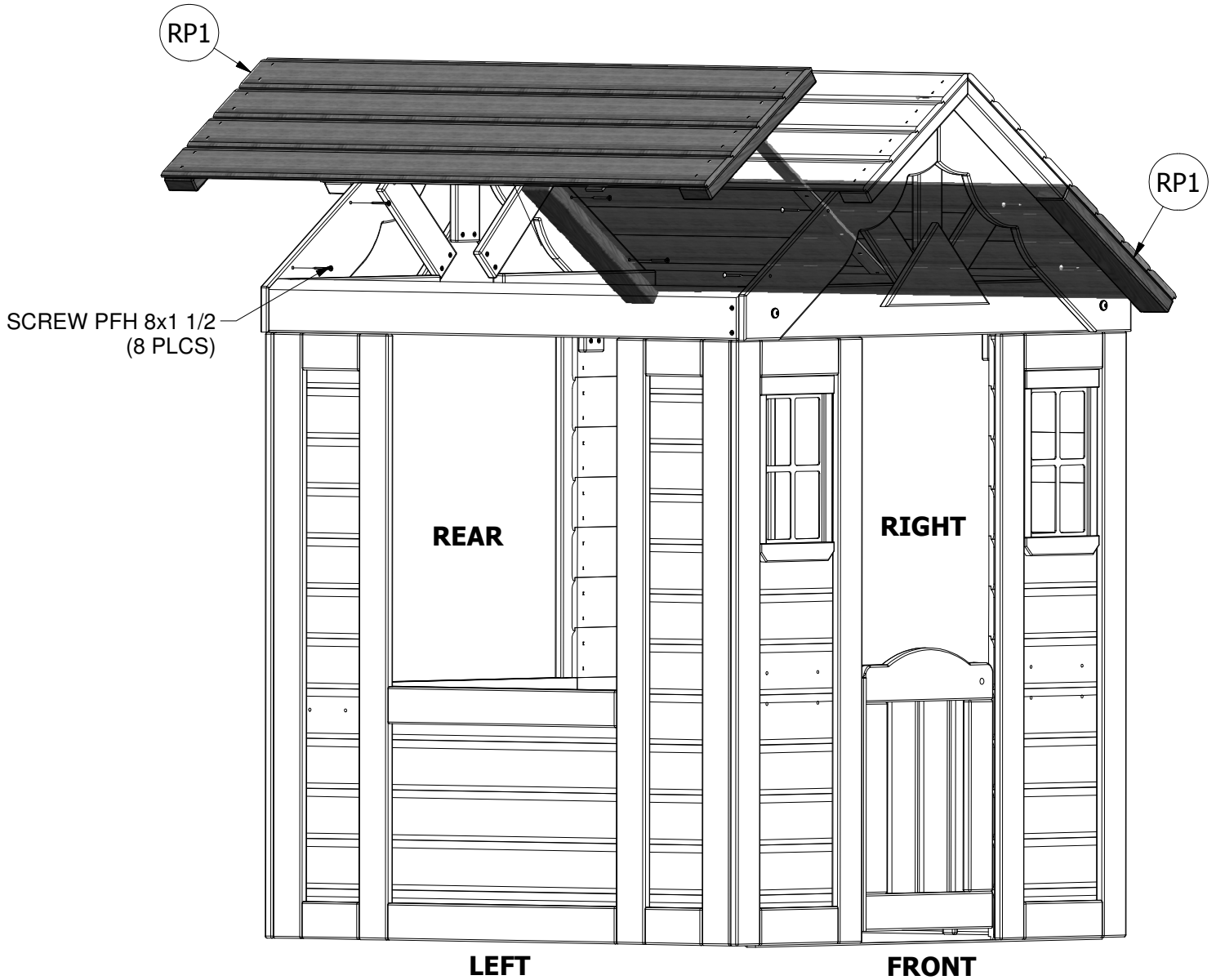
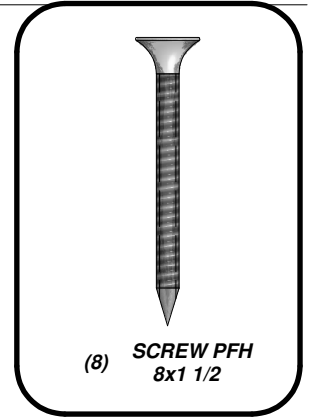

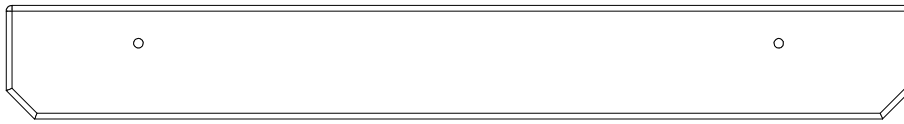

(1) **N1 - SIDE WINDOW SHELF - W4L04751**
5/8"x2 3/8"x18 7/8" (16x60x479)

STEP 13:

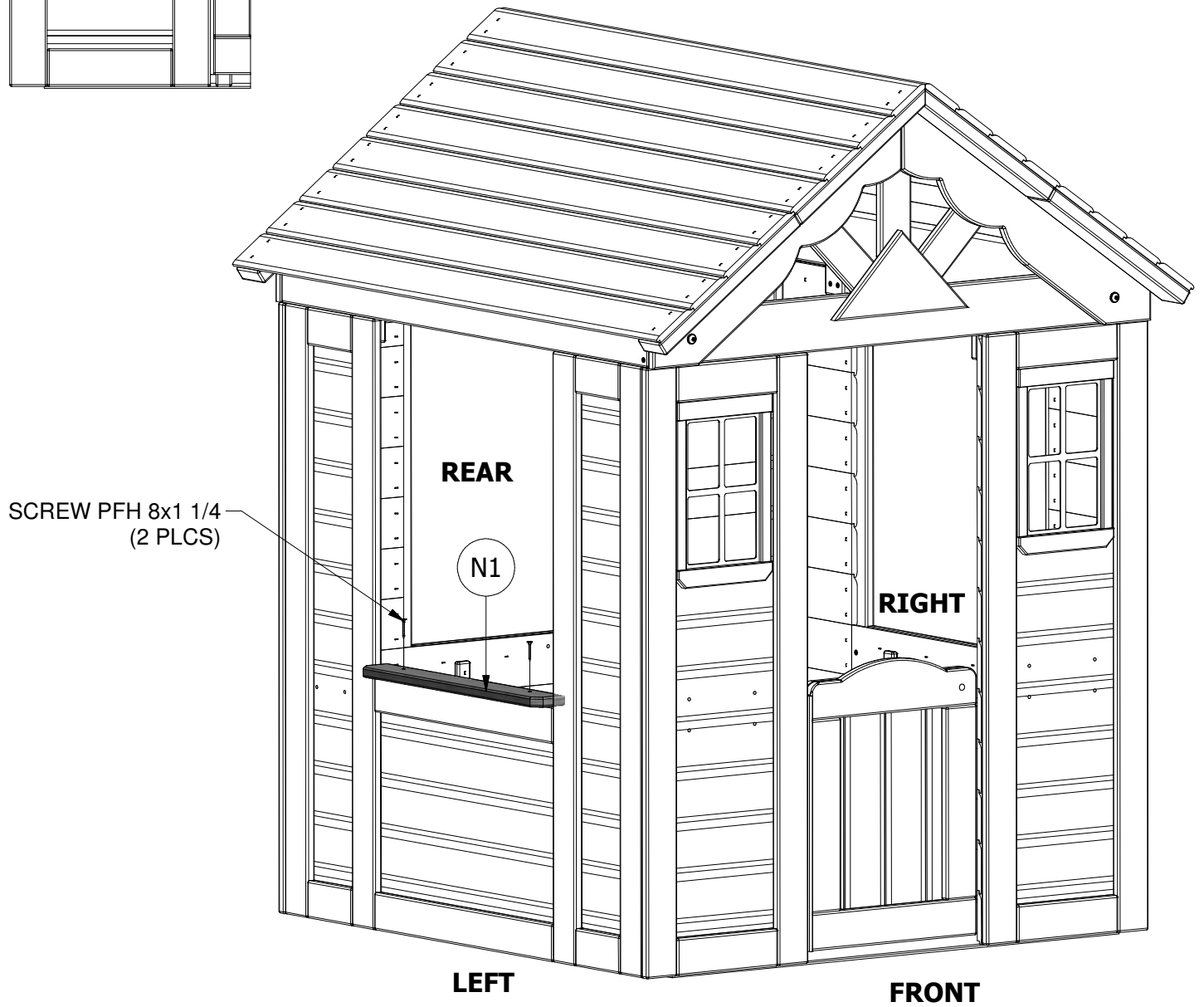
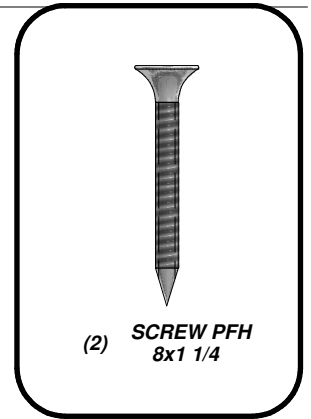
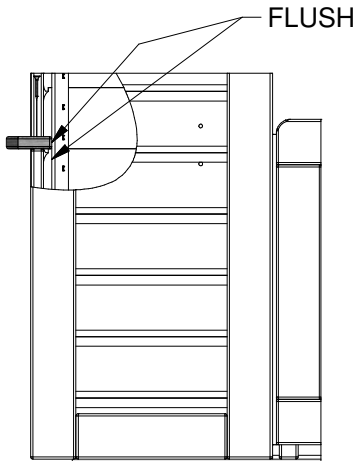

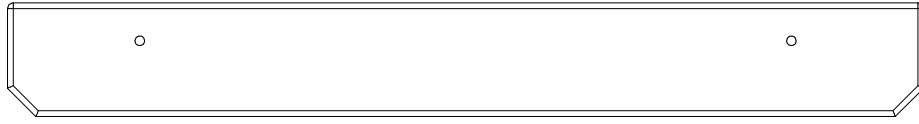

(1) **N2 - REAR WINDOW SHELF - W4L04760**
5/8"x2 3/8"x19 1/8" (16x60x485)

STEP 14:

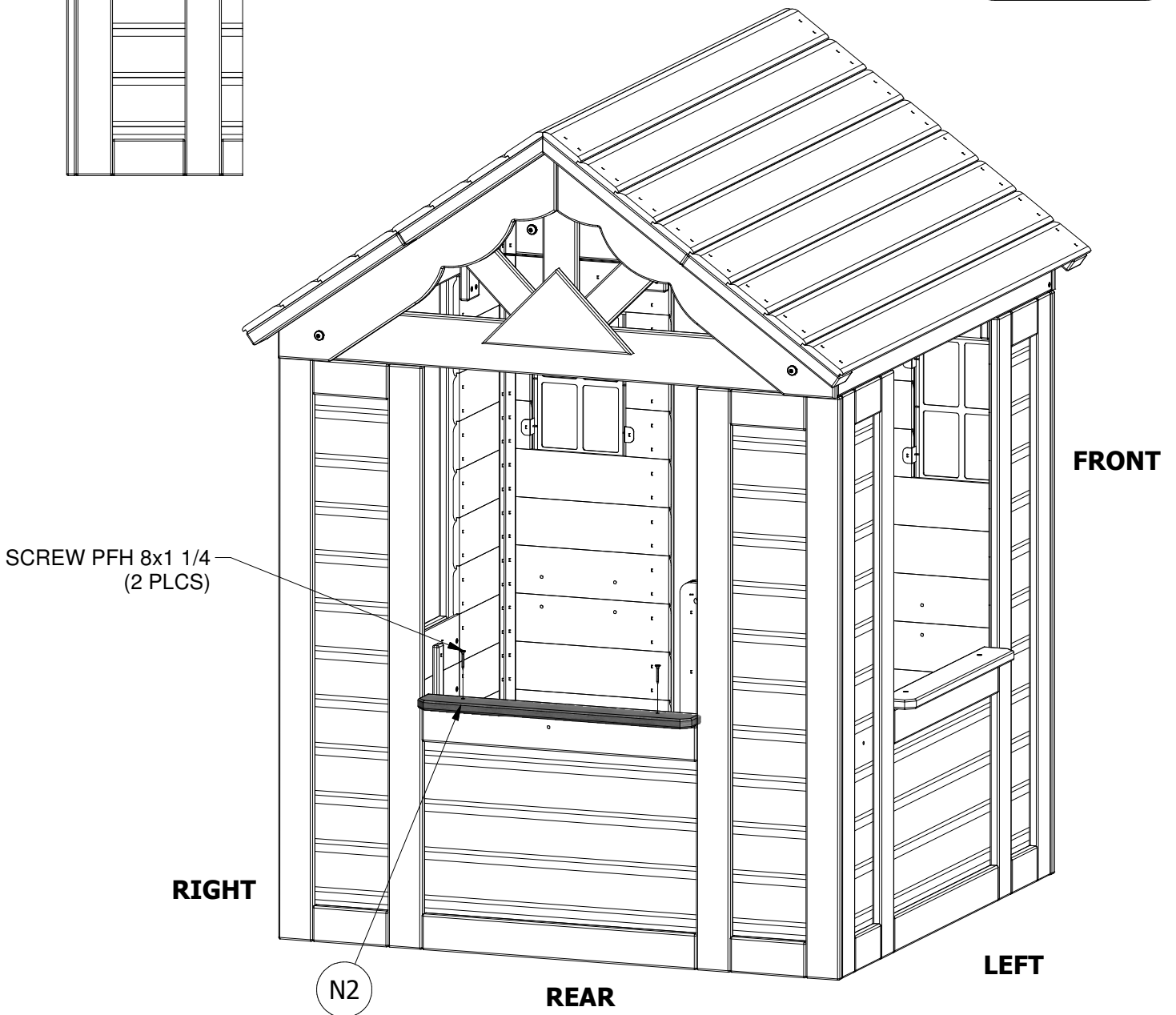
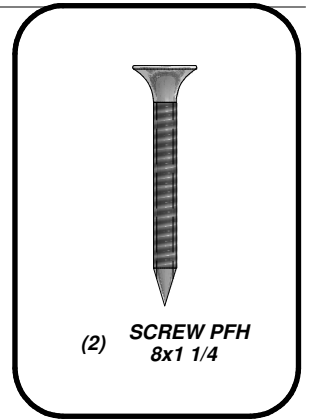
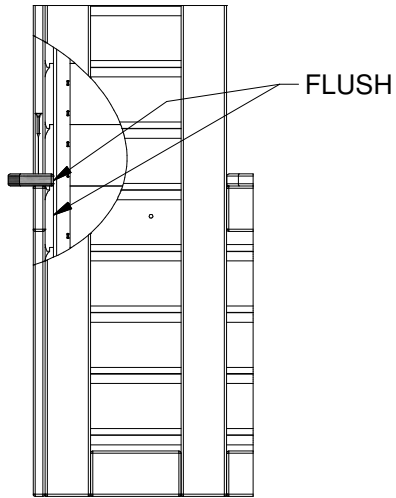

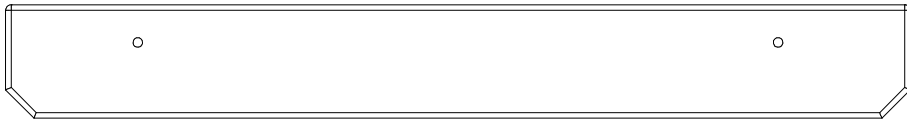

(1) **N1 - SIDE WINDOW SHELF - W4L04751**
5/8"x2 3/8"x18 7/8" (16x60x479)

STEP 15:

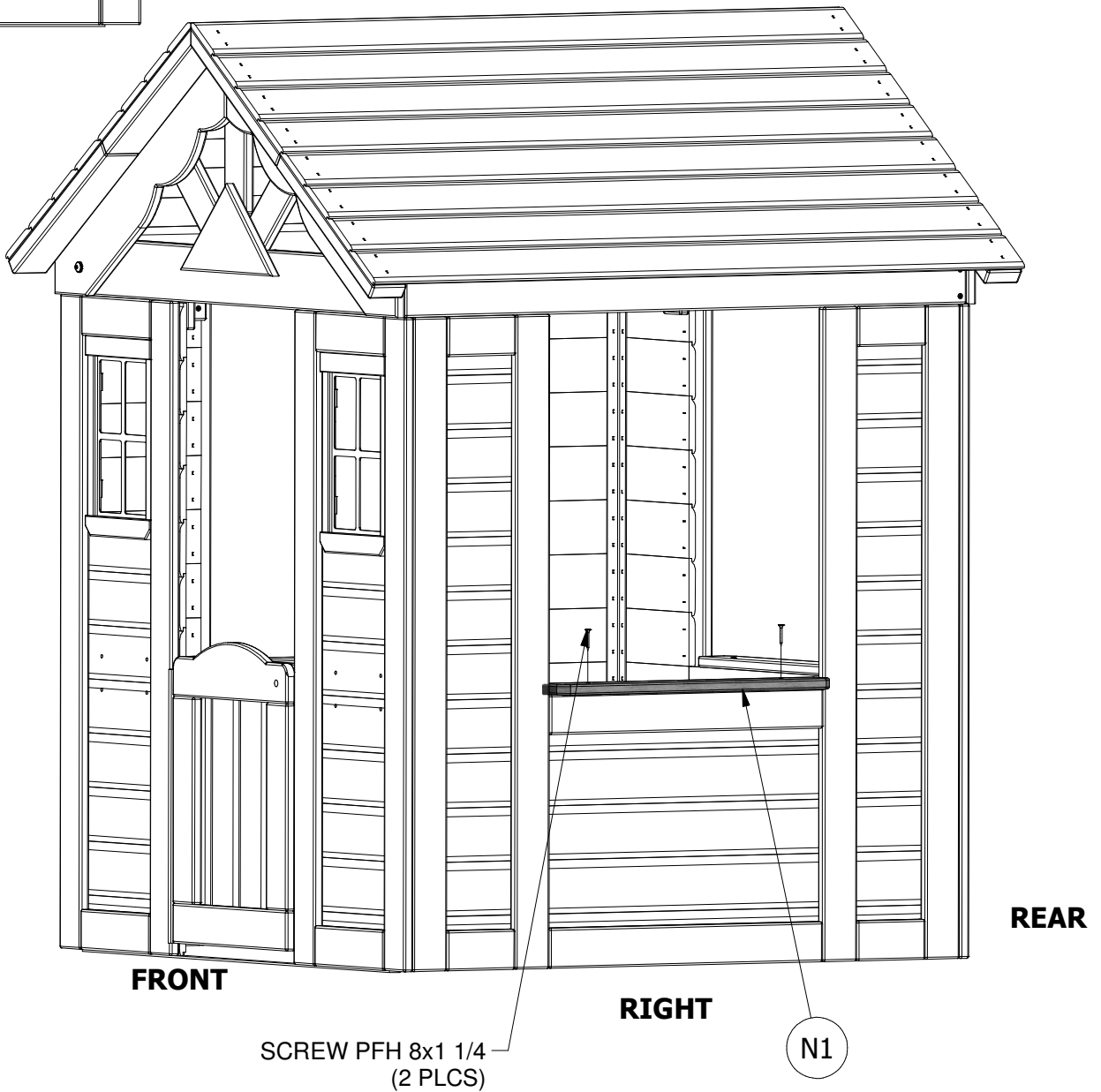
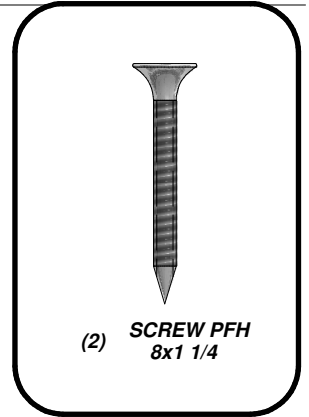
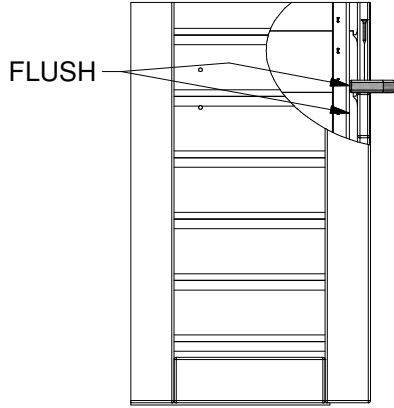

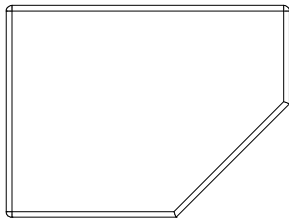

(1) **Q1 - COUNTER TOP SUPPORT - W4L04752**
1"x4 3/8"x5 7/8" (24x112x150)

STEP 16:

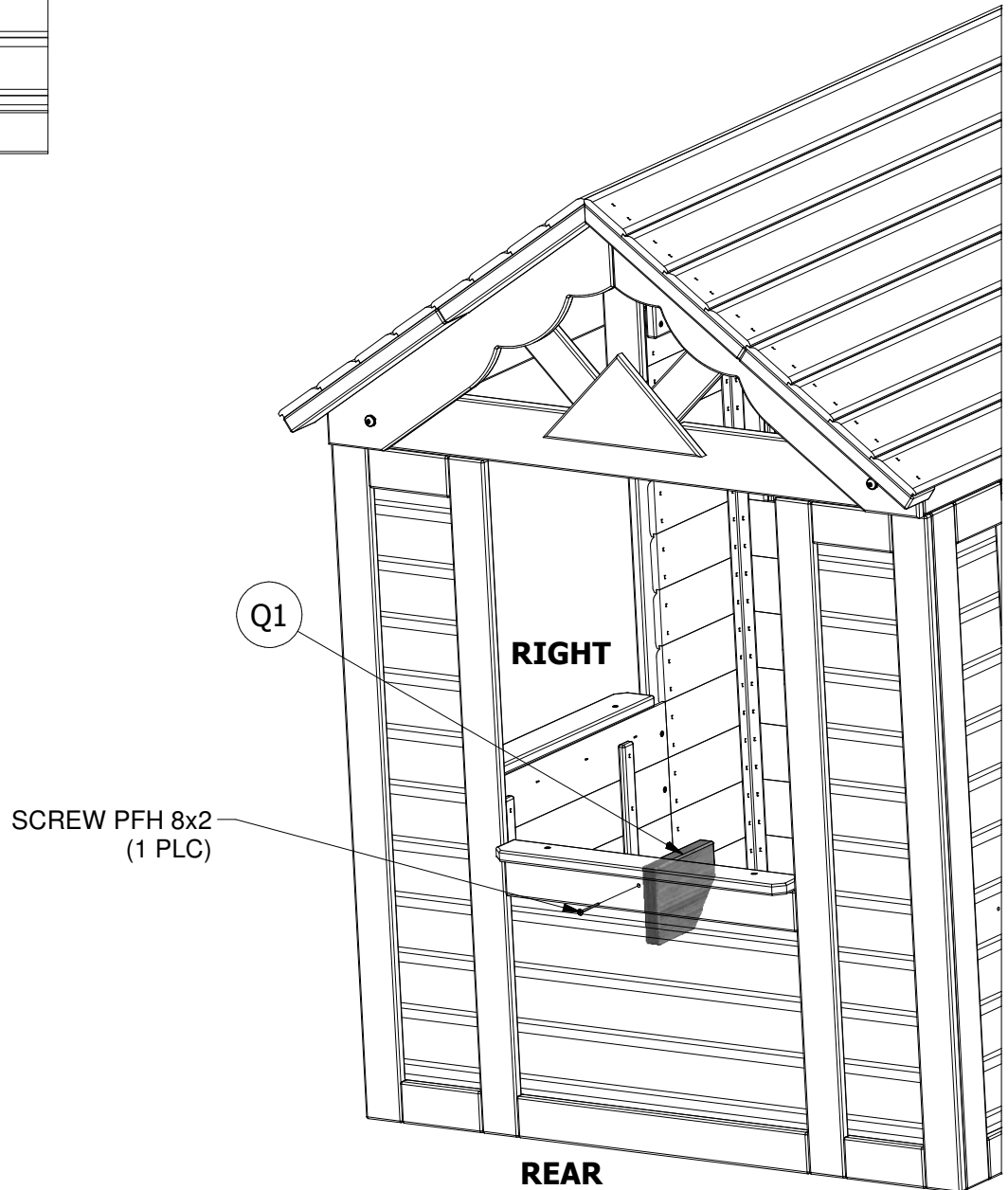
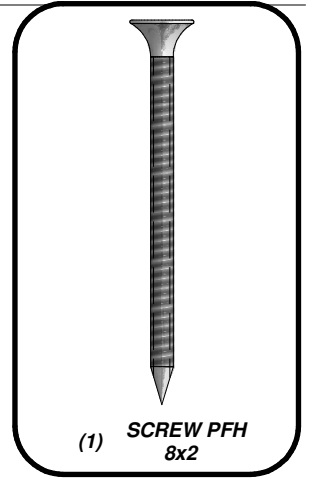
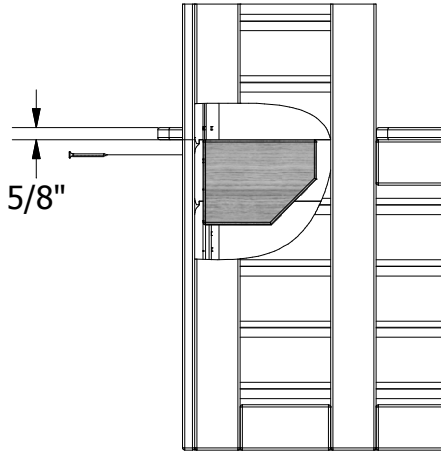

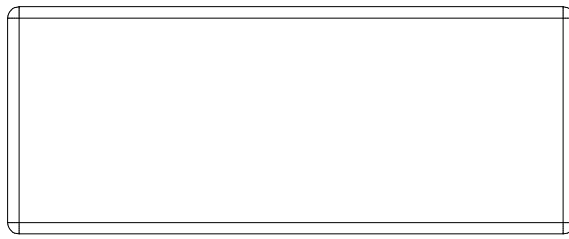

(1) **J1 - COUNTER TOP SUPPORT - W4L04753**
1"x2 3/8"x5 7/8" (24x60x150)

STEP 17:

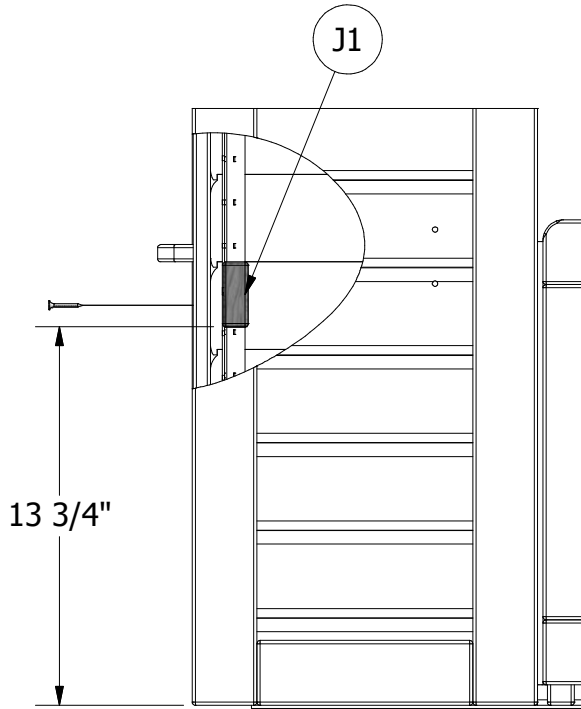

FRONT

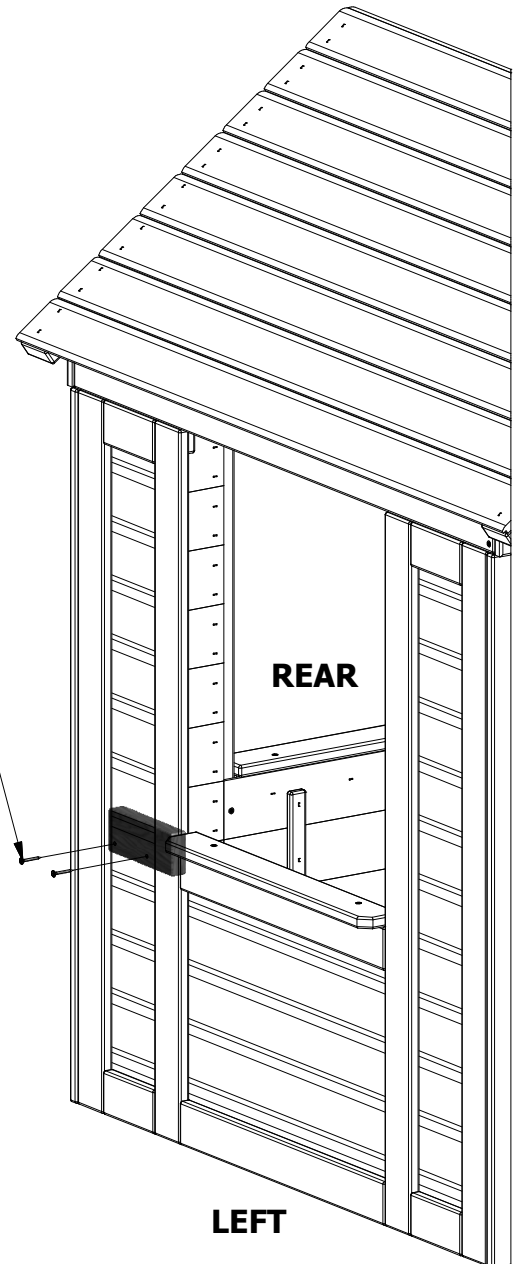
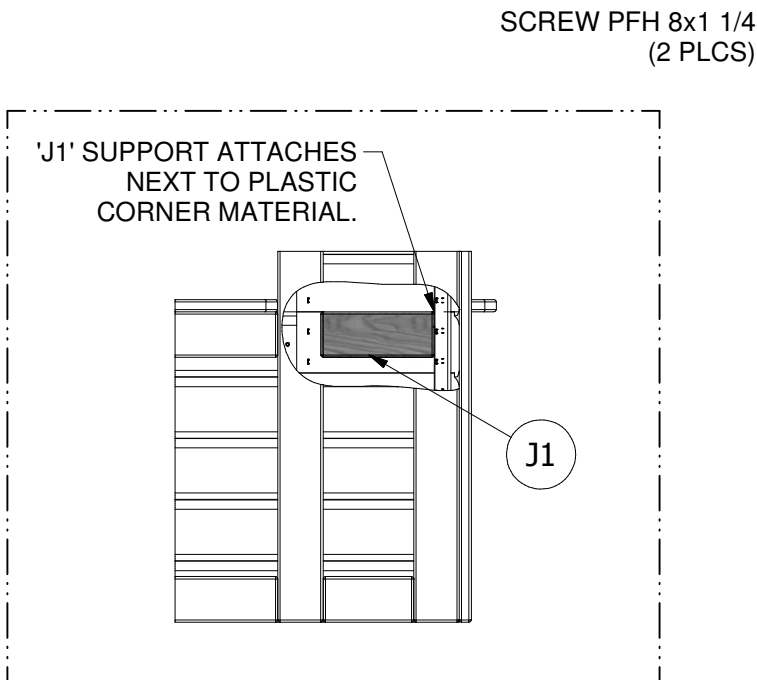
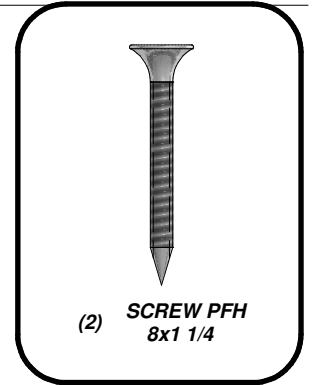

LEFT



(2) **M1 - COUNTER TOP - W4L04754**
5/8"x3 3/8"x23 5/8" (16x86x600)

STEP 18:

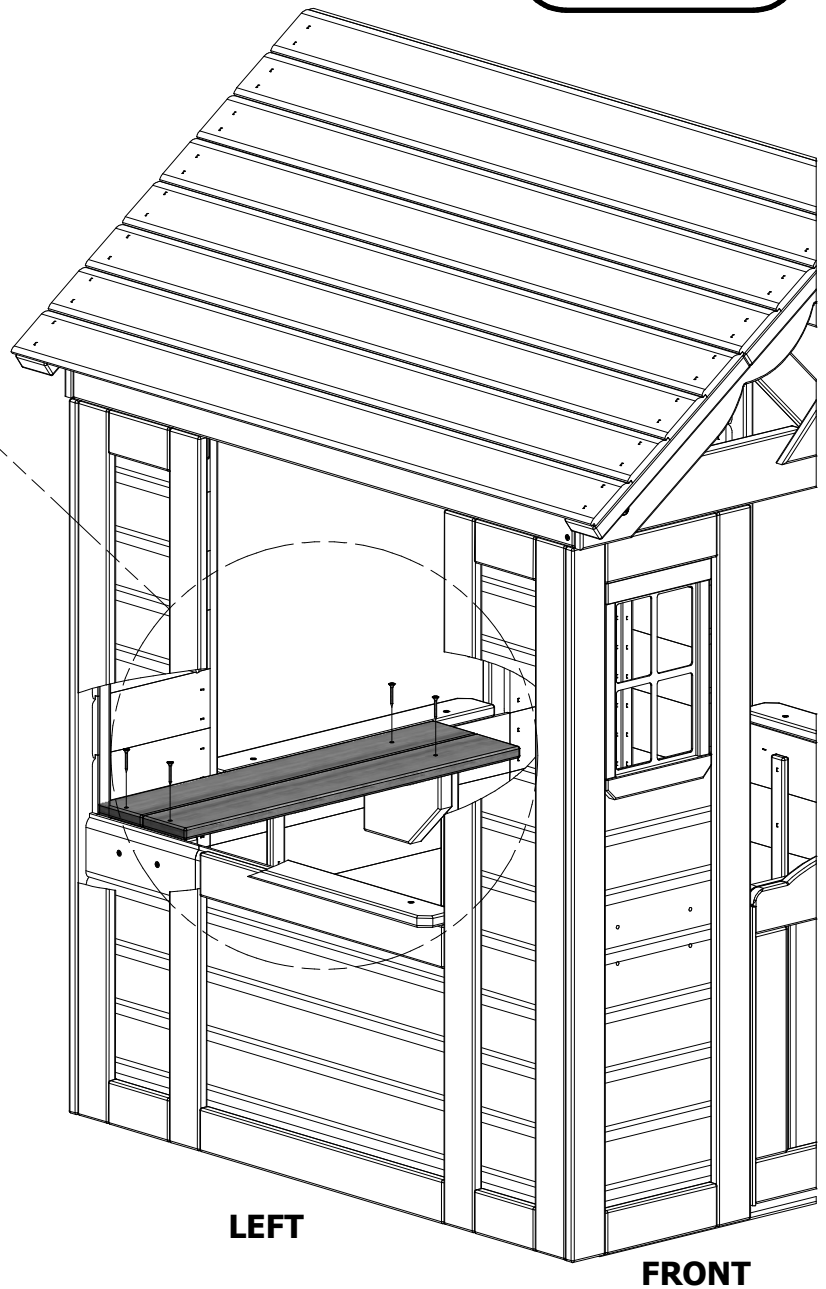
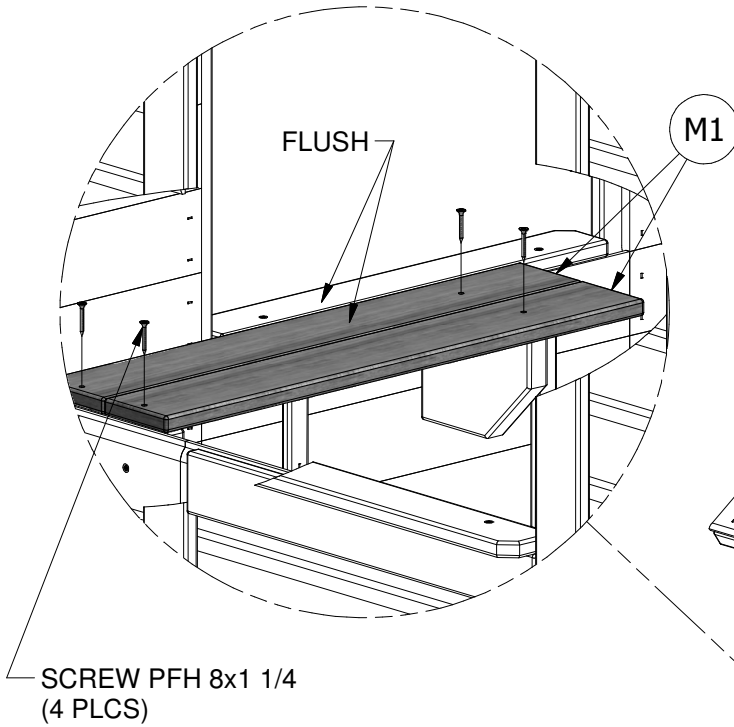
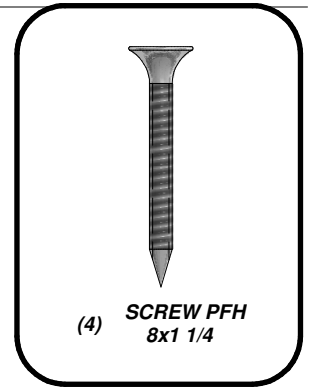

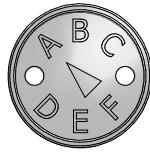

(1) "A" REVISION TAG - A100314

STEP 19:

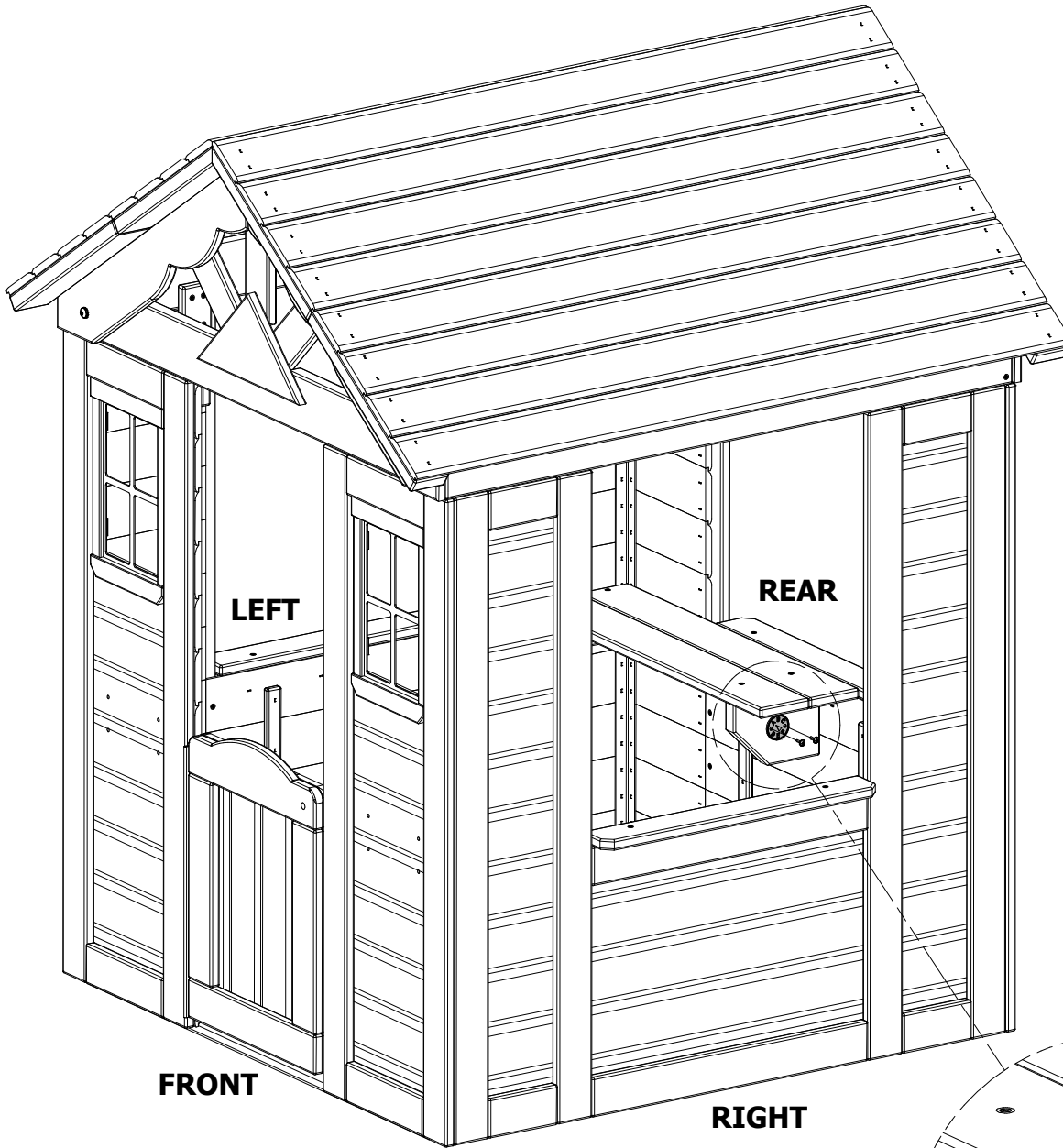
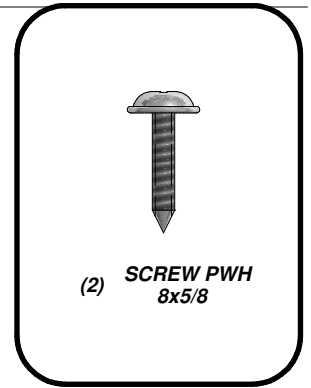

SCREW PWH 8x5/8
(2 PLCS)

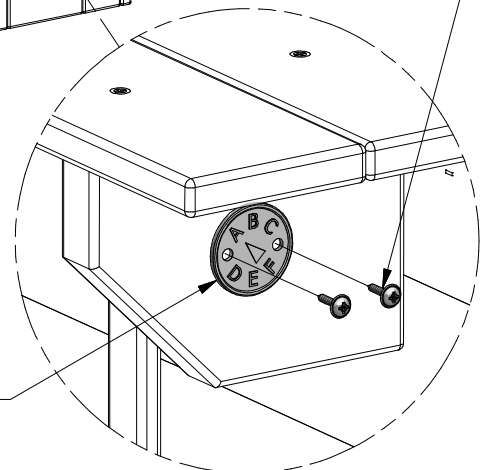

"A" REVISION TAG

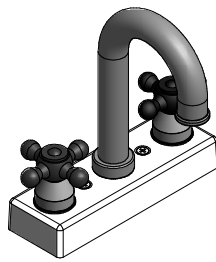

(1) FAUCET KIT - A6P00024

STEP 20:

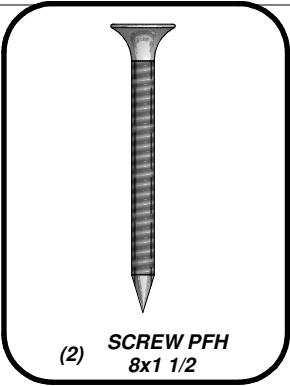
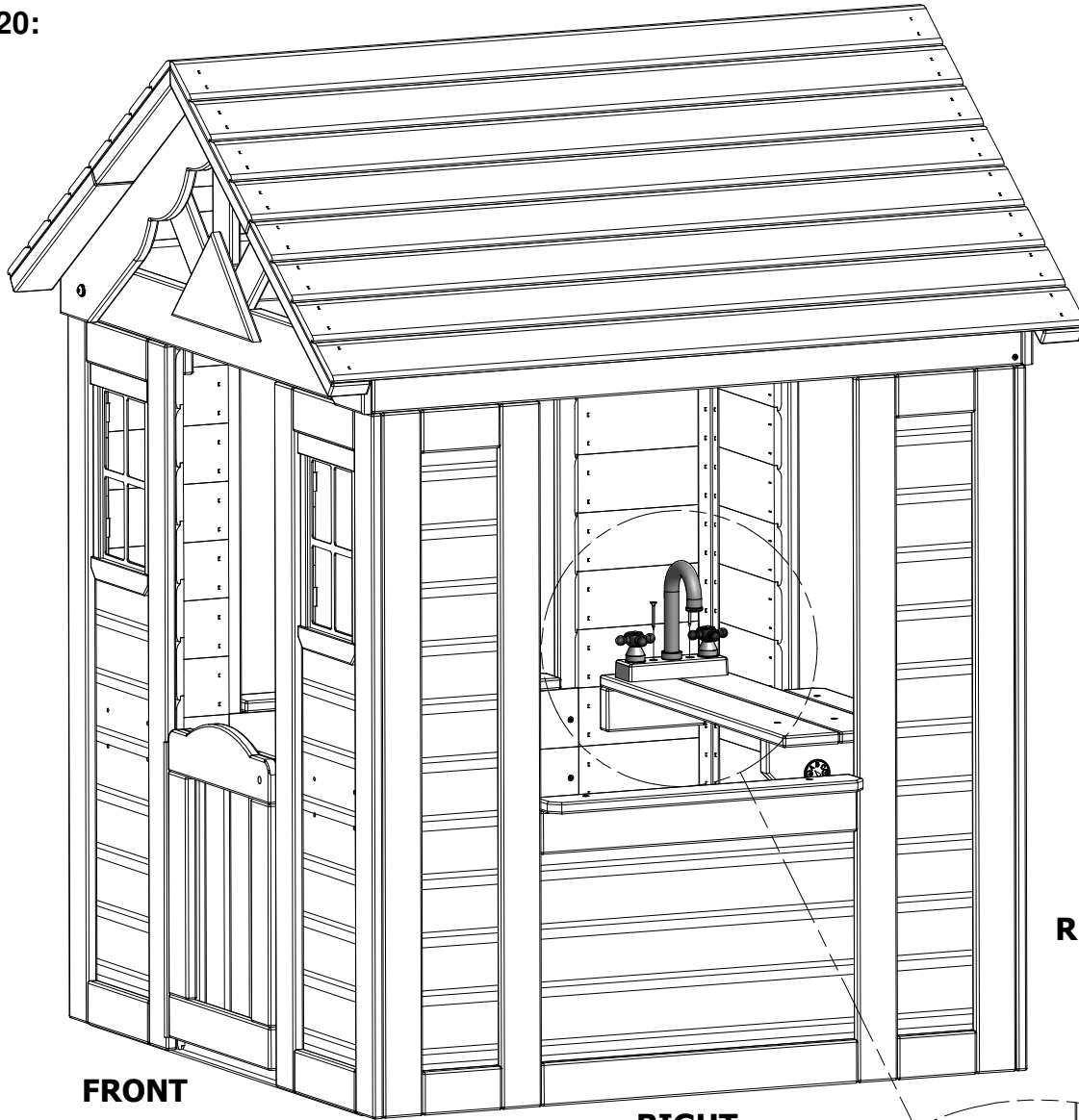

(2) SCREW PFH
8x1 1/2

FRONT

REAR

RIGHT

SCREW PFH 8x1 1/2
(2 PLCS)

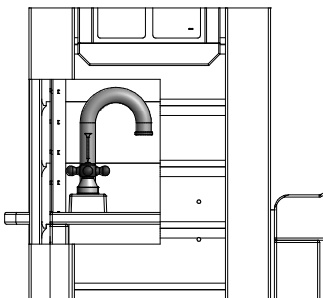

1"

FAUCET KIT

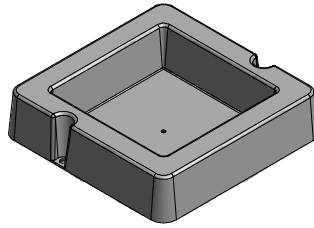

(1) SURFACE MOUNT BASIN - A6P00032

STEP 21:

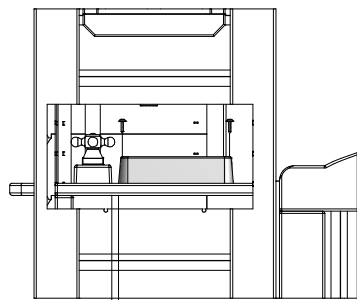
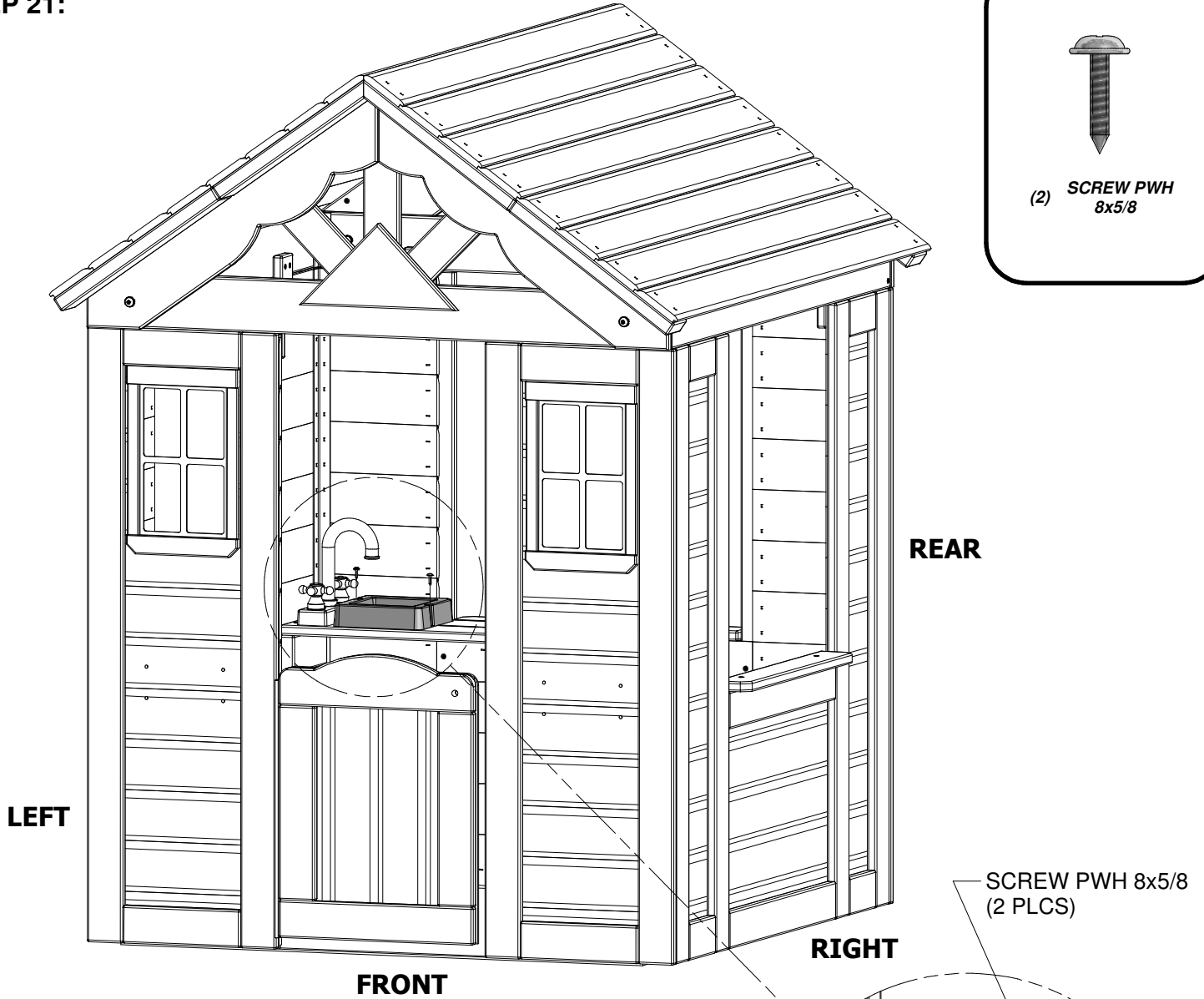
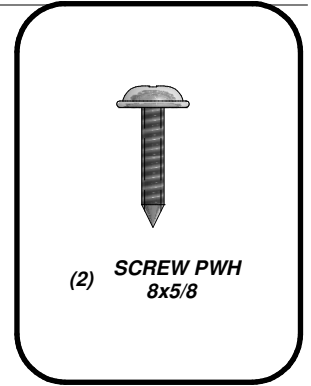

3/8" →

SURFACE MOUNT BASIN

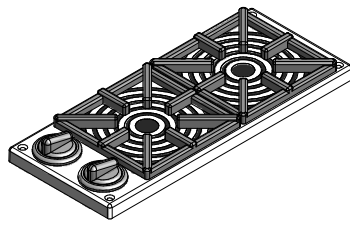

(1) STOVE KIT - A6P00025

STEP 22:

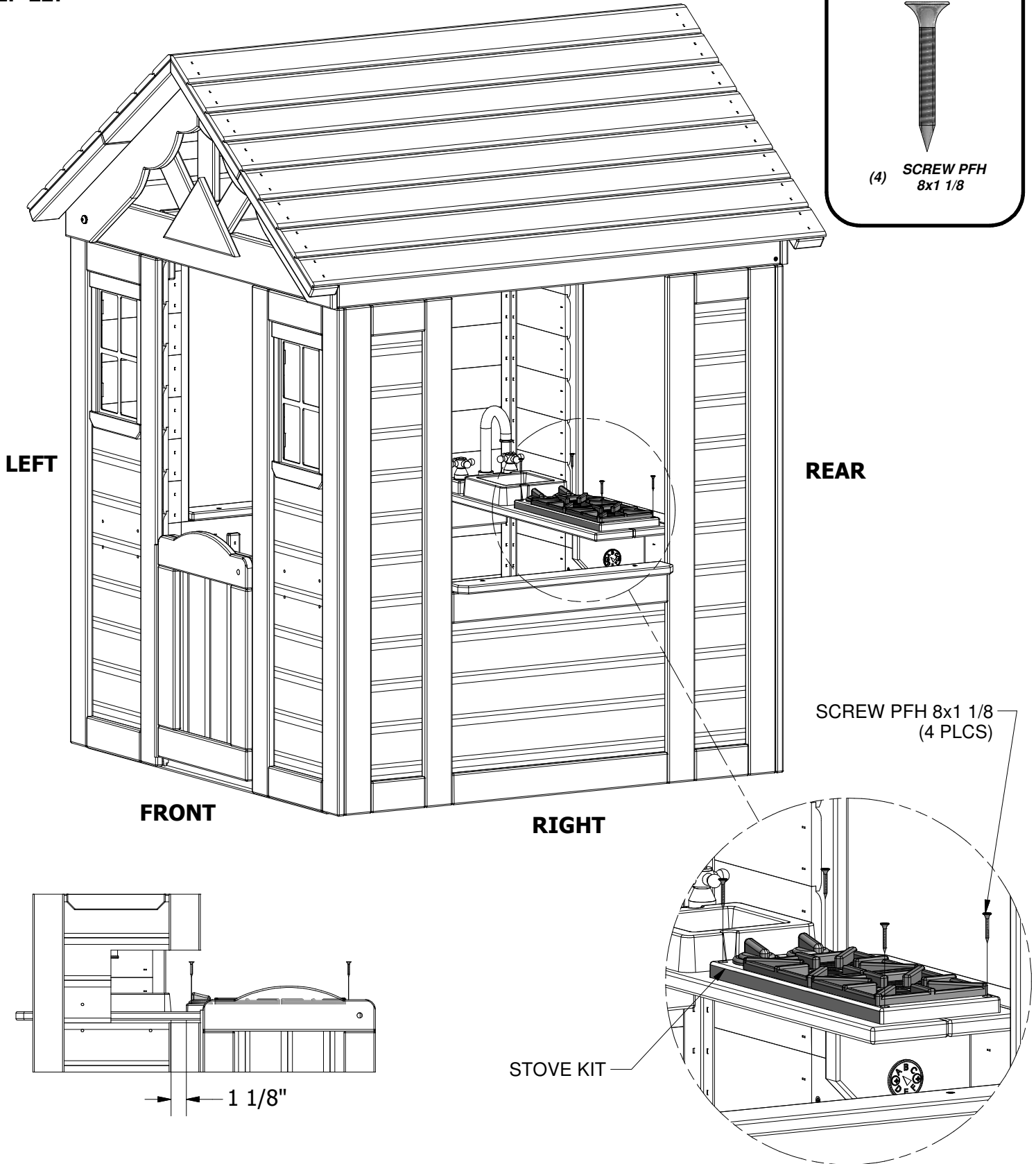

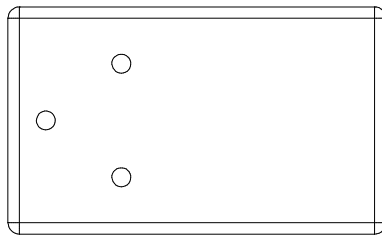

(1) **N3 - DOOR STOP - W4L04761**
5/8"x2 3/8"x3 7/8" (16x60x100)

STEP 23:

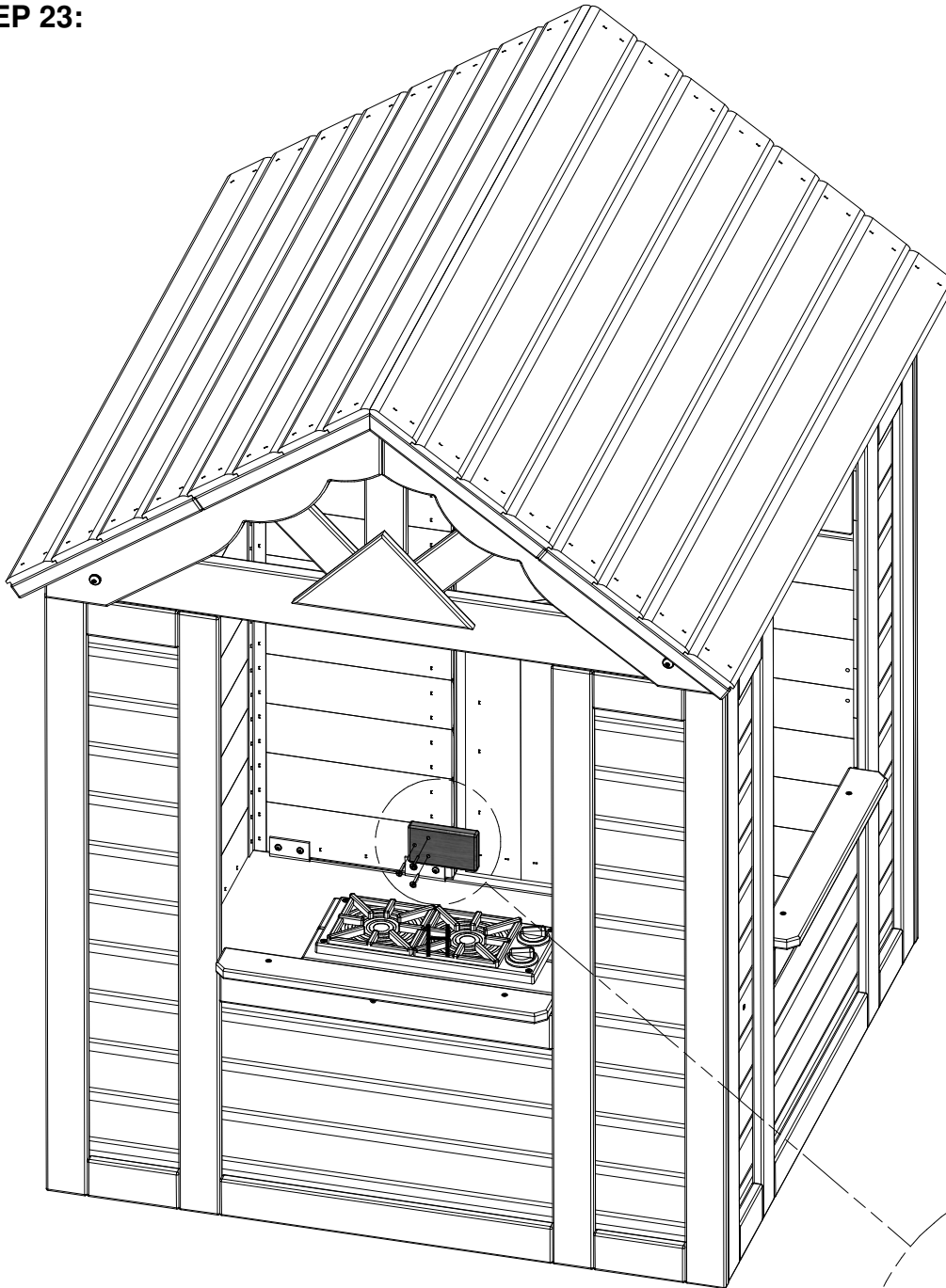
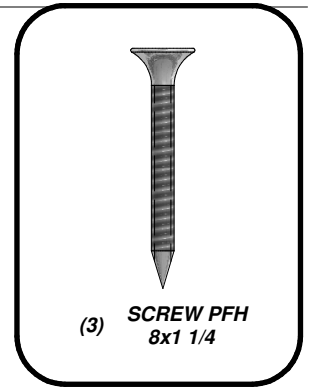

SCREW PFH 8x1 1/4
(3 PLCS)

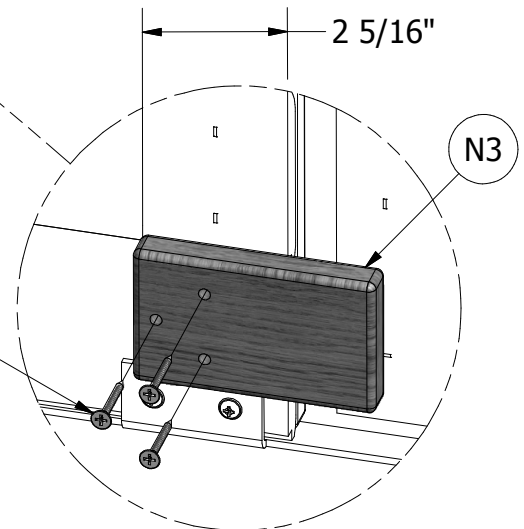

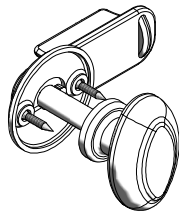

(1) KNOB KIT - A6P00020

STEP 24:

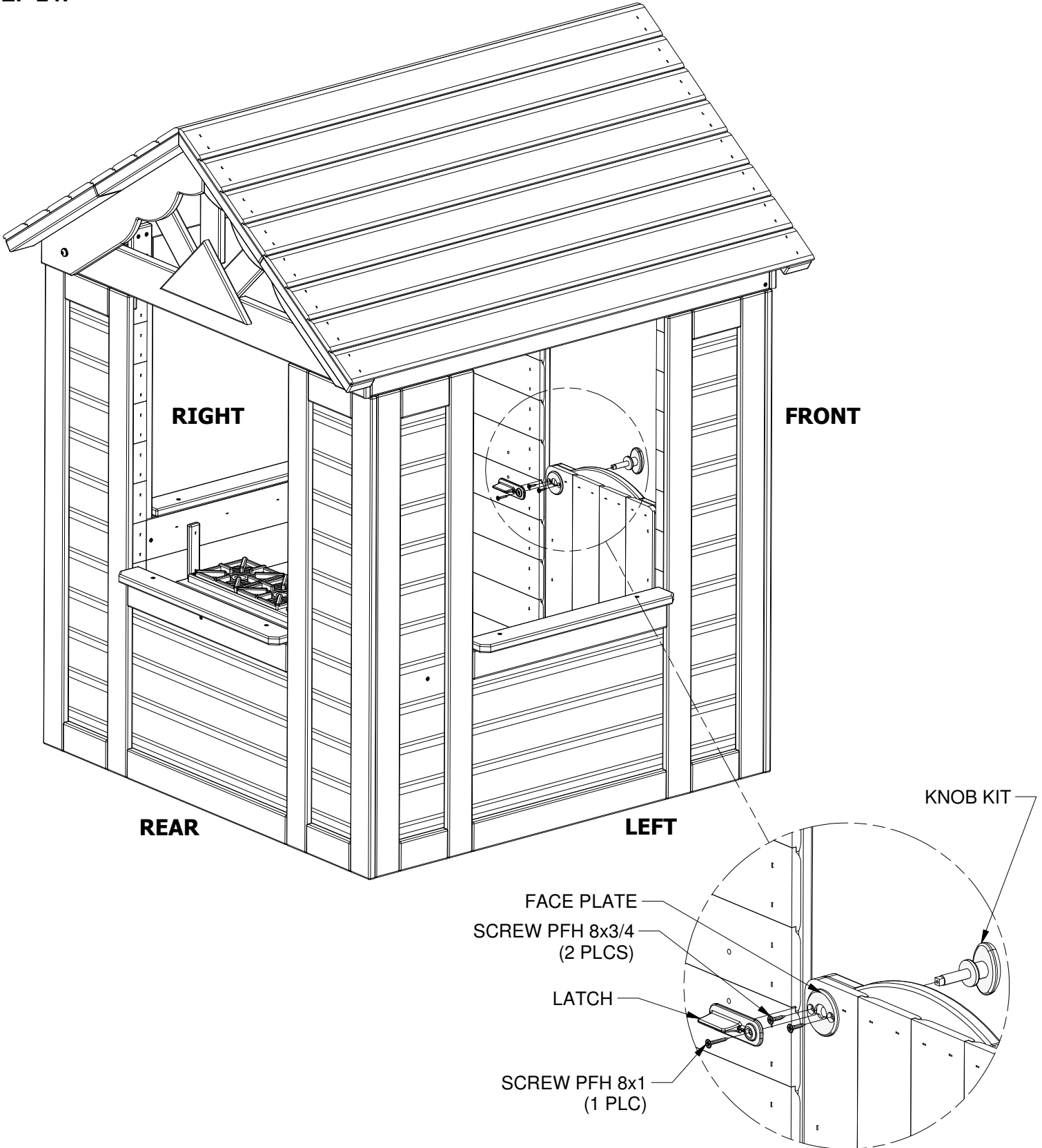



(1) PHONE KIT - A100132

STEP 25:

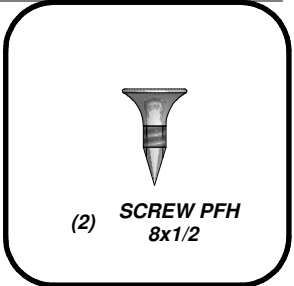

(2) SCREW PFH
8x1/2

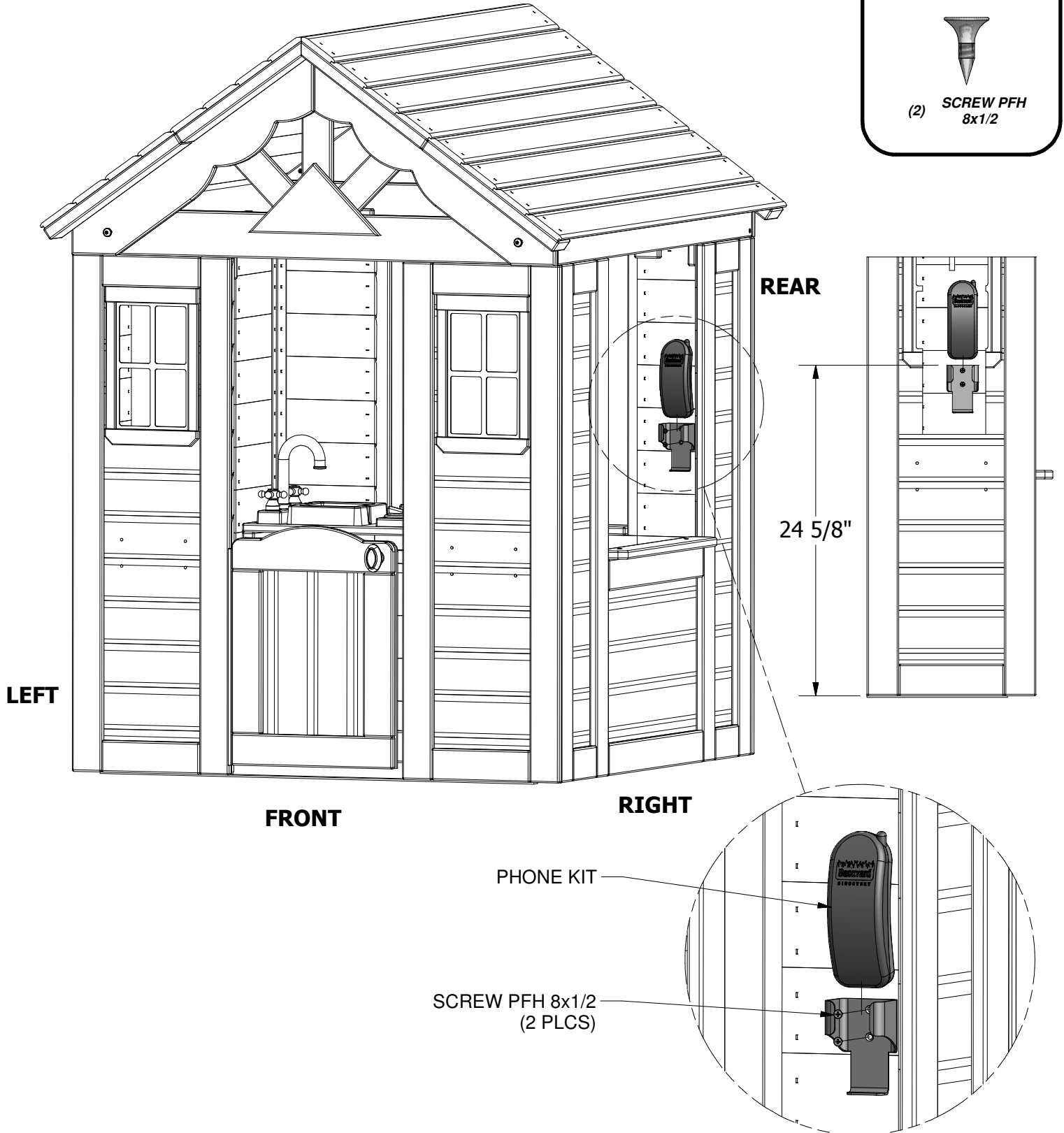

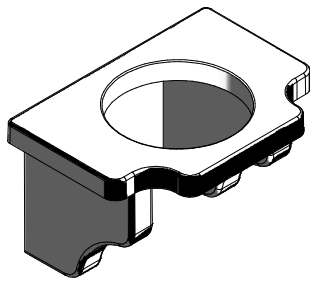

(2) FLOWER POT HOLDER - A6P00023

STEP 26:

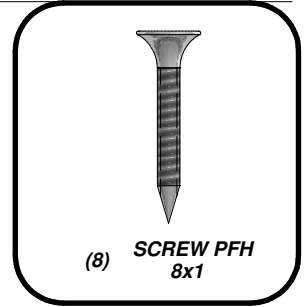

(8) SCREW PFH
8x1

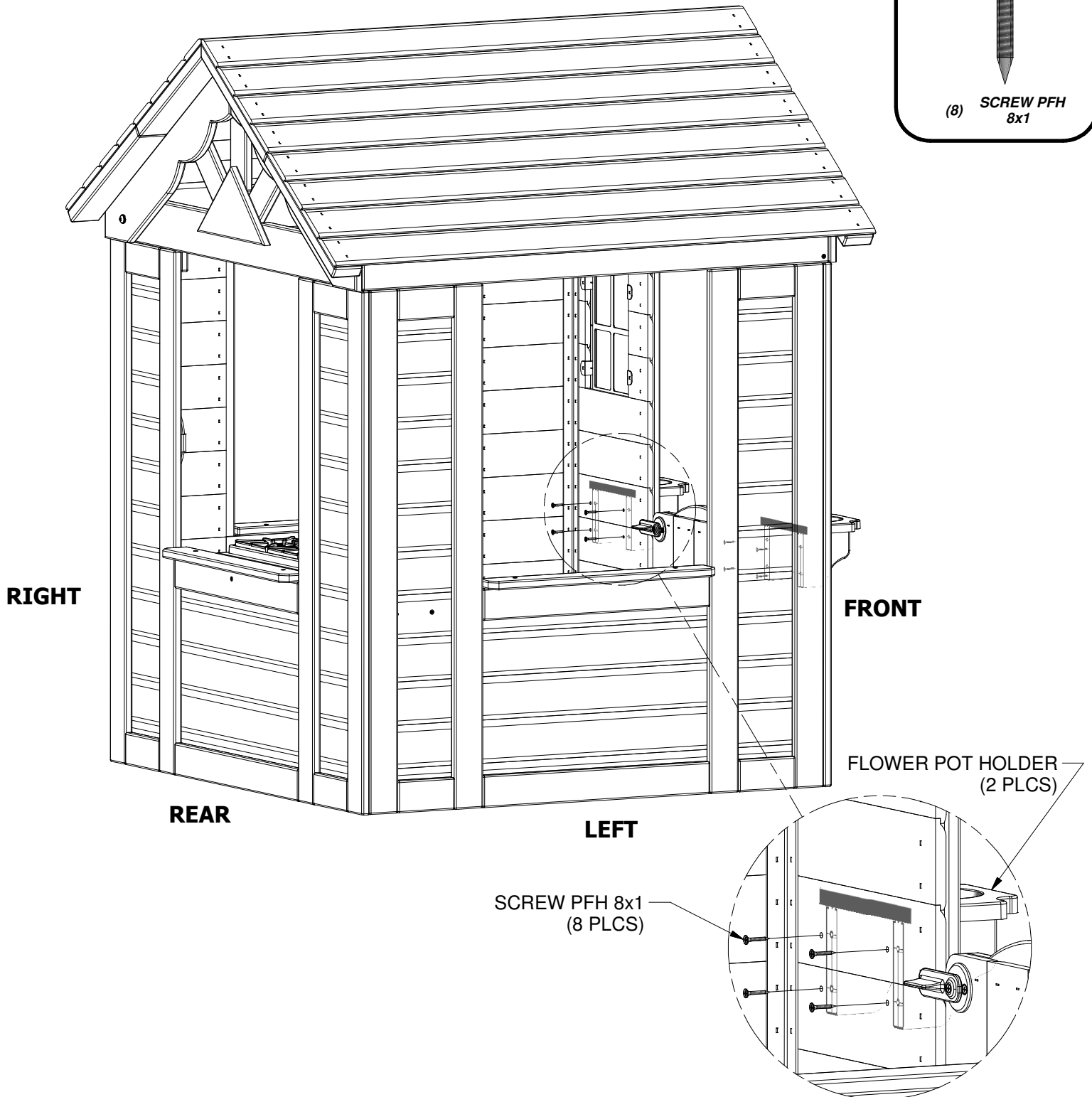

RIGHT

FRONT

REAR

LEFT

FLOWER POT HOLDER
(2 PLCS)

SCREW PFH 8x1
(8 PLCS)



(1) **BYD ID TAG (MEDIUM) AGES 2 TO 10 - A4M00528**

STEP 27:

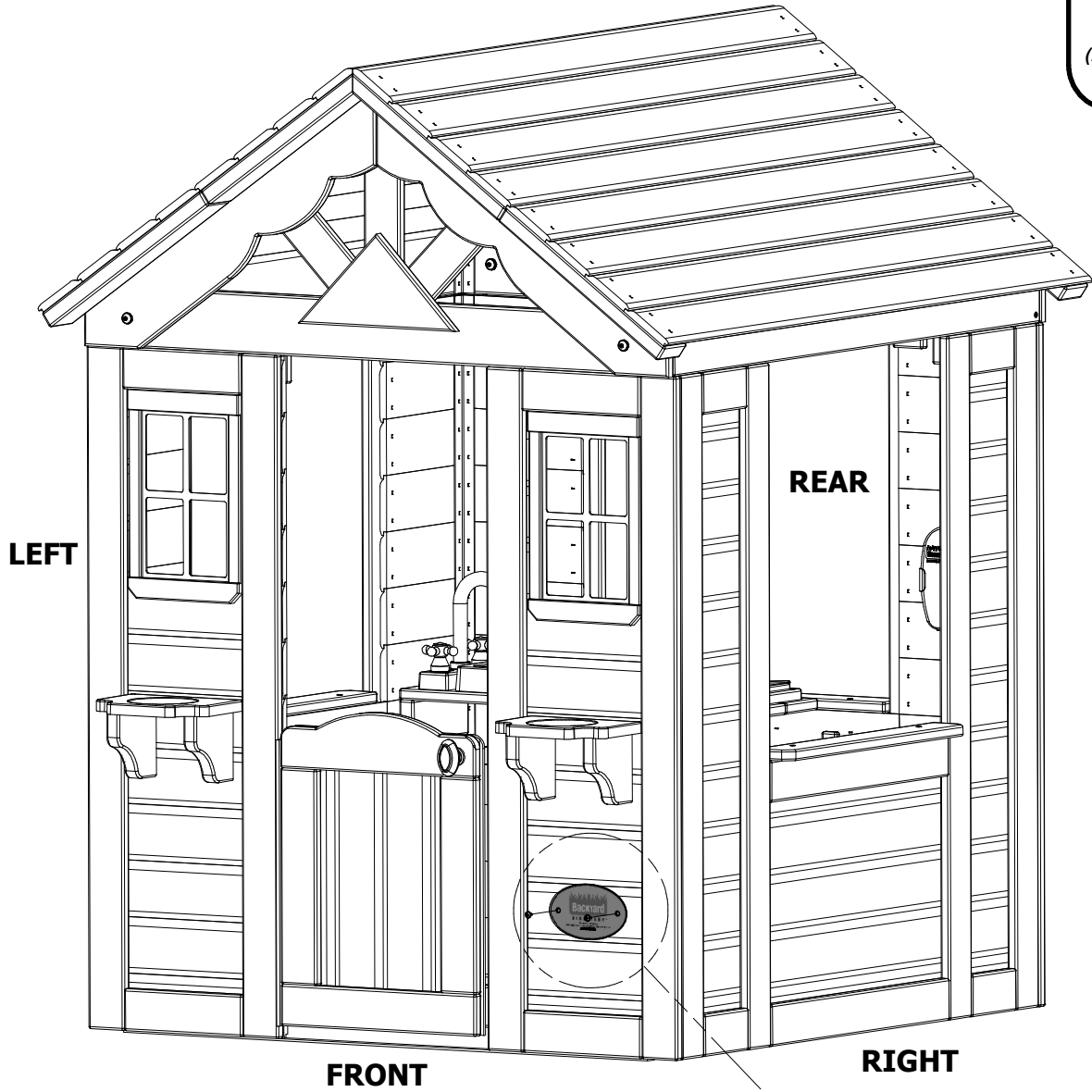

SCREW PWH 8x7/16
(2 PLCS)

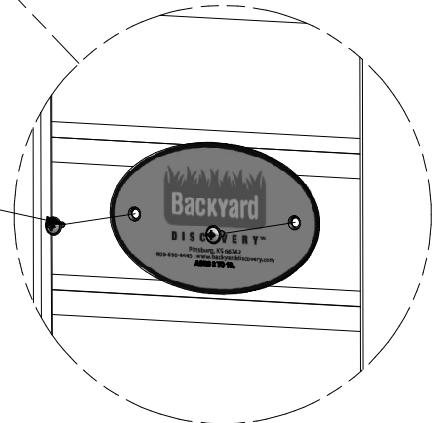

Limited Warranty

This Limited Warranty by Backyard Discovery applies to products manufactured under the Backyard Discovery brand or its other brands including but not limited to Backyard Botanical, Adventure Playsets, and Leisure Time Products.

Backyard Discovery warrants that this product is free from defect in materials and workmanship for a period of one (1) year from the original date of purchase. This one (1) year warranty covers all parts including wood, hardware, and accessories. All wood carries a five (5) year pro-rated warranty against rot and decay. Refer to the schedule below for charges associated with replacement of parts under this Limited Warranty. In addition, Backyard Discovery will replace any parts within the first 30 days from date of purchase found to be missing from or damaged in the original packaging.

*This warranty applies to the original owner and registrant and is **non-transferable**. Regular maintenance is required to assure maximum life and performance of this product and failure by the owner to maintain the product according to the maintenance requirements may void this warranty. Maintenance guidelines are provided in the Owner's Manual.*

This Limited Warranty does not cover:

- *Labor for any inspection*
- *Labor for replacement of any defective item(s)*
- *Incidental or consequential damages*
- *Cosmetic defects which do not affect performance or integrity of a part or the entire product*
- *Vandalism, improper use, failure due to loading or use beyond the capacities stated in the applicable Assembly Manual.*
- *Acts of nature including but not limited to wind, storms, hail, floods, excessive water exposure*
- *Improper installation including but not limited to installation on uneven, unlevel, or soft ground*
- *Minor twisting, warping, checking, or any other natural occurring properties of wood that do not affect performance or integrity*

Backyard Discovery products have been designed for safety and quality. Any modifications made to the original product could damage the structural integrity of the unit leading to failure and possible injury. Modification voids any and all warranties and Backyard Discovery assumes no liability for any modified products or consequences resulting from failure of a modified product.

This product is warranted for RESIDENTIAL USE ONLY. Under no circumstance should a Backyard Discovery product be used in public settings. Such use may lead to product failure and potential injury. Any and all public use will void this

warranty. Backyard Discovery disclaims all other representations and warranties of any kind, express or implied.

This Warranty gives you specific legal rights. You may have other rights as well which vary from state to state or province to province. This warranty excludes all consequential damages, however, some states do not allow the limitation or exclusion of consequential damages and therefore this limitation may not apply to you.

Pro Rated Part Replacement Schedule

Product Age

Customer Pays

All Parts

0-30 days from date of purchase

\$0 and free shipping

31 days to 1 year

\$0 + S&H

Wood Rot and Decay Only

1 year

\$0 and free shipping

2 years

20% + S&H

3 years

40% + S&H

4 years

60% + S&H

5 years

80% + S&H

Over 5 years

100% + S&H