

BigRoof



For after sales support and customer service,
visit us at www.bigroofus.com

INTRODUCTION

Thanks for purchasing and trusting Bigroof with your home decorating plans. This product is a furniture designed and made by Bigroof Company. We are committed to R&D innovation and to create the most refined, diverse choice of outdoor collection. After unpacking and before every use, check whether the item shows any damages. In addition, check that you have all parts and hardwares before assembly. If there is any damage, please do not use and just send an email to support@bigroofus.com. If you do not have all the parts lists, have your dealer contact us and they will be sent to you immediately. This furniture is intended for indoor and outdoor use. Please take time to read and follow the instruction below. Use the item as described in this operating manual. We accept no liability for damages caused by improper use.



ASSEMBLY INSTRUCTIONS



















Step1: Attach left & right armrest (A,B) to seat frame(C) using 1 washer, 1 bolt(K). Do not over tighten.

Step2: Attach left & right armrest (A,B) to back frame (D) using 4 washers(I), 4 bolts(K). Do not over tighten.

Step3: Attach legs under high chair (E,F) to fixed ring (G) using 4 washers(I), 4 bolts(M), 4 nuts(L). Do not over tighten.

Step4: Attach legs under high chair (E,F) to seat frame(C) using 4 washers(I), 4 bolts(O), 4 nuts(L). Do not over tighten.

Step5: Upon completion of full assembly and bolted up-all screws can be tightened down. Button the nut cap(J) or (N).

 Right Armrest	A 2PCS	 Left Armrest	B 2PCS	 Seat	C 2PCS	 Back	D 2PCS	 Up Leg	E 2PCS
 Low Leg	F 2PCS	 Chair Fixed Frame	G 2PCS	 Bolt (M6x25mm)	H 8PCS	 Washer	I 72PCS	 Bolt Cap	J 24PCS
 Bolt (M6 x 30mm)	K 16PCS	 Nut	L 24PCS	 Bolt (M6x55mm)	M 8PCS	 Nut Cap	N 8PCS	 Bolt (M6x35mm)	O 8PCS
 Driver	U 1PC	 Wrench	V 1PC	 Screwdriver	W 2PCS				

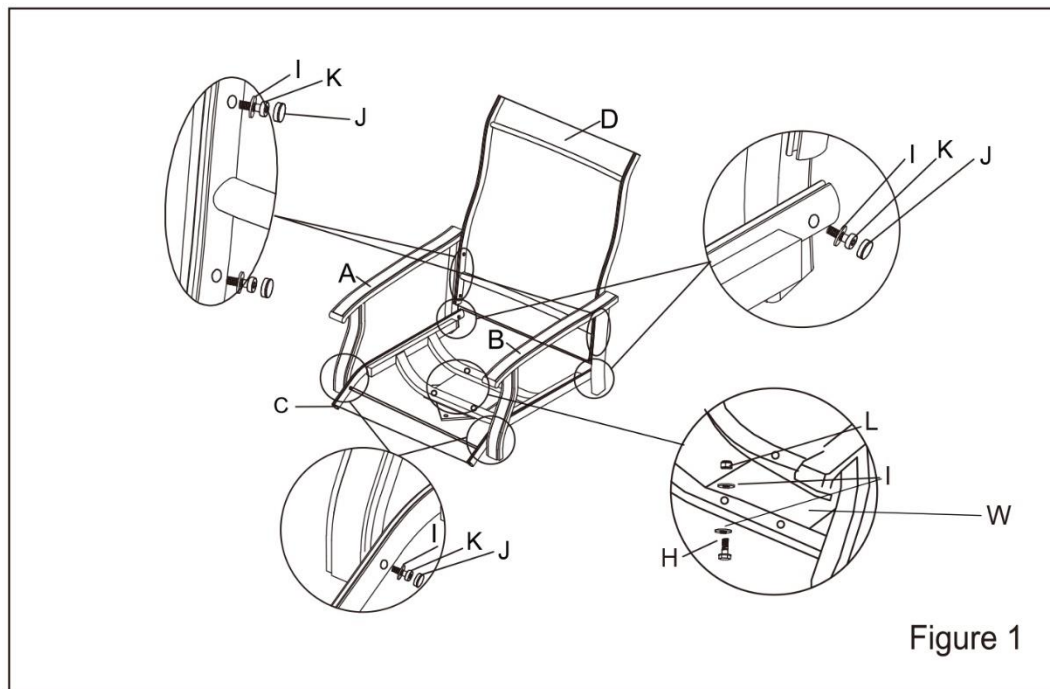

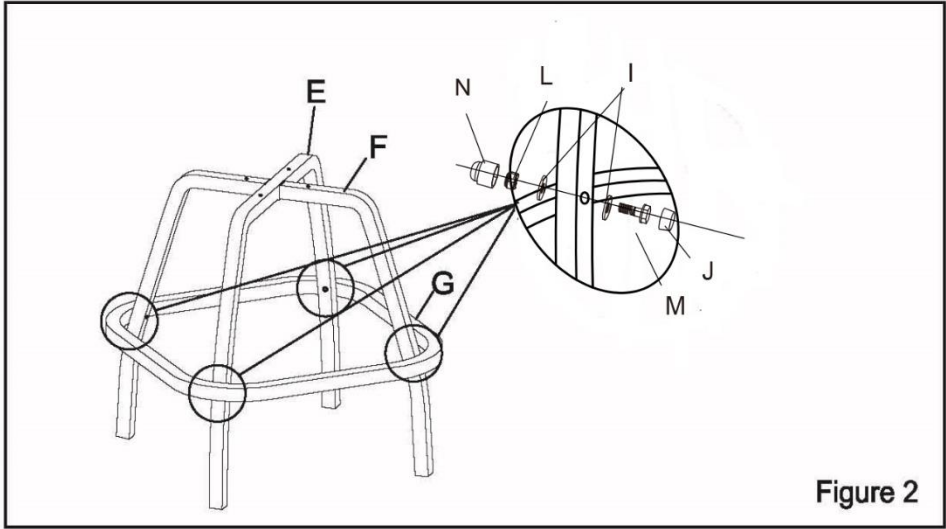

Figure 2

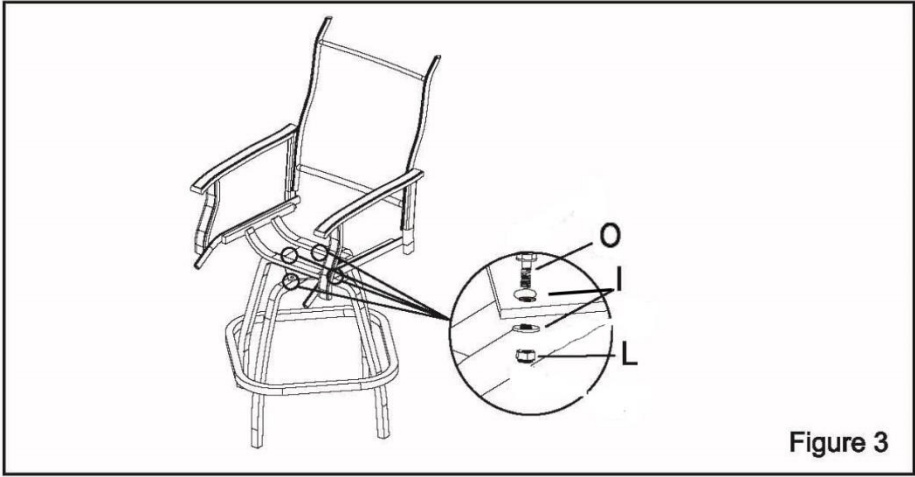

Figure 3

CARE AND MAINTENANCE

Follow the instruction for the material of your special product to make sure that it stays in the best shape for as long as possible. The information below is only intended as a general guideline. For more information, please contact us. ·

--Only need to rinse it thoroughly with clean water to wash away dirt and grime. Never use abrasive cleansers on the furniture since it can attack the surfaces and leave behind scratch marks. ·

--For the stubborn grime and stains, just use a soft sponge and mild soapy water and then dry it with a cloth or paper towel. ·

--Check the stability of the screws, nuts, and nut caps prior to each use. Tighten up them after one to two months use whenever required. ·

--Avoid improper use and be careful not to scratch or damage the surface with sharp objects. ·

--When you move your furniture, make sure you lift it rather than pulling or pushing it to avoid damaging the floor, legs and mounting.

Visit us at:

www.bigroofus.com

Contact us:

support@bigroofus.com

-----ENJOY LIFE · SHARE HAPPINESS-----

©2021, Bigroof. All rights reserved