

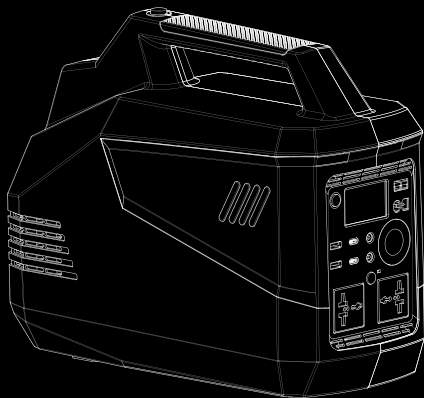

## Portable Power Station



Model: L780  
Part No.: PR750NAL780

# USER MANUAL

If in need of service, please contact aviva Customer Service. Do not return this unit to the store.

## **aviva Customer Service**

Email: [support@avivapower.com](mailto:support@avivapower.com)

Visit: [www.avivapower.com](http://www.avivapower.com)

**Thank you for purchasing the aviva L780 portable power station.** The purpose of this manual is to help you understand your product and its use. You can use this product at home and away, wherever life takes you. Many people will use the aviva L780 as a central power source at home, or wherever they need portable power such as off-grid, or for emergency back-up power. **Save this User Manual.**

**Long-Term Maintenance:**

Fully charge the power station unit prior to long-term storage. Check and charge the power station unit at least once every three months.



**WARNING**

Keep away from water and fire  
Only authorized personnel may service this product

- Specifications
- Product tour & functions
- General information
- How to charge the product
- Lighting
- Recharging
- Warning states
- Disposal
- Troubleshooting
- Attention
- Safety and maintenance
- Warranty statement

## SPECIFICATIONS

Model Number	L780
Part Number	PR750NAL780
<b>Battery</b>	
Energy Storage Capacity	786 Wh (10.8V, 72.8 Ah), peak capacity Lithium-Ion, 18650-cell type, 2600mAh @ 3.6V
Equivalent Capacity	218Ah, 218,400mAh @ 3.6V
Lifecycles	≥1000 cycles up to 80% with full charge/discharge
Shelf-life	Up to 6 months after full charge; re-charge once every 3-6 Months
Wattage Compatibility	500 W continuous
Battery Management System (BMS)	Over voltage protection, low-voltage protection, over temperature protection, short circuit protection, over current protection
<b>Input Ports</b>	
DC Charging	2-pin AC adaptor
Solar Port	Anderson port (PA45); 14V - 25V / maximum power up to 180W
<b>Output Ports</b>	
USB-C	Two (2) USB-C PD output ports, 65W supports 5V, 9V, 12V, 15V, 20V up to 3A, regulated
USB-A	Two (2) USB-A ports (output): 5V, 9V, 12V up to 2.4A regulated (18W max), Qualcomm QuickCharge 3.0

DC Port (5525)	Two (2) 12V 5A / 60W (2@ DC5525 ports)
12V Auto Port	12.5V 10A / 125W, regulated
110V AC inverter	Two (2) 110VAC, 60Hz, grounded (3-prong), pure sine wave Supports 500W continuous, 2500W peak surge, pure sine wave
<b>General</b>	
Flashlight	High brightness 1W LED, multimode, with SOS mode
Display Panel	LED display - info relates watt input/ output, battery status
Color	Two tone, gray + black
Cabinet	Durable ABS polycarbonate shell
Unit Weight	16.5 lbs (7.5 kgs)
Unit Dimensions	13.7 × 6.3 × 11.2 in (35 × 16 × 29 cm)
Retail Box Weight	20 lbs (9.06 kgs)
Operating Use Temperature	14 ~ 113 F (-10 ~ 45 C)
Recharging Temperature	32 to 113 F (0 ~ 45 C)
AC Charger (Included)	110V / 60Hz; 13V, 250VA, includes power cord
Certifications	FCC, PSE, RoHS, UN38.3
Warranty	1 Year

<b>How to recharge:</b>	Approximate recharge times:
AC Wall Outlet	10 hrs
12V Auto Port	10 hrs (with engine on)
Solar Panel, 100 W	17 hrs
<b>Optional Accessories</b>	Portable solar panel
<b>Included in the Box</b>	Power station, AC charger with power cable, user manual

## Included in the Box:

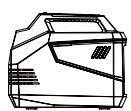

Aviva L780 unit

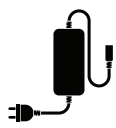



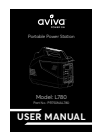







Charger



User Manual

## Loading Time:

 12V 3W Lighting	 Stereo	 PSP	 Camera	 Smart Phone	 Tablet	 Laptop	 60W Fan	 32" TV	 Mini Bar
230h+	500X+	90X+	160X+	70X+	17X+	8X+	12h+	7h+	15h+

### Front View

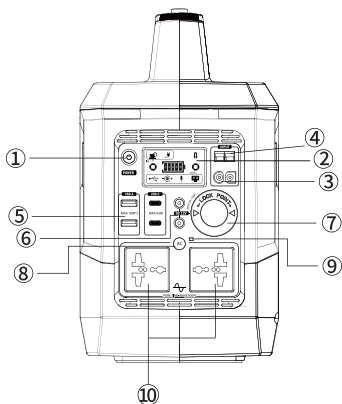

1. ON/OFF Power Switch
2. LCD Screen
3. AC Adapter Input
4. Solar Charging Input
5. USB Outputs
6. 12V DC Outputs
7. DC Auto Output
8. AC Output Button
9. AC Output Indicator
10. AC Outputs

### Left View

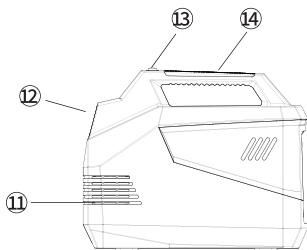

11. Cooling Fan
12. Light
13. Light Button
14. Handle



## LCD Screen Guide

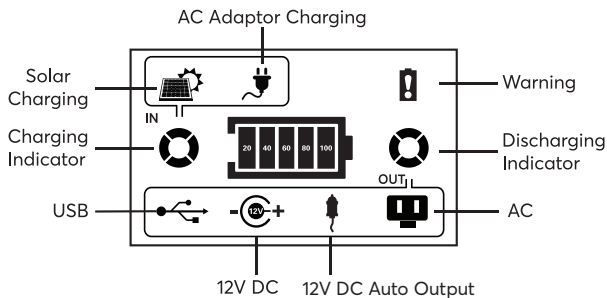

### Battery

 Battery Level Indicator

### Output

 USB in use

 12V DC in use

 12V DC Auto Output in use

 AC Power is on

 Remain rotating when DC in use or AC is on

### Input

 In Solar Charging

 In AC Charging

 In the Charging Process

### Using the aviva L780

When battery capacity is below 5%, all the outputs (including AC, USB-A, Type-C, DC 12V, and DC Auto Output) will be automatically disabled.

When DC is in use or AC is on, the discharging indicator on the right side of LCD screen remains rotating (  ).

### Power On

Long press for 3 seconds to switch on the aviva L780, it will start initial self-checking. During the process, all the icons on the LCD screen will be activated. The LCD screen will turn to normal display if all functions are normal.

### Power Off

When usage is complete, power off the unit by following these steps:

- 1) Remove all the connected cables and loads;
- 2) Press to turn off the AC output, and the LED indicator will be off;
- 3) Long press the AC button to turn off power. The LED indicator light will then power off;
- 4) Low battery automatic shutdown.

### Using AC Output

Press AC output button, LED indicator is on and the AC output icon (  ) on the LCD screen will be activated, then you can charge your devices. When you finish using, press AC output button to turn off the AC output. The interval time between pressing AC output button on/off should not be less than 5 seconds.

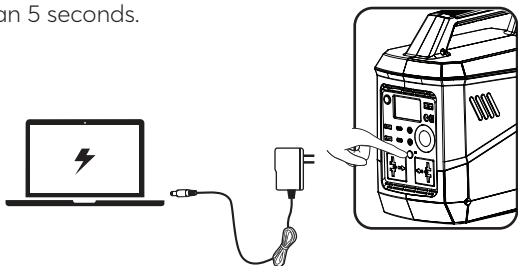

### Using 5V Output

USB outputs can be used directly to charge your devices. When the aviva L780 detects the load, the USB icon (  ) on the LCD screen will be activated.

The aviva L780 has both USB-A and Type-C ports, that can recharge a variety of devices. Please see the technical specification for output parameters in Page 8. Note different USB ports are not allowed to connect/modify in parallel for use.

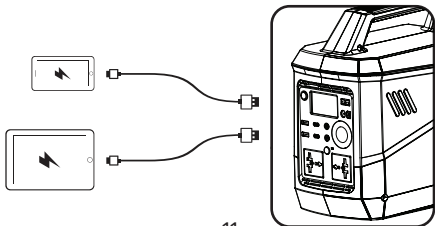

## Using 12V DC Output

12V DC outputs can be used directly to charge your devices. When the aviva L780 detects the load, the DC icon (  ) on the LCD screen will be activated.

Our product has two separate 12V DC outputs, with the same output power.

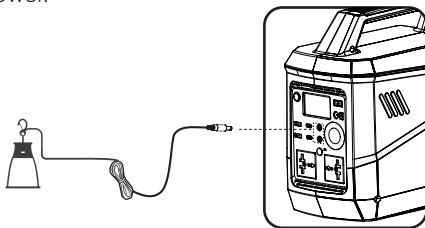

## Using 12V DC Auto Output

12V DC Auto Output can be used directly to charge your devices. When the aviva L780 detects the load, the 12V DC Auto Output icon (  ) on the LCD screen will be activated. The maximum output power is 120W.

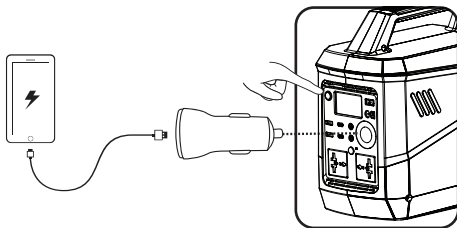

## LIGHTING

The aviva L780 has 5 lighting modes:

High bright (100% power), Normal (50% power), Energy saving (25% power), Emergency flash and SOS.

Press the light button firmly to turn on/off the light, and press gently to shift between different modes.

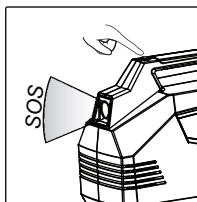
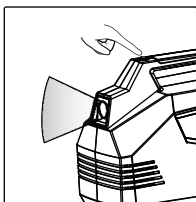

## HOW TO RECHARGE

### Wall Charging

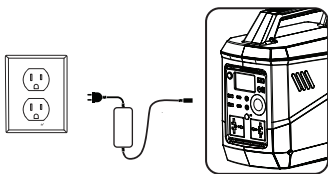

### Solar Charging

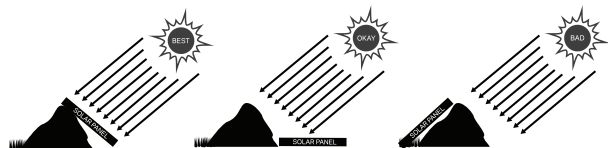
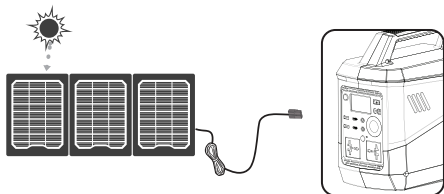











The solar panels generate electricity instead of storing it, even in overcast conditions. Keeping solar panels toward the sun at a proper angle can significantly improve efficiency.







Following full re-charge times are based on ideal conditions:

	40W Input	60W Input	80W Input	100W Input	120W Input
aviva L780	33hrs-42hrs	20hrs-25hrs	17hrs-20hrs	13hrs-17hrs	10hrs-12hrs

The above data is for reference only. The data will fluctuate depending on the environment, use method and other factors.

## WARNING STATES

Item	Buzzer	Icon Display		Causes	
1	One buzzing sound every 3 seconds and buzzing stops after 30 seconds.		Battery icon flashes	Flashes continuously when battery capacity $\leq 5\%$	
2				Battery and AC output icons flash	AC output is locked when battery capacity $\leq 5\%$
3				Battery and DC auto output icons flash	Use DC auto output when battery capacity $\leq 5\%$
4				Battery and 12V DC icons flash	Use 12V DC output when battery capacity $\leq 5\%$
5				Battery and USB icons flash	Use USB output when battery capacity $\leq 5\%$
6	Three buzzing sounds every 3 seconds and buzzing stops after 30 seconds.			Warning and solar input icons flash	AC charging failure caused by one of any following reasons: 1) Charging voltage is out of allowable range; 2) Charging current is beyond the max. allowable value; 3) Solar charging port is over-temperature.
7				Warning and charger icons flash	Charging failure caused by one of any following reasons: 1) Charging voltage is out of allowable range; 2) Charging current is beyond the max. allowable value; 3) AC charging port is over-temperature.
8				Warning and AC icons flash	AC output failure caused by one of any following reasons: 1) Overload; 2) Short-circuit; 3) Inverter is protected due to over-temperature; 4) Communication between inverter and display board is interrupted.

9	Three buzzing sounds every 3 seconds and buzzing stops after 30 seconds.			Warning and DC auto output icons flash	DC auto output failure caused by one of any following reasons: 1) Overload; 2) Short-circuit
10				Warning and 12V DC icons flash	12V DC output failure caused by one of any following reasons: 1) Overload; 2) Short-circuit; 3) Reverse charge through the DC auto output
11				Warning and USB icons flash	USB output failure caused by one of any following reasons: 1) Overload; 2) Short-circuit; 3) Over-voltage.
12				Warning and Battery icons flash (power icon normally displays)	Communication between battery voltage acquisition board and display board is interrupted.
13				Warning, Battery and Power icons flash (power icon displays current power)	Battery alarm due to over-temperature protection or low-temperature protection.

## DISPOSAL

The aviva L780 must not be disposed as household waste. To improve the environmental management of WEEE and to contribute to a circular economy, useful raw materials can be recycled and reused to protect the environment. Please dispose batteries according to local regulations.



## TROUBLESHOOTING

No.	Faults	Causes	Solutions
1	Power-up Failure	Under-voltage Protection	Charge the aviva L780.
		Abnormal Load Protection	Remove the loads and recharge the aviva L780. If the problem can not be solved, ask for customer service.
		Product Failure	Contact aviva Customer Service.
2	Charger Fault	Unmatched Charger	Only use the authorized charger.
		Charger Failure	Contact aviva Customer Service.
		Abnormal Power Supply or Connection	Re-connect the charger. If the problem cannot be solved, contact aviva Customer Service.
3	Solar Panel Charging Fault	Over-voltage	Use the recommended solar panel.
		Weak Sunlight	Charge in location with more direct sunlight.
		Solar Panel Failure	Contact aviva Customer Service.
		Abnormal Wiring-harness Connection	Re-connect the wiring-harness. If the problem can not be solved, contact your local dealer to replace the solar panel.
4	DC / AC Output Fault	Battery Under-voltage Protection	Charge the aviva L780.
		Discharge Over-current Protection	Check and ensure the power loads are within the allowed range.
		Over-temperature Protection	Turn off the aviva L780 and restart after cooling down.
		Product Failure	Contact aviva Customer Service.
5	Abnormal Icon Display	Abnormal Loads	Remove the loads.
		Hardware Fault	Contact aviva Customer Service.
		LCD Screen Failure	Contact aviva Customer Service.
6	LCD Screen Fault	LCD Screen Failure	Contact aviva Customer Service.

## ATTENTION



The aviva L780 may be used to charge your devices within the temperature range of -10C to 45C. Do not use in environments outside of the recommended temperature range.



Recharge the aviva L780 only within the temperature range of 0 C-45 C. Recharging the aviva L780 above 45 C may cause overheating or fire.



Do not recharge the aviva L780 more than 12 hours, overcharging may shorten the service life or cause danger.



Use the original or authorized cable or charger.



Use the aviva L780 between 20%-90% battery level to achieve longer service life and better performance.



Keep away from heat source, fire, inflammable gas or liquid, and do not expose to the sun for long time.



Recharge or use it at least once every four months for a longer service life.



Keep away from children or pets.



Not allowed aboard planes.



Unauthorized disassembly is forbidden. Violation may cause electric shock or product damage, even fire or explosion in serious situations. Exposure to internal components may result in electric shock, fire, explosion or product damage.



Avoid dropping the aviva L780.



Avoid coming in contact with magnetic materials.

## SAFETY AND MAINTENANCE

1. This product may become warm to hot during charging, this is normal. Be careful when handling.
2. Avoid storing this device nearby coins, jewellery, keys, and other metal objects. Exposure to metals has a negative effect on the battery and may cause damage.
3. Do not place the unit near or under intense heat or fire.
4. The unit is not waterproof, avoid water and other liquids.
5. Store the unit in a cool, dry place and avoid humid, dusty environments.
6. Do not disassemble this device without permission.
7. Do not drop, nor place heavy objects on or strike the product with force.
8. Do not cover this product with objects, such as towels or clothing during use.
9. Do not charge longer than the time required to charge this product.
10. Unplug devices from the aviva L780 once fully charged.

aviva Power warrants to the original consumer purchaser that the aviva product will be free from defects in workmanship and material under normal consumer use during the applicable warranty period identified in the 'Warranty Period' section below, subject to the exclusions set forth below. This warranty statement sets forth aviva's total and exclusive warranty obligation. We will not assume, nor authorize any person to assume for us, any other liability in connection with the sale of our products.

### **Warranty Period:**

The warranty period is 12 months. In each case, the warranty period is measured starting on the date of purchase by the original consumer purchaser. The sales receipt from the first consumer purchase, or other reasonable documentary proof, is required in order to establish the start date of the warranty period.

### **Remedy:**

aviva Power will repair or replace (at aviva's option) any aviva product that fails to operate during the applicable warranty period due to defect in workmanship or material. If a valid claim is made during the applicable period, aviva, at its option, will either (1) replace the product, or (2) exchange the product with a product that is of equal value. A replacement product assumes the remaining warranty of the original product or 60 days from the date of replacement, whichever is greater. Customer is responsible for the return shipping costs.

### **Limited to Original Consumer Buyer:**

The warranty on aviva's product is limited to the original consumer purchaser.

**Exclusions:**

aviva's warranty does not apply to (I) any product that is misused, abused, modified, damaged by accident, or used for anything other than normal consumer use as authorized in aviva's current product literature, or (II) any product purchased through an online auction house. aviva's warranty does not apply to the battery cell unless the battery cell is fully charged by you within seven days after you purchase the product and at least every 6 months thereafter.

**How to Receive Service:**

To obtain warranty service, you must contact our customer service team via email at [support@avivapower.com](mailto:support@avivapower.com). If our customer service team determines that further assistance is required, they will give you a Return Material Authorization ("RMA") number and will provide you with return instructions. You must properly package the product, clearly marking the RMA number on the package and including proof of your purchase date with the product. We will process your return and send your repaired or replacement product to you in North America. For product purchased or being shipped outside of North America, please contact the local distributor from whom you purchased the product or email [support@avivapower.com](mailto:support@avivapower.com) to obtain further information.

**Exclusive Remedy; Limitation of Liability:**

The foregoing provisions state aviva's entire liability, and your exclusive remedy, for any breach of warranty, express or implied. IN NO EVENT WILL AVIVA BE LIABLE FOR ANY CONSEQUENTIAL OR INCIDENTAL DAMAGES ARISING FROM ANY USE OR MALFUNCTION OF ANY AVIVA PRODUCT, OR FROM ANY BREACH OF WARRANTY, INCLUDING DAMAGE TO OTHER DEVICES. IN NO EVENT WILL AVIVA'S LIABILITY FOR ANY CLAIM, WHETHER IN

CONTRACT, WARRANTY, TORT (INCLUDING NEGLIGENCE AND STRICT LIABILITY) OR UNDER ANY OTHER THEORY OF LIABILITY, EXCEED THE AMOUNT PAID BY YOU FOR THE AVIVA PRODUCT. Some states or provinces do not allow the exclusion or limitation of incidental or consequential damages, so the above limitation or exclusion may not apply to you.

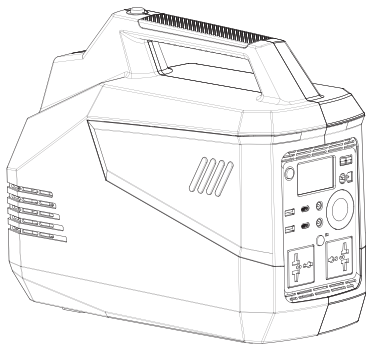

© 2020 All Rights Reserved. GoodWorks Global LLC. All trademarks cited herein are the property of their respective owners. The information contained herein is subject to change without notice. The only warranties for aviva products and services are set forth in the warranty statements accompanying such products and services. aviva shall not be liable for technical or editorial errors or omissions contained herein.

### **IMPORTANT NOTICE:**

1. The pictures in this manual are for reference only. If some pictures do not match the actual product, the actual product shall prevail.
2. The AC power socket and AC voltage and frequency of this product vary from country to country, please refer to the actual product.

**First Edition: 120120.**

**Document Part Number: L780UMV1.**



[www.avivapower.com](http://www.avivapower.com)