



STANDING PATIO HEATER

ITEM: 96053 Bronze, 96054 Mocha



OWNER'S MANUAL AND SAFETY INSTRUCTIONS

SAVE THIS MANUAL: KEEP THIS MANUAL FOR SAFETY WARNINGS, PRECAUTIONS, ASSEMBLY, OPERATING, INSPECTION, MAINTENANCE AND CLEANING PROCEDURES. WRITE THE PRODUCT'S SERIAL NUMBER ON THE BACK OF THE MANUAL NEAR THE ASSEMBLY DIAGRAM (OR MONTH AND YEAR OF PURCHASE IF PRODUCT HAS NO NUMBER)

FOR QUESTIONS PLEASE CALL OUR CUSTOMER SUPPORT: 909.628.0880 MON-FRI 9AM TO 3PM PST



GENERAL SAFETY WARNINGS

Read all safety warnings and instructions. Failure to follow the warnings and instructions may result in fire and/or serious injury. Save all warnings and instructions for future reference.

SAFETY

The warnings, precautions, and instructions discussed in this instruction manual cannot cover all possible conditions and situations that may occur. It must be understood by the operator that common sense and caution are factors which cannot be built into this product, but must be supplied by the operator. Read carefully and understand all **ASSEMBLY AND OPERATION INSTRUCTIONS** before operating. Failure to follow the safety rules and other basic safety precautions may result in serious personal injury.

- Keep solid combustibles, such as building materials, paper or cardboard a safe distance away from the heater as possible. See further instructions.
- Provide adequate clearances around air openings into the combustion chamber.
- **NEVER** use the heater in spaces that contain volatile or airborne combustibles or products such as gasoline, solvents, paint thinner, dust particles or unknown chemicals.
- During operation, this product can be a source of ignition. Keep the heater area clear and free from combustible materials, gasoline, solvents, paint thinner, cleaning solvents and other flammable vapors and liquids.
- Minimum heater clearances from combustibles is three feet from the sides and two feet from the top of the heater.
- **NEVER** store propane near high heat, open flames, pilot lights, direct sunlight, other ignition sources or where temperatures exceed 120 degrees F.
- Propane vapors are heavier than air and can accumulate in low places. If you smell gas, leave the area immediately.
- **NEVER** install or remove propane cylinder while the heater is lit, near flame, pilot lights, other ignition sources or while the heater is hot to the touch.
- Store the propane cylinder outdoors in a well ventilated space out of reach of children. **NEVER** store the propane cylinder in an enclosed area. If storing indoors, disconnect the cylinder.
- Check with your local fire safety authority if you have questions about heater use. Other standards govern the use of fuel gasses and heat producing products for specific uses. If no local codes exist, follow the National Fuel Gas Code, ANSI Z223.1. In Canada, installation must conform to local codes. If no local codes exist, follow current national standards of Canada CAN/CGA-B 149.2.
- This heater is a combustion appliance. All combustion appliances produces carbon monoxide (CO) during the combustion process. This product is designed to produce extremely minute, non-hazardous amounts of CO. **DO NOT** block air flow into or out of the heater.
- For outdoor use **ONLY**. **NEVER** use inside enclosed, non-ventilated areas.
- This heater consumes oxygen. **DO NOT** use in non-ventilated or enclosed area to avoid serious harm.
- **If you smell gas:** 1. Shut off gas to the appliance. 2. Extinguish open flame. 3. If odor continues, immediately call your gas supplier.

IMPORTANT SAFETY INFORMATION

- Keep all connections and fittings clean. Make sure propane cylinder valve outlet is clean.
- Inspect hose before use. Replace if there is evidence of abrasion or wear.
- During set up, check all connections and fittings for leaks using soapy water. **NEVER** use a flame.
- Use as a heating appliance only. **NEVER** alter in any way or use with any device.
- Check entire hose at least annually.
- **NEVER** leave heater unattended when hot or in use.
- During set up, check all connections and fittings for leaks using soapy water. **NEVER** use a flame.
- Keep out of reach of children.
- This product is fueled by propane gas. Propane gas is invisible, odorless, and flammable. An odorant is normally added to help detect leaks and can be described as a “rotten egg” smell. The odorant can fade over time so leaking gas is not always detectable by smell alone.
- Propane gas is heavier than air and leaking propane will sink to the lowest level possible. It can ignite by ignition sources including matches, lighters, sparks or open flames of any kind many feet away from the original leak. Use only propane gas set up for vapor with draw.
- Propane gas should be stored or used in compliance with local ordinances and codes or with ANSI/NFPA 58. Turn off propane when not in use.
- **NEVER** store propane near high heat, open flames, pilot lights, direct sunlight, other ignition sources or where temperatures exceed 120 degrees F (49°C).
- Propane is heavier than air and can accumulate in low places. If you smell gas, leave the area immediately.
- **NEVER** install or remove propane cylinder while heater is lighted, near flame, pilot lights, other ignition sources or while heater is hot to touch.
- This heater is red hot during use and can ignite flammables too close to the burner. Keep flammables at least 3 feet from sides & 2 feet from top. Keep gasoline and other flammable liquids and vapors well away from heater.
- The propane cylinder must always be stored outdoors in a well ventilated space. **NEVER** store propane cylinder in an enclosed area (house, garage, etc.). If heater is to be stored indoors, disconnect the propane cylinder for outdoor storage.



SAVE THESE WARNINGS

FEATURES AND SPECIFICATIONS



FEATURES

This patio heater is ideal to be a heater with multi-purpose that can use on party, wedding, outdoor events, patio, restaurants, pool deck & other type of events. The heater is commercial quality and durable. This multi-purpose heater is ideal for use on your patio, restaurant, pool deck, or for a party, wedding, or any outdoor event (patio heaters are not for use indoors, near combustible materials, or in partially enclosed outdoor areas such as tents).

- Dimensions: 33L x 18W x 89H inches
- Powerful heater creates 48,000 BTUs
- Heats up to 18 feet in diameter
- Unique pilotless system with Piezo ignition
- Accepts any Standard 5 Gallon BBQ Tank
- Convenient wheel assembly
- Patio Heater CE/CSA/ETL approved

PARTS DIAGRAM

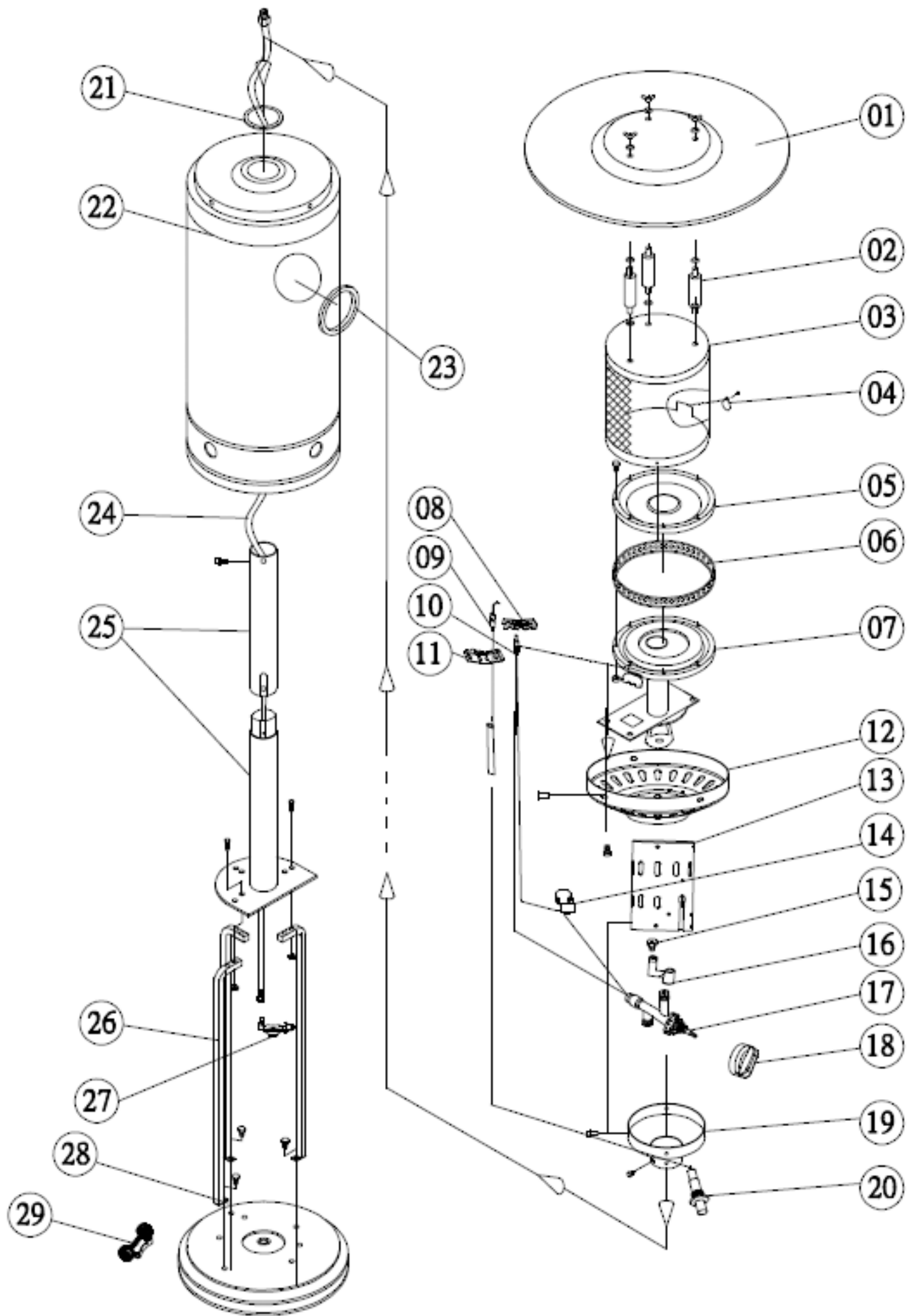

PARTS LIST

PARTS LIST

#	DESCRIPTION	QTY
1	Reflector	1
2	M8 bolt	1
3	Flame Screen	1
4	Watching plate	1
5	Burner cover A	1
6	Fire Ring	1
7	Burner Cover B	1
8	Stator A	1
9	Ignition	1
10	Thermocouple	1
11	Stator B	1
12	Flame Screen Base	1
13	Anti-Tilt Switch	1
14	Connector	1
15	Injector	1
16	Valve Connector	1
17	Valve	1
18	Control Box	1
19	Venturi Box	1
20	Knob	1
21	Ignitor	1
22	Burner Base	1
23	Rubber Ring	1
24	Cylinder Cover	1
25	Rubber Ring	2
26	Regulator & Hose	1
27	Pole (2pcs)	1
28	Stand Support	3
29	Base	1
30	Wheel's Assembly	1
31	Anchoring Arm	3

#	DESCRIPTION	QTY	STEP
1	M6x10 Bolt	8	1, 2
2	M6 NUT	14	1, 2
3	M8 BOLT	3	3
4	M6x22 BOLT	6	4
5	M5x10 SCREW	4	7
6	REFLECTOR STUD	3	7
7	WING NUT	3	10
8	M8 WASHER	6	10
9	ANCHORING ARM	3	2
10	ANCHORING NUT	3	2
11	CUT NUT	9	9
12	SMALL SCREW	9	9
13	WRENCH	1	1,2,3,4,8



The following items are not included, but are necessary for the proper assembly of your heater. **DO NOT** attempt to assemble without proper tools.

- Phillips screwdriver w/ medium blade
- Adjustable opening wrench
- Leak detection solution (See next page)

Note: You must follow all the steps to properly assemble the heater.

ASSEMBLY

Step 1 - Attach Wheels to Base

1. Line up the holes in the wheel bracket with corresponding holes in the base. Insert two **M6 bolts** through holes and then finger tighten two **M6 nuts**.
2. Be sure that the wheel assembly is parallel to the base and fully tighten bolts.

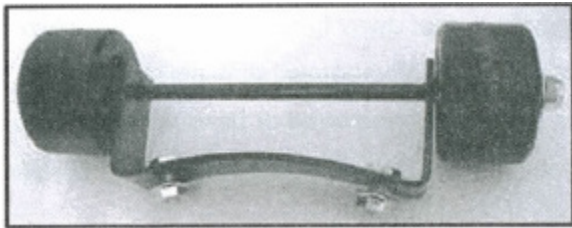

2pcs M6 Bolts:



2pcs M6 nuts:

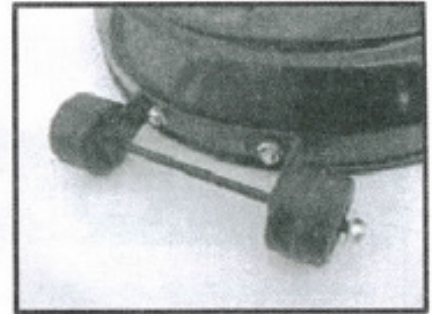
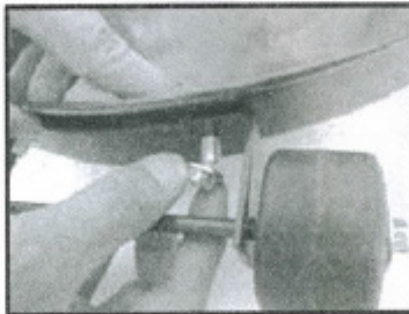

Step 2 - Attach Ground Fixtures to Base

1. Optional ground fixtures (not included with all models)
2. Mount fixtures with six pieces **M6 small bolts** and **M6 nuts** into the holes on the base housing.

3 Anchoring Arm:



3 Anchoring Nut:



6pcs M6 Bolts:



6pcs M6 nuts:



Step 3 - Attach Post Bracket to Base

1. Attach the **Post Brackets** to **Base** with three pieces of **M8 bolts**, use wrench to fasten.

3pcs M8 bolts:



ASSEMBLY

Step 4 - Put Post on Post Bracket

1. Put the lower post on the bracket with six pieces of **M6x22 bolts** and then screw off four pieces **M5x10 screws** from the lower post, then put the upper post to it.

6pcs M6x22 bolt:



6pcs M6 nut:



Step 5 - Place the Tank Housing

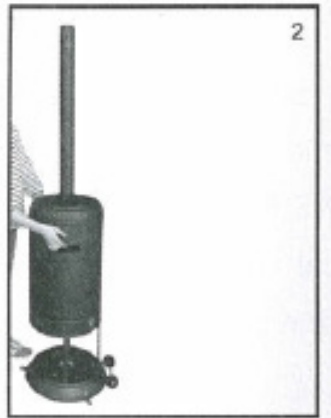

Step 6 - Attach Reflector Studs to Screen Cover

1. Insert three **Reflector Studs**

2. Tighten studs securely



3 Req'd Reflector Studs

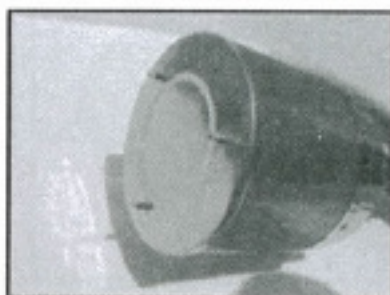

ASSEMBLY

Step 7 - Attach Head Assembly to Post

1. Screw off four small **screws**, then load head assembly by inserting the hose into the post. The control knob should be above on the post. Attach the head assembly to the post and loosely install four small bolts, tightening them securely. Then fasten the lower post and upper post with four **M5x10 screws**.

4 small screws:



4pcs M5x10screws:



Step 8 - Install the Reflector

NOTE: Leave all screws and nuts loose until the entire shield is put together to ensure proper alignment. Tighten after sections are aligned.

1. Slide the two **reflector panels** together then insert one **small screw**.

9 Req'd Small Screws



9 Req'd Cap Nuts

■ Attach Cap Nut and leave loose.

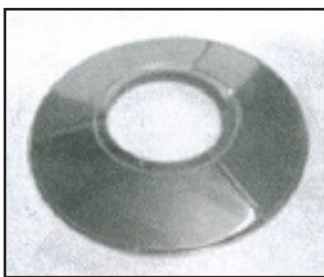
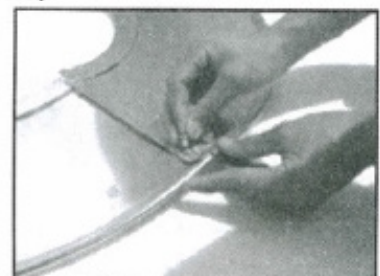
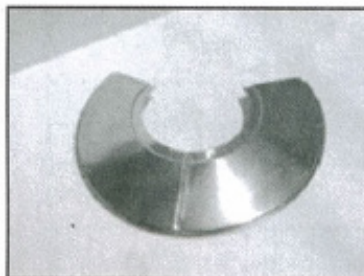
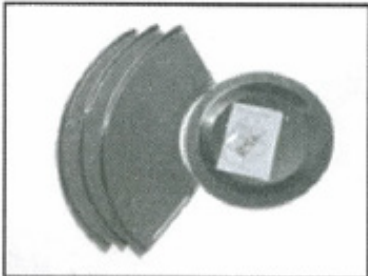

2. Place the **reflector center plate** into the middle of the **reflector panels** and repeat the procedure above.

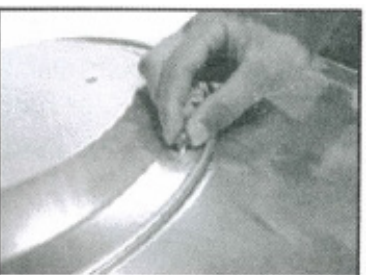

ASSEMBLY

3. Repeat the procedure to complete assembly of all four sections. Fully tighten all screws.

Step 9 - Attach Reflector Assembly to Studs

1. Support the heater then slide three large **flat washers** over the threaded end of the studs.



6 Req'd Large Flat Washers 3 Req'd Wing Nuts

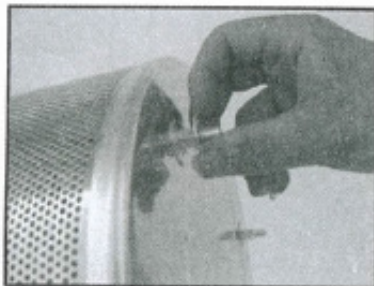
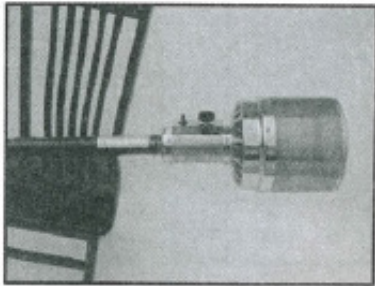

3. Locate the reflector assembly on three studs.

4. Install large, **flat washers** on studs and securely tighten the wing nuts but do not over tighten them.

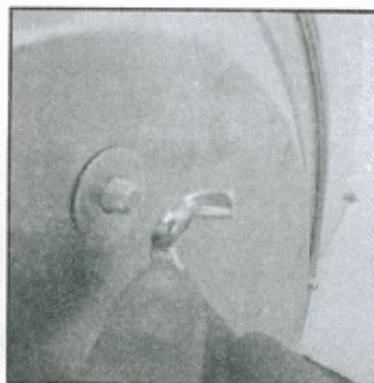
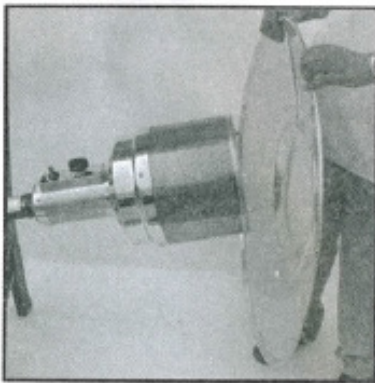

Step 10 - Connect Hose and Reflector to Cylinder

NOTE: You must provide propane gas and the propane cylinder. Use a 20lb cylinder only.

NOTE: Use this heater only with a propane vapor withdrawal supply system.

The minimum permissible gas supply pressure of 10 W.C. is required for the purpose of input adjustment.

The minimum hourly of 17,000 BTU's is the required input rating for a heater for automatic operation at ratings less than full input rating.

The pressure regulator and hose assembly supplied with the appliance must be used.

The installation must conform with local codes, or in the absence of local codes, with the National Fuel Gas Code, ANSI Z223.1.

The propane cylinder must be constructed and marked in accordance with the specifications for LP Gas Cylinders of the US Dept. of Transportation.



ASSEMBLY

NEVER connect an unregulated propane cylinder to the heater.

A dented, rusted or damaged propane cylinder may be hazardous and should be checked by the cylinder supplier. NEVER use a propane tank with a damaged valve connection.

Attach the regulator to the cylinder. Complete attachment.

Install the cylinder.



WARNING

- Perform all leak tests outdoors • Extinguish all open flames • NEVER leak test while smoking
- DO NOT use the heater until all connections have been leak tested and found to not leak.

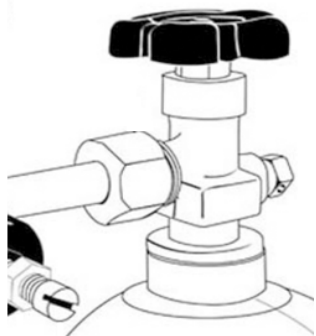

LEAK CHECK

- Make 2-3oz of leak check solution (one part dish soap to three parts water).
- Apply several drops where the hose attaches to the regulator, do the same for the area where the regulator connects to the cylinder.
- Make sure all heater and light valves are **OFF**.
- Turn the cylinder valve **ON**. If any bubble appear, there is a leak. Turn the cylinder valve **OFF**.
- If the leak is at the cylinder hose/regulator connection: Disconnect, reconnect and perform another leak test. If you continue to see bubbles after several attempts, the cylinder valve is defective and should be returned to the place of purchase.
- If **NO** bubbles appear at any connection, the connections are secure.
- Turn the cylinder valve **OFF** and complete installation.

NOTE: Whenever the gas connections are loosened or removed, you must perform a complete leak test.



FOR OUTDOOR USE ONLY. NEVER USE INSIDE A HOUSE OR OTHER UNVENTILATED OR ENCLOSED AREAS. THIS HEATER CONSUMES AIR (OXYGEN).



EXPLOSION - FIRE HAZARD

- **NEVER** store propane near high heat, open flames, pilot lights, direct sunlight or other ignition sources or where temperatures exceed 120°F (49°C).
- Propane vapors are heavier than air and can accumulate on low places. If you smell gas, leave the area immediately.
- **NEVER** install or remove cylinder while the heater is lit, near flame, pilot lights, other ignition sources or while the heater is hot to the touch.
- This heater is red hot during use and can ignite flammables that are too close to the burner. Keep flammables at least 2 feet from the sides and 3 feet from the top. Keep gasoline and other flammable liquids and vapors well away from the heater.
- The propane cylinder must always be stored outdoors in a well ventilated space. **NEVER** store the propane cylinder in an enclosed area. If the heater is to be stored indoors, disconnect the propane cylinder for outdoor storage.

To Turn the Heater On:

1. Turn on the valve on the gas supply to the cylinder.
 2. Press and turn the variable control knob to the **HIGH** position.
 3. Press down the variable control knob, press the **IGNITOR** button several times until the burner head flame ignites. Release the variable control knob 10 seconds after the ignition.
- If a new tank has just been connected, allow at least one minute or more for the air in the gas pipeline to purge out through the pilot hole, or simply do step 3.
 - When lighting the flame, make sure the variable control knob is continuously depressed while pressing the **IGNITOR** button. The variable control knob can be released after the flame is lit for 10 seconds.
 - The flame can be detected and watched through the peep-hole located on the base of the burner.
 - If only a small flame is needed, turn the variable control knob to the **LOW** position.
4. Turn the variable control knob to **LOW** position for 5 minutes or more before turning the knob to the desired temperature setting.
 5. If the burner flame accidentally goes out, turn the heater **OFF** and wait at least 5 minutes to let the gas dissipate before lighting again to avoid a possible explosion. Repeat steps 2 through 4.

To Turn the Heater Off:

1. Press and turn the control knob to the **OFF** position.
2. Turn off the valve on the gas cylinder and disconnect the cylinder.

WARNING

- The whole gas system, hose, regulator, pilot or burner should be inspected for leaks before use.
- Check the hose assembly for signs of extreme abrasion, cuts or wear. Suspected areas should be leak tested.
- Avoid twisting the flexible tubes and hoses.
- Make sure the ventilation opening of the cylinder enclosure, control compartment, burner and circulation air passageways of the heater are free and clear of debris. If spider or insect nests are detected, clean the holes with heavy-duty pipe cleaner or compressed air.
- **ALWAYS** keep a dry chemical fire extinguisher readily available.
- For safety, always allow at least a five minute shut off period to pass before re-lighting the heater.
- Maximum Working Pressure: 250 PSIG

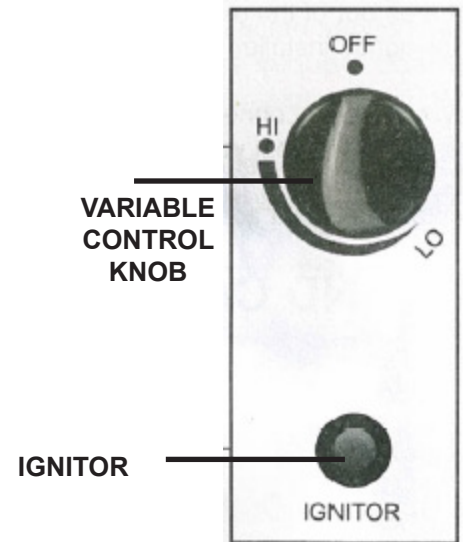

Cleaning and Care:

- Wipe off powder coated surfaces with a soft, moist rag and soapy water. **NEVER** clean the heater with cleaners that are combustible or corrosive.
- If carbon deposits develop, remove the reflector and flame screen and clean them with soapy water. **DO NOT** paint the flame screen, control panel or reflector.
- Cover the burner unit with the supplied cover when the heater is not in use. Wait until the heater is cool to the touch before covering.
- In a salt-air environment, such as near the ocean, corrosion occurs more quickly than normal. Check frequently for corroded areas and repair them promptly.

First Aid for Burns:

- **EYES:** Seek medical attention **IMMEDIATELY**. **DO NOT** put ointments or liquid in eyes.
- Consult a doctor if the burn is not healed within 24 hours, or if the burn is larger than the size of you palm.
- If possible, run the affected area under cold water, not ice or ice water, for 10-15 minutes if the skin is intact. Cut and gently lift away clothing covering the burned area. **DO NOT** put any creams or grease on the burned area.
- **DO NOT** pop any blisters, cover the area with gauze dressing.

TROUBLESHOOTING

PROBLEM	POSSIBLE CAUSE	POSSIBLE SOLUTION
BURNER WON'T LIGHT	1. Propane cylinder is frosted over 2. Blockage in orifice 3. Control knob is not in ON position	1. Wait until the propane cylinder warms up and becomes unfrosted 2. Clear blockage 3. Turn control knob to ON
BURNER FLAME GOES OUT IMMEDIATELY AFTER IGNITION	Low gas pressure	Call your gas supplier
DELAYED IGNITION	1. Main burner carry over ports clogged 2. Low gas supply pressure	1. Clean main burner ports 2. Call your gas supplier
INADEQUATE COMBUSTION ON BURNER	Not enough air	Check air passageways for dirt and debris, clean with compressed air
BURNER FLAME IS LOW	1. Supply hose is bent or twisted 2. Blockage in burner injector	1. Straighten and perform leak test on hose 2. Clean or replace burner injector
EMITTER GLOWS UNEVEN	1. Blockage in burner injector 2. Base is not on a level surface 3. Low gas pressure	1. Clean or replace burner injector 2. Place heater on level surface 3. Replace cylinder with new one
SLIGHT SMOKE AND/OR ODOR DURING INITIAL OPERATION	Residue from manufacturing process	Will stop after approx 30 minutes of operation
THICK BLACK SMOKE	Blockage in burner	Turn off the heater and let it cool. Remove blockage and clean the burner inside and outside
HEATER PRODUCES WHISTLE NOISE WHEN BURNER IS LIT	1. Air passageways are blocked 2. Air in the gas line	1. Check minimum installation clearances and air passageways for debris 2. Operate burner until the air is completely purged
HEATER PRODUCES A CLICKING NOISE AFTER THE BURNER IS LIT OR TURNED OFF	Metal expanding and contracting	This is common with heaters. If noise is excessive, contact a qualified technician
GAS ODOR WHEN CONTROL KNOB IS IN OFF POSITION	1. Gas leaks 2. Gas control defective	1. Locate and correct leaks immediately 2. Replace gas control
GAS ODOR DURING COMBUSTION	1. Foreign matter in gas or burner ports 2. Heater burning vapors from paint, impurities in the air 3. Gas leakage from regulator and hose connection, valve and pipes connection, pipes	1. Check gas passageways and burner 2. Stop storing and using odor causing products near the heater. 3. Locate and correct leaks, or contact your gas supplier
CARBON BUILD-UP	Dirt or film on reflector and flame screen	Clean reflector and flame screen

MAINTENANCE

PLEASE READ THE FOLLOWING CAREFULLY

THE MANUFACTURER AND/OR DISTRIBUTOR HAS PROVIDED THE PARTS LIST AND ASSEMBLY DIAGRAM IN THIS MANUAL AS A REFERENCE TOOL ONLY. NEITHER THE MANUFACTURER OR DISTRIBUTOR MAKES ANY REPRESENTATION OR WARRANTY OF ANY KIND TO THE BUYER THAT HE OR SHE IS QUALIFIED TO MAKE ANY REPAIRS TO THE PRODUCT, OR THAT HE OR SHE IS QUALIFIED TO REPLACE ANY PARTS OF THE PRODUCT. IN FACT, THE MANUFACTURER AND/OR DISTRIBUTOR EXPRESSLY STATES THAT ALL REPAIRS AND PARTS REPLACEMENTS SHOULD BE UNDERTAKEN BY CERTIFIED AND LICENSED TECHNICIANS, AND NOT BY THE BUYER. THE BUYER ASSUMES ALL RISK AND LIABILITY ARISING OUT OF HIS OR HER REPAIRS TO THE ORIGINAL PRODUCT OR REPLACEMENT PARTS THERETO, OR ARISING OUT OF HIS OR HER INSTALLATION OF REPLACEMENT PARTS THERETO.

Record Product's Serial Number Here: _____

Note: If product has no serial number, record month and year of purchase instead.

Note: Some parts are listed and shown for illustration purposes only and are not available individually as replacement parts.



SAVE THESE INSTRUCTIONS.



Questions, problems, missing parts?

Before returning to your retailer, our exceptional customer service is available.

Call us Tel: **909 628 0880**

Hour : **9am To 3pm PST (Monday to Friday)**

Email : **customer@xtremepowerusa.com**

PRODUCT MADE IN CHINA