

## decora plus™ Screwless Wallplates

For Decora Plus™  
and Decora® Wiring Devices

### Application

For use in all commercial, industrial, institutional and residential installations to cover Decora Plus and Decora wiring devices in receptacle and/or switch boxes in compliance with the NEC® and other regulatory codes.

### Features and Benefits:

- Screwless, snap-on design for contemporary architectural styling
- Complete kit includes screwless snap-on wallplate and subplate
- Constructed of durable polycarbonate to withstand abuse
- Subplate provides an easy, convenient wallplate installation with proprietary flat head combination head screws held captive
- Accent any wall covering with wide selection of colors
- Designed with top and bottom ratchets on single/multi-gang configurations and side ratchets on multi-gang configurations for a secure fit
- 1-6 Gang screwless wallplates each paired with a dedicated subplate for fast and easy installation
- ETL Listed
- Backed by Leviton's Limited Ten-Year Warranty



# PRODUCT SPECIFICATIONS

## Testing and Code Compliance:





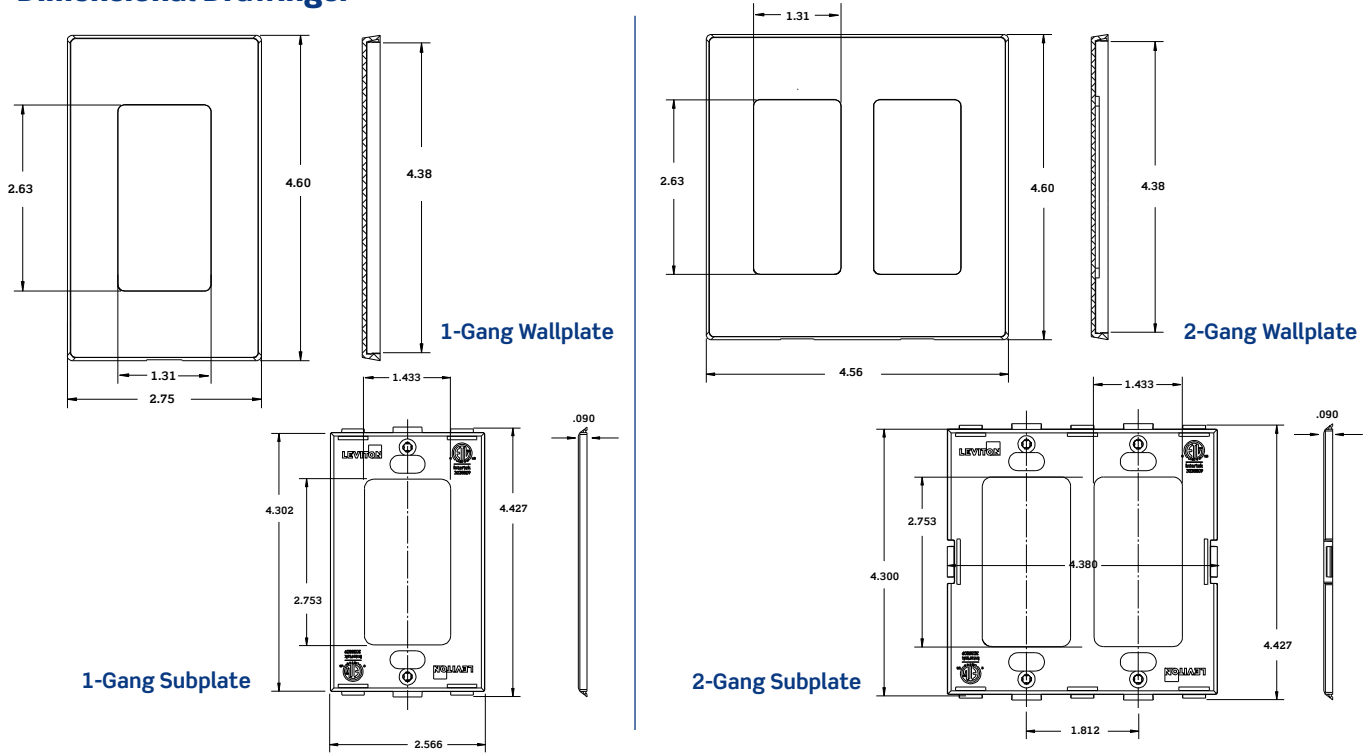

All wallplates are listed by ETL and meet material test standards of ANSI, NEMA WD-1 and NFPA. High dielectric strength and arc resistance, meeting or exceeding UL Standard 514 D.

These wallplates are suitable for use in accordance with state, country, municipal and local codes, including ANSI/NFPA National Electrical Code® and the OSHA Code.

## Dimensional Drawings:



## Ordering Information:

Description	Wallplate Dimensions	White	Ivory	Light Almond	Gray	Black	Brown
1-gang 	2.750 x 4.609	80301-SW	80301-SI	80301-ST	80301-SGY	80301-SE	80301-S
2-gang 	4.562 x 4.609	80309-SW	80309-SI	80309-ST	80309-SGY	80309-SE	80309-S
3-gang 	6.374 x 4.609	80311-SW	80311-SI	80311-ST	80311-GY	80311-SE	80311-S
4-gang 	8.186 x 4.609	80312-SW	80312-SI	80312-ST	80312-GY	80312-SE	80312
5-gang 	9.998 x 4.609	80321-SW	—	80321-ST	—	—	—
6-gang 	11.810 x 4.609	80326-SW	80326-SI	80326-ST	—	—	—

### Leviton Manufacturing Co., Inc. World Headquarters

201 North Service Road, Melville, NY 11747-3138  
 Telephone: 1-800-323-8920 FAX: 1-800-832-9538  
 Tech Line (8:30AM-7:00PM E.T. Monday-Friday): 1-800-824-3005

Visit our Website at: [www.leviton.com](http://www.leviton.com)

© 2017 Leviton Manufacturing Co., Inc. All rights reserved.

