

Item # : CHL26
Assembly Instructions

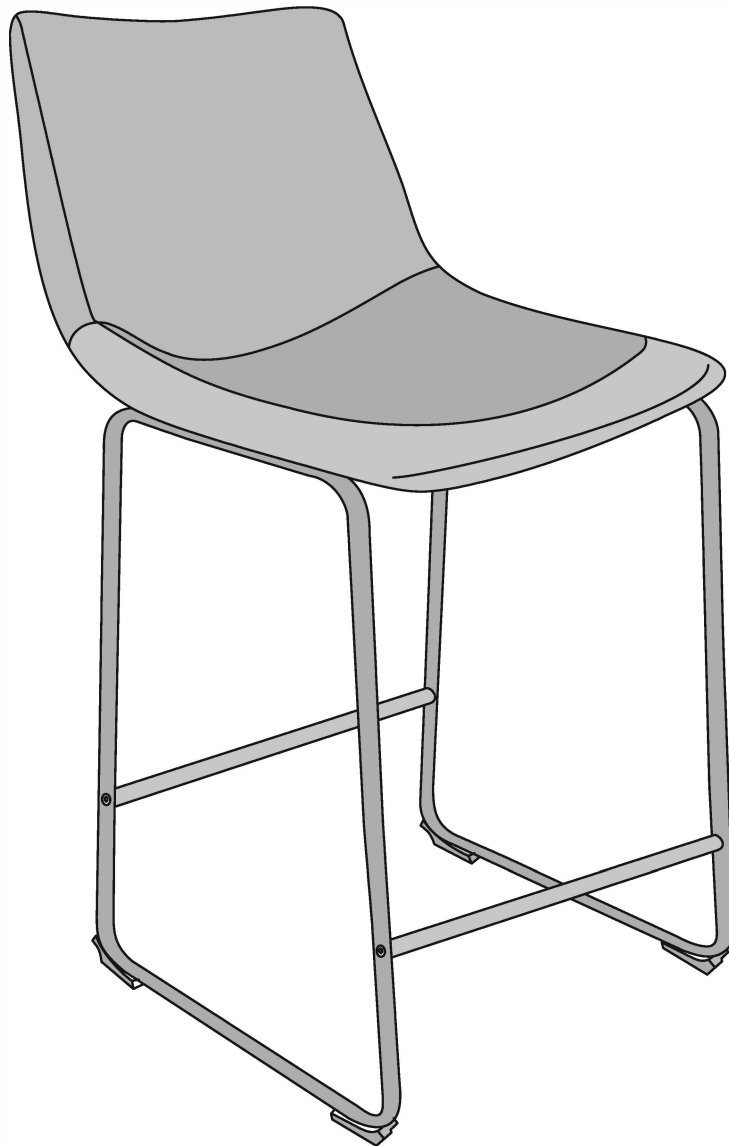



Please visit our website for the most current instructions, assembly tips, report damage, or request parts. www.walkeredison.com

Revised 03/2017

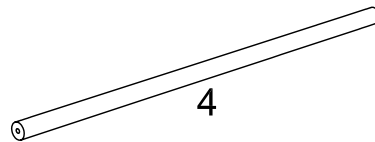
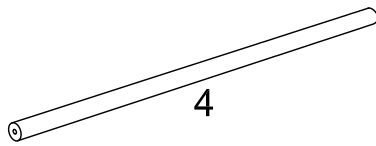
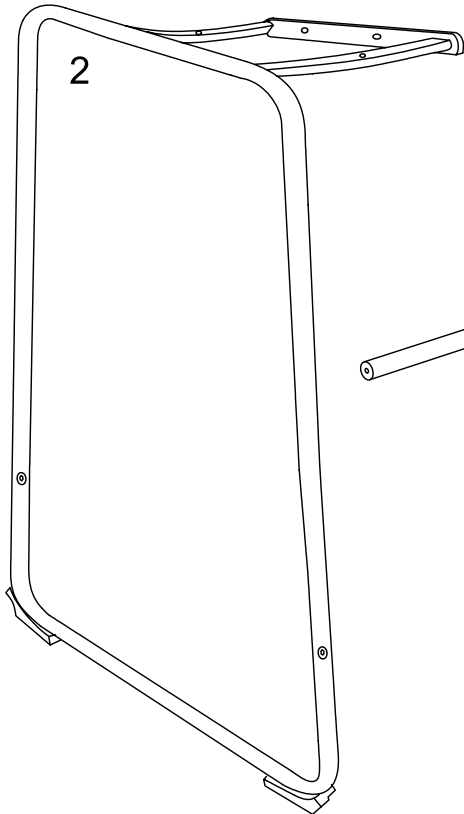
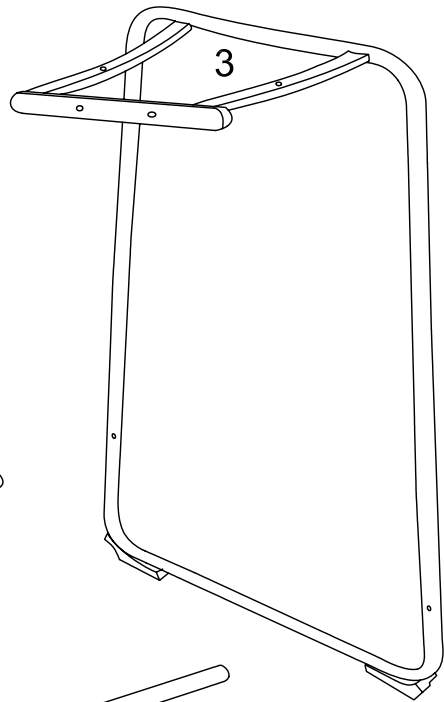
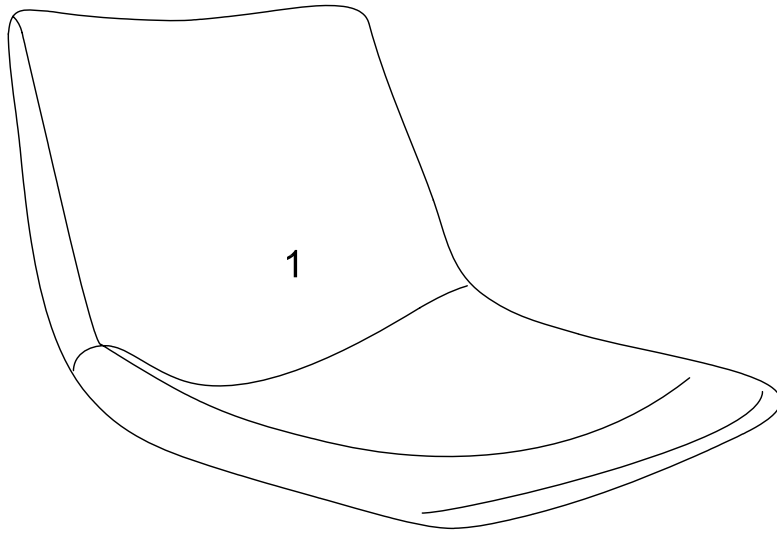
Parts List



Hardware List

A		M6*30mm	Bolt	4 pcs
B		M8*14mm	Bolt	2 pcs
C		M6*25mm	Bolt	4 pcs
D			Spring washer	4 pcs
E			Washer	4 pcs
F		M4mm	Wrench	1 pc

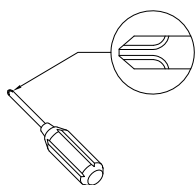

Philips head screwdriver required for assembly
(not included)

*The hardware quantities listed above are required for proper assembly.
Some extra hardware may also have been included.*

Step 1

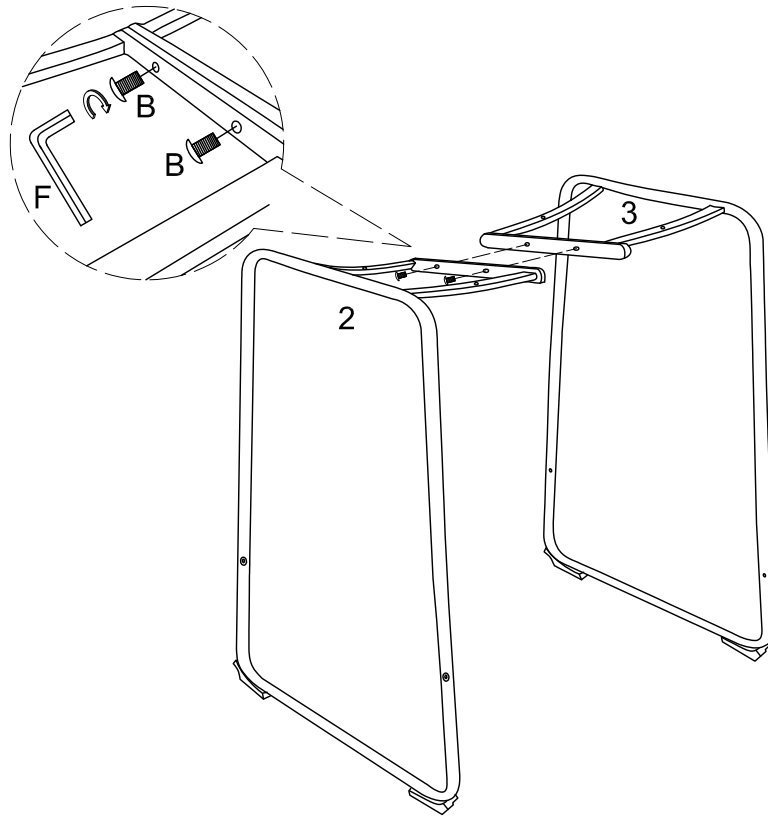

Attach the metal frame (2) to metal frame (3) by using bolts (B) and wrench (F). Do not tighten bolts completely until step #2.

Step 2

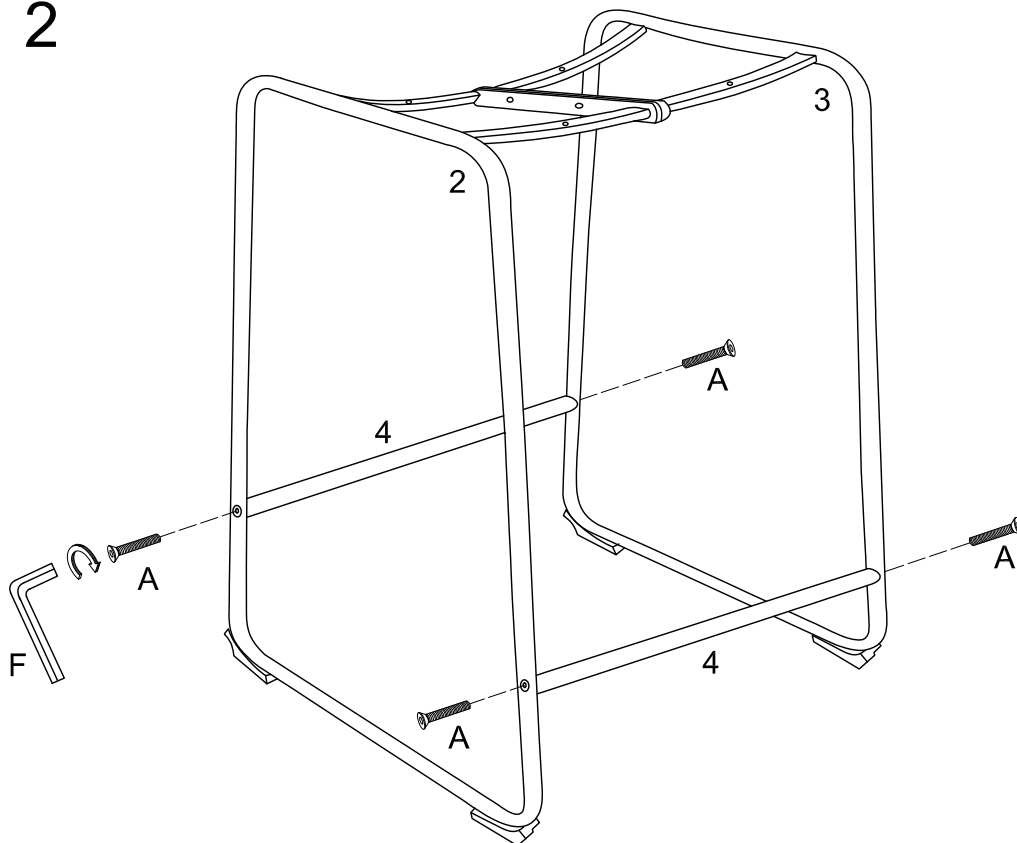

Attach the metal tubes (4) to the metal frame (2)(3) and secure it by using bolts (A) and wrench (F). Tighten bolts from assembly in Step 1.

Step 3

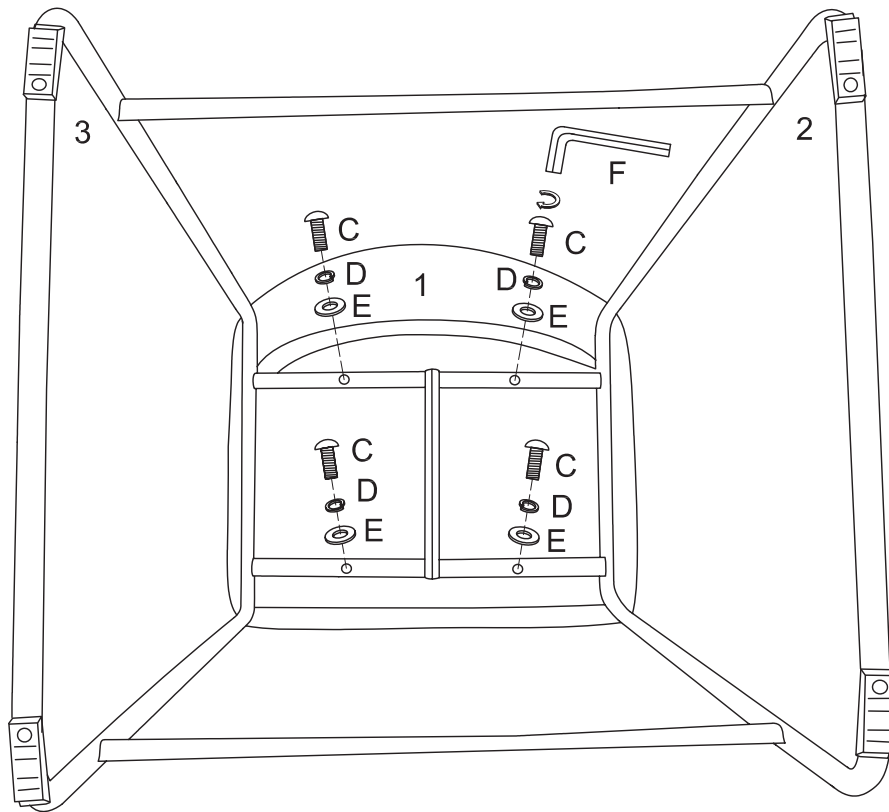

Attach the seating frame (1) to the metal frame (2)(3) and secure it by using washers (E), spring washers (D) and wrench (F).

Step 4

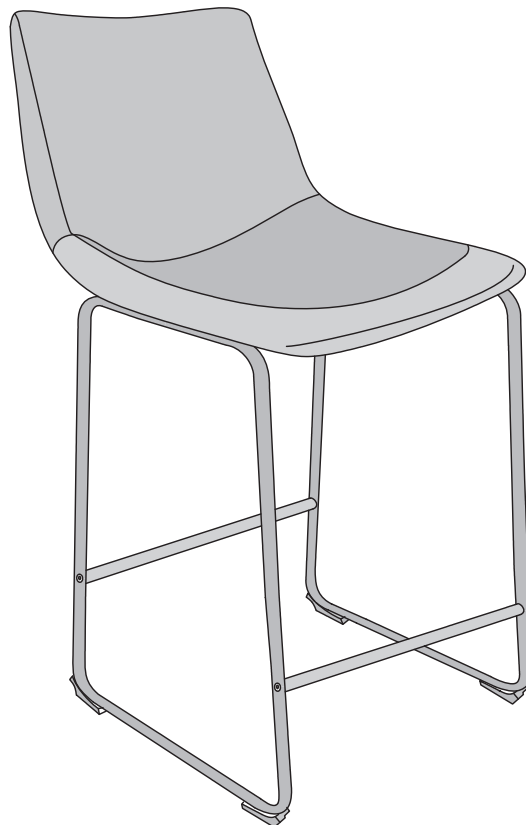

Final Assembly