

# Installation and Operation Instructions

ELECTRIC FIREPLACE

**X30WMEF1BLK X30WMEF1WHT**

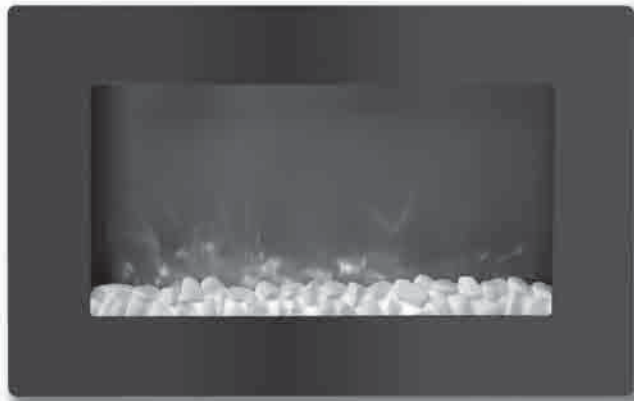

## **READ & SAVE THESE INSTRUCTIONS**

Carefully read and review before assembling, installing, operating or maintaining this product. Observe all safety instructions and information.

**FAILURE TO FOLLOW WARNINGS & OPERATIONAL INSTRUCTIONS CONTAINED IN THIS MANUAL CAN RESULT IN PROPERTY DAMAGE OR PERSONAL INJURY.**



**Read these instructions completely before beginning installation. Failure to follow them could cause a heater malfunction resulting in serious injury and/or property damage.**



**WARNING:** All electric heaters have hot and arcing or sparking parts inside. Do not use it in areas where gasoline, paint or flammable liquids are present.



**WARNING:** This electric fireplace is tested and listed for use only with the optional accessories listed in these instructions. Use of optional accessories not specifically tested for this electric fireplace could void the heater warranty and/or result in a safety hazard.

This electric fireplace meets the construction and safety standards of H.U.D. for application in manufactured homes when installed according to these instructions.

## TABLE OF CONTENTS

Important Safety Instructions .....	4-6
Listing Approvals .....	7
Product Dimensions .....	8
Locating Fireplace .....	9
Unpacking and Testing Fireplace .....	10
Grounding Instructions .....	10
Installation .....	11-12
Finishing Checklist .....	13
Operating Instructions .....	13-14
Replacing The Rock/Log Set And Light Bulbs .....	15
Maintenance .....	16
Trouble shooting .....	17

## IMPORTANT SAFETY INSTRUCTIONS

- 1 Prior to plugging your heater into an electrical outlet, verify that the house circuit breakers for the outlet are on.
- 2 The heater may emit a slight, harmless odor when first used. This odor is normal and it is caused by the initial heating of internal heater elements and will not occur again.
- 3 If your heater does not emit heat, consult the operation section of this manual for further information.
- 4 Use with a CSA or UL certified surge protector.



CAUTION:  
RISK OF ELECTRIC SHOCK  
DO NOT OPEN  
NO USER-SERVICEABLE PARTS INSIDE  
HIGH TEMPERATURE



KEEP ELECTRICAL CORDS, DRAPERY AND OTHER FURNISHINGS AT LEAST 3 FEET (0.9m) FROM THE TOP, FRONT AND SIDES OF THE HEATER.

**!** CAUTION: High temperature, risk of fire. Keep electrical cords, drapery, furnishings, and other combustibles at least 3 feet (0.9m) from the top, front and sides of the heater, and away from the side and rear.

**!** WARNING: Servicing should be done only while the heater is disconnected from the power supply circuit.

## IMPORTANT SAFETY INSTRUCTIONS

When using this electric fireplace, basic precautions should always be followed to reduce the risk of fire, electric shock and injury to persons, including the following:

1. Read all instructions before using this electric fireplace.
2. This heater is hot when in use. To avoid burns, do not let bare skin touch hot surfaces. Keep combustible materials, such as furniture, pillows, bedding, papers, clothes and curtains at least 3 feet (0.9m) from top, front and sides of heater.
3. Extreme caution is necessary when any heater is used by or near children and whenever the heater is left operating and unattended.
4. Always unplug electric fireplace when not in use.
5. Do not operate this electric fireplace with a damaged cord or plug or after heater malfunctions, has been dropped or damaged in any way. Return heater to authorized service facility for examination, electrical or mechanical adjustment or repair.
6. Do not use this electric fireplace outdoors.
7. This electric fireplace is not intended for use in bathrooms, laundry areas and similar indoor locations. Never locate electric fireplace where it may fall into a bathtub or other water container.
8. Do not run cord under carpeting. Do not cover cord with throw rugs, runners or the like. Arrange cord away from traffic area and where it will not be tripped over.
9. To disconnect electric fireplace, turn controls to "OFF" before removing plug from outlet.
10. Connect to properly grounded outlets only.

## IMPORTANT SAFETY INSTRUCTIONS

11. Do not insert or allow foreign objects to enter any ventilation or exhaust opening as this may cause an electric shock or fire or damage the heater.
12. To prevent possible fire, do not block air intakes in any manner. Do not use on soft surfaces, like a bed, where openings may become blocked.
13. The electric fireplace has hot and arcing or sparking parts inside. Do not use it in areas where gasoline, paint or flammable liquids are used or stored.
14. Use this electric fireplace only as described in this manual. Any other use not recommended by the manufacturer may cause fire, electric shock or injury to persons.
15. Avoid the use of an extension cord because the extension cord may overheat and cause a risk of fire. However, if you have to use an extension cord, the cord should be No. 14 AWG minimum size and rated not less than 1875 WATTS.
16. Always use properly grounded fused and polarized outlets.
17. Always use ground fault protection where required by electrical codes.
18. Always disconnect power before performing any cleaning, maintenance or relocation of heater.
19. To prevent a possible fire, do not burn wood or other materials in this electric fireplace.
20. To prevent electric shock or fire, always hire a certified electrician should new circuits or outlets be required.
21. When transporting or storing this electric fireplace, keep in a dry place free from excessive vibration and store as to avoid damage.

**SAVE THESE INSTRUCTIONS!**

## LISTING APPROVALS

This heater has been tested in accordance with the CSA Standards for fixed and location-dedicated electric room heaters in the United States and Canada. If you need assistance during installation, please contact your local dealer.

Model Number:	X30WMEF1BLK X30WMEF1WHT
Description:	Wall Mount Electric Fireplace
Voltage:	110-120V AC, 60Hz
Watts:	MAX 1400W
Length:	30.6 "
Height:	19.2 "
Depth:	5.7 "

Note: This heater must be electrically wired and grounded in accordance with local codes or, in the absence of local codes, with National Electric Code ANSI/NFPA 70-latest edition or the Canadian Electric Code, CSA C22.1 as appropriate.

# PRODUCT DIMENSIONS

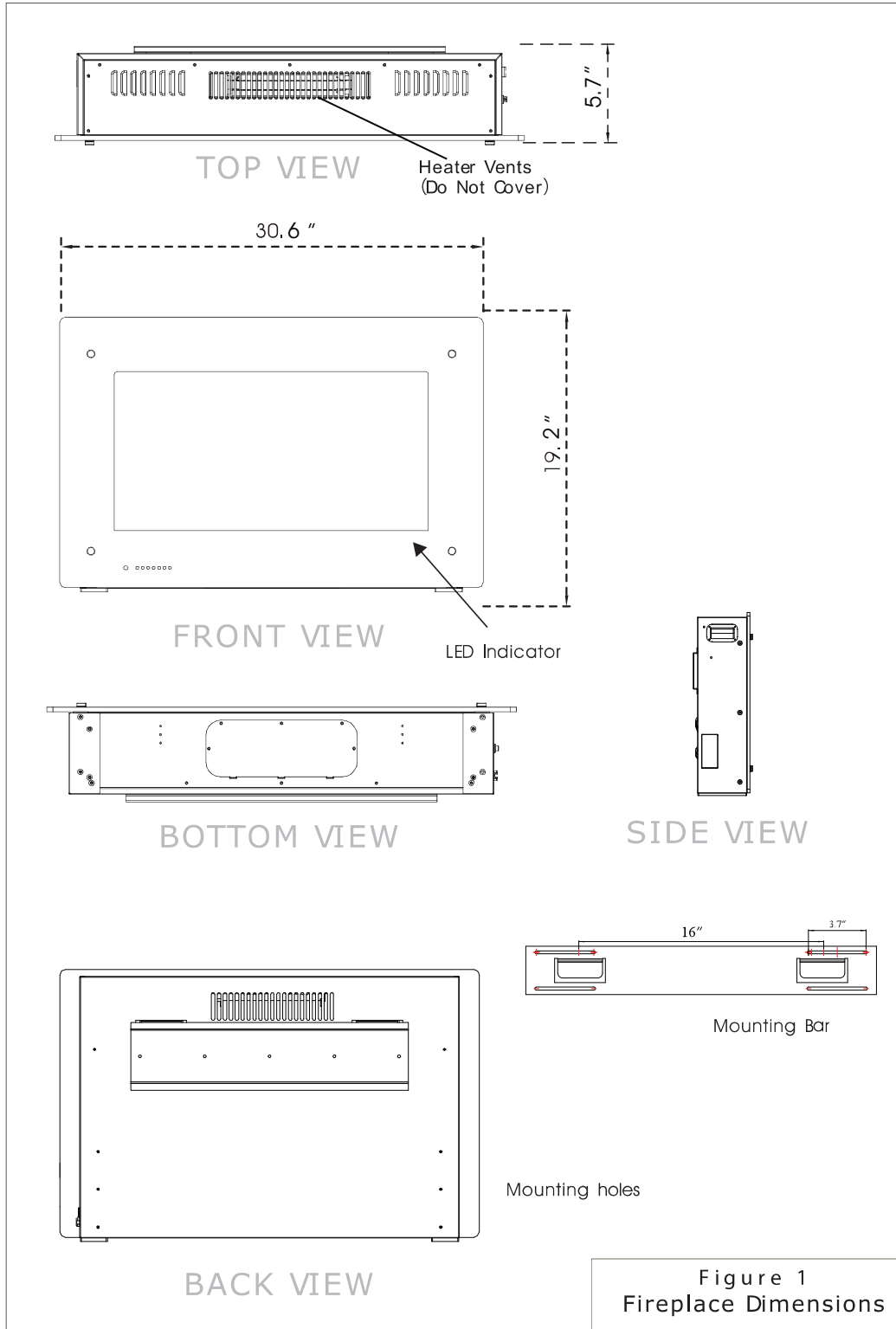



## LOCATING FIREPLACE



**WARNING:** Due to high temperatures, this electric fireplace should be located out of traffic. Keep combustible materials such as furniture, pillows, bedding, papers, clothes and curtains at least 3 feet (0.9m) from top, front and sides of heater.



**WARNING:** Never locate this electric fireplace where it may fall into a bathtub or other water container.



**CAUTION:** Do not expose the electric fireplace to the elements (such as rain, etc.)



**CAUTION:** Wear gloves and safety glasses for protection during installation and maintenance.



**WARNING:** To prevent contact with sagging or loose insulation, the electric fireplace must not be installed against vapor barrier or exposed insulation. Localized overheating could occur and a fire could result.

## UNPACKING AND TESTING FIREPLACE

Carefully remove the unit from the box. Prior to installing the unit, test to make sure the unit operates properly. To do this, plug the unit's power supply cord into a conveniently located 120-Volt grounded outlet.

## GROUNDING INSTRUCTIONS

This insert is for use with 120 Volts. The cord has a plug as shown in (A) of Figure 2 given below. An adapter as shown in (C) is available for connecting three-blade grounding-type plugs to two-slot receptacles. The green grounding plug extending from the adapter must be connected to a permanent ground such as a properly grounded outlet box. The adapter should not be used if a three-slot grounded receptacle is available.

To disconnect heater, turn controls to off, then remove plug from outlet.

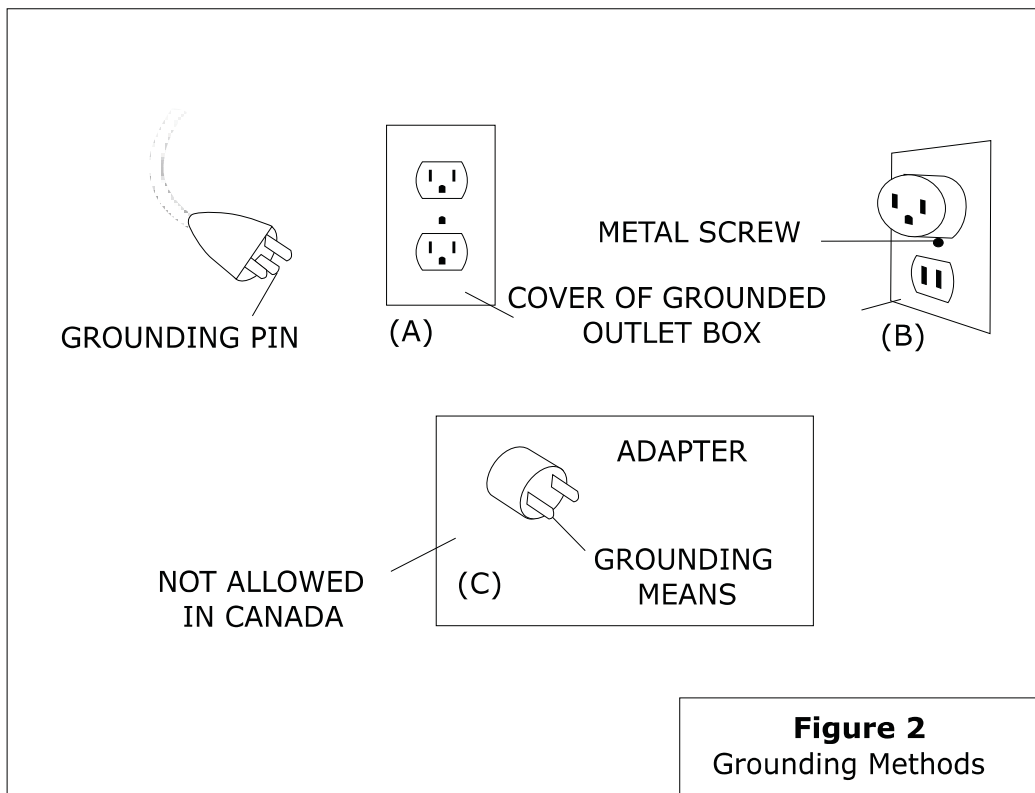

## INSTALLATION



**WARNING: RISK OF FIRE!** The power cord must not be pinched or against a sharp edge. Secure cord to avoid tripping or snagging to reduce risk of fire, electric shock or personal injury. Do not run cord under carpeting. Do not cover cord with throw rugs, runners or the like. Arrange cord away from traffic area and where it will not be tripped over



**WARNING: RISK OF FIRE!** To prevent a possible fire, do not block air intake or exhaust in any manner. Do not use on soft surfaces where openings may become blocked.



**WARNING: RISK OF FIRE!** Do not blow or place insulation against the fireplace.



**WARNING:** This electric fireplace is tested and listed for use only with the approved optional accessories. Use of optional accessories not specifically tested for this electric fireplace could void the heater warranty and/or result in a safety hazard.



**WARNING:** If the information in these instructions is not followed exactly, a fire or explosion may result causing property damage, personal injury or death. Do not store or use gasoline or other flammable vapors in the vicinity of this or any other heater.

# INSTALLATION

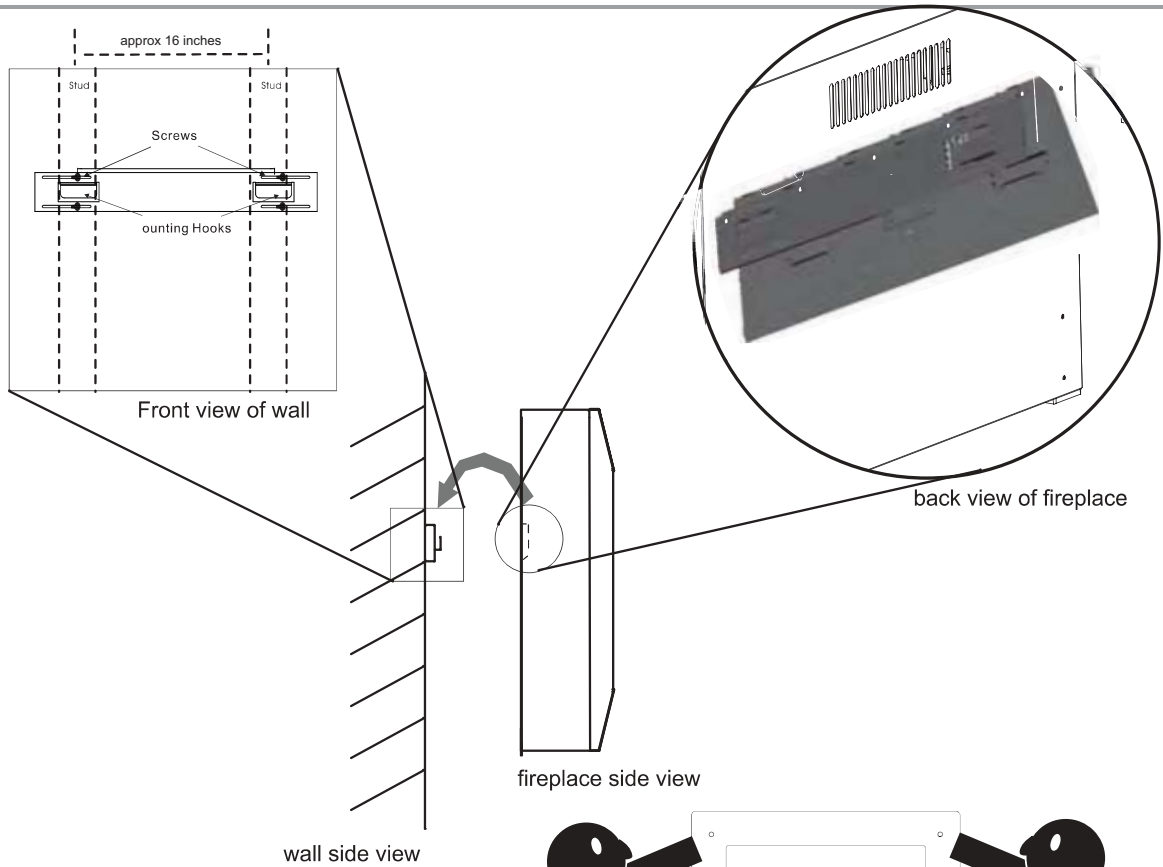

**Figure 3**  
Grounding Methods

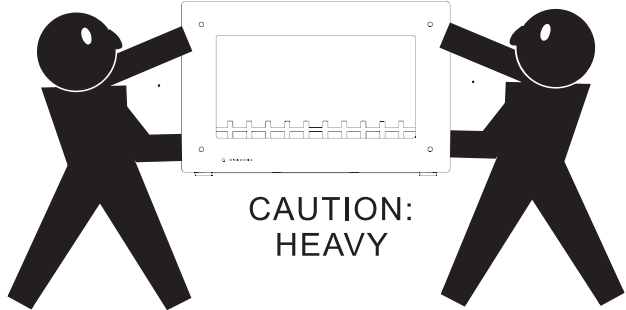

**!** This fireplace must be mounted on a wall with a height above the floor between 0.5M (1.64 Feet) and 2.5M (8.2 Feet).

**!** **WARNING:** Heater vents (see Figure 1, page 8) on this electric fireplace cannot, in any way, be covered as it may create a fire hazard.

**!** Due to the many different materials used on different walls, it is highly recommended that you consult your local hardware store to determine what type of mounting screws are needed before you install this fireplace onto the wall.

## FINISHING CHECKLIST

>Power supply service must be completed prior to finishing to avoid reconstruction.

>Heater vents and air openings cannot be covered in any circumstances.

## OPERATING INSTRUCTIONS

Once the unit has been properly connected to a grounded electrical outlet, it is ready to operate.

Note: Ensure the house circuit breakers for the power supply are turned on.

### **Main Power Switch:**

The Main Power Switch is located on the right side of the unit. Figure 4 illustrates the location of the switch. The "I" indicates ON and "O" indicates OFF. Push the switch to "I" to turn on the unit and the flame effect. The red LED indicator will be turned on

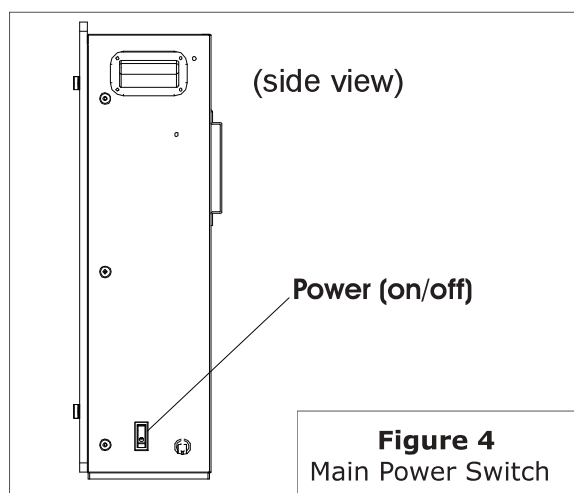

## OPERATING INSTRUCTIONS

The manual controls are located on the left side of the fireplace.  
You have the following controls:

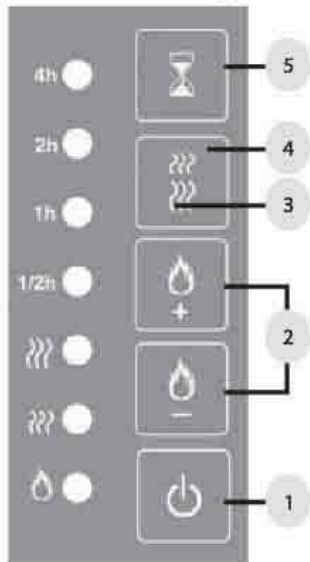

### OPERATING BY REMOTE CONTROL

1. Power ON/OFF: Power to the unit
2. Flame brightness controls: Allows you to adjust the flame to suit your mood. Press to increase flame brightness and to decrease flame brightness. You must press the button several times to see the full flame effect.
3. Low heat: 700 watts
4. High heat: 1400 watts  
Please note: The heater touch panel control must be pressed 2 times to achieve high heat.
5. Heater Timer: Allows you to leave your heater on while you sleep with an automatic timer for shut off. You can set your heater to be on for 1/2 hour increments starting at a 1/2 hour up to a maximum of 7-1/2 hours press once for each 1/2 hour increment. After you reach 7-1/2 hours the next press will shut off the feature.

1. Plug in your electric fireplace.
2. Make sure the main power ON/OFF switch is ON! The remote control will NOT work if the main power switch is OFF.
3. When operating the remote control, it must be pointed towards the front of the unit.
4. The ON/OFF button at the bottom right of the remote is the main ON/OFF power button (Figure 5). Pressing this button activates the power to the unit.
5. Press the button to cycle through LO, HI and OFF.
6. To adjust the flame height and ember bed brightness, press the “” or “” buttons. To increase the flame height and ember bed brightness, press the “” button. To decrease the flame height and ember bed brightness, the “” button. There are five levels of flame effects.
7. To turn off the fireplace, press the ON/OFF button once. NOTICE: This remote control must remain within 8 meters or 26 feet of the fireplace to be effective.



**Figure 5**  
Remote Control For  
Electric Fireplace

# Replacing The Rock/Log Set And Light Bulbs

TO CHANGE LOG/ROCK SET (NOTE: MAKE SURE FIREPLACE IS TURNED OFF AND HAS BEEN UNPLUGGED FROM ELECTRICAL OUTLET BEFORE ATTEMPTING TO CHANGE THE LOG/ROCK SET):

1. Place fireplace on a flat, level surface (FIG 1).
2. Remove 3 screws located on each side of glass face of fireplace (FIG 2 and FIG 3).
3. Remove screws that attach the log/rock set to the front of fireplace (FIG 4).
4. Replace with the desired set (log/rock) and re-assemble new set by inserting and tightening screws (FIG 5).
5. Re-assemble glass face to fireplace by inserting and tightening screws on both side of glass face (FIG 6).



FIG 1

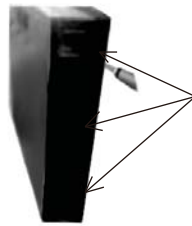

FIG 2



FIG 3



FIG 4

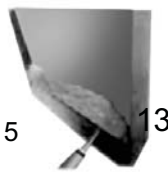

FIG 5

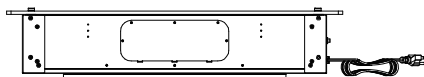

FIG 6

## REPLACING THE LIGHT BULBS

This fireplace uses 2 clear 110 Volt, 40 Watt, E-12 socket base light bulbs (small base, chandelier candle type bulbs). The access plate is located on the bottom of the unit. For convenience, if one of the light bulbs burns out, it may be easier to replace both of the light bulbs at the same time.

**WARNING:** Do not exceed 40 Watts per bulb. Use of higher rated bulbs may result in a fire, causing property damage, personal injury or loss of life.



Bottom view

FIG 1

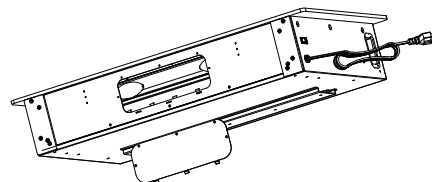

Bottom view

FIG 2

1. Turn off the power to the unit, and unplug it from the electrical outlet.
2. Let the fireplace cool if it has been operating.
3. Look for the access plate with the gold printing on the bottom of the unit.
4. Remove the 5 screws holding the access plate in position (FIG 1). Once you have removed the 5 screws, lift the access plate so the 3 positioning tabs come free of their slots. Once you have removed the access plate you can see and access the two 40 watt chandelier bulbs (FIG 2).

## MAINTENANCE



### **Preparation for Maintenance**

**WARNING:** Always disconnect the power and allow the electric fireplace to cool completely before performing any cleaning, maintenance or relocation of this electric fireplace. Turn all controls to OFF and remove plug from outlet or turn off the house circuit breaker to electric fireplace receptacle.

Most halogen light bulbs are rated to last approximately 1800 hours. Like all light bulbs, halogen bulbs require periodic replacement. When the bulbs in your unit have burned out you will notice one or more of following:

#### **Common Observed Problems:**

- **There is no flame**
- **Flame is dim or dark in certain areas**
- **Flame is not moving or glowing**
- **Ember bed is dim or dark in certain areas**

Your fireplace unit must be opened in order to replace the light bulbs. To reduce the number of times you need to open the unit, replace all bulbs at the same time if they are close to the end of their rated life.



**WARNING:** Do not install replacement bulbs that exceed specified maximum watts.



**WARNING:** The halogen light bulbs in your unit can become extremely hot. Allow at least 10 minutes between turning off the heater and removing the light bulbs to avoid accidental burns.



## TROUBLE SHOOTING

**WARNING:** Turn off the appliance, unplug and let cool for at least 10 minutes before attempting to service. Only a qualified professional should attempt to service or repair the appliance.

PROBLEM	POSSIBLE CAUSE	CORRECTIVE ACTION
1.No power, no indicator lights	Insert was not plugged in	Make sure that power cord is plugged into 120V outlet
2.No power, no indicator lights	No power at outlet	Check circuit breaker or fuse
3.Power indicator lights come on, logs will not glow and no flame effect	Broken or burned out light bulbs	Follow instructions for replacing light bulbs
4.Log glow, but no flame	Flame spinner disconnected	Call customer service for instructions
5.Flame and logs glow, but no heat	Heater switch is off	Push heater button. Indicator light will come on
6.Heater and /or flame turn off while operating	Timer function may been on	Push On/Off button to reset