

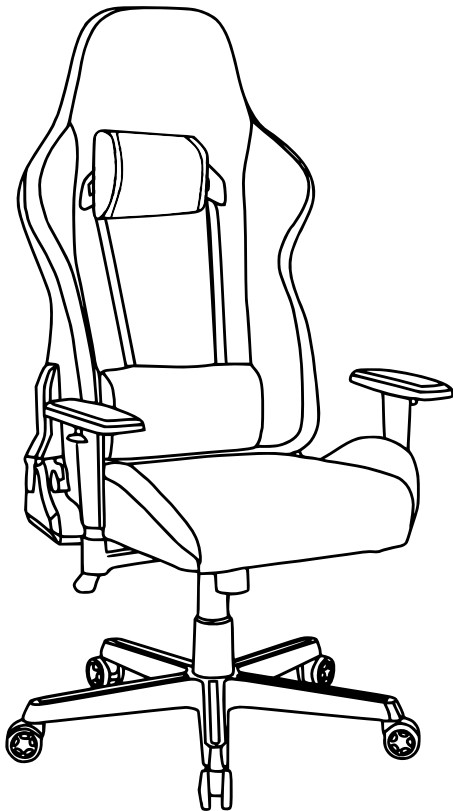

GAMING CHAIRS

ASSEMBLY INSTRUCTIONS

Thank you for purchasing our product





SERIES	MODELS
Echo	TSF44
	TSF71
Lux	TS42
GG	TS51
Geo	TS70
ProGamer2	TS43
	TS90
	TS92
GameMaster	TS83
Cow Print	TS85
Pastel	TS86











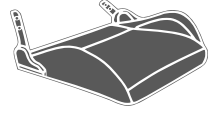

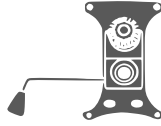
(General representation of our gaming chairs. The styles, materials, colors and features vary with series and models)

REV.ZK-7062-1222





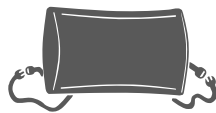





<p>Do a quick inventory of all the parts and hardware listed below</p> 	<p>Missing, damaged and defective parts can be replaced at no cost to you. Please refer to the last pages on this manual.</p> 	<p>The replacement parts service is limited to the 48 contiguous United States. If you reside in AK, HI, PR, U.S. territories or other countries, please contact the supplier from where the unit was purchased.</p> 
--	---	--

MAIN PARTS LIST (General representation; the styles, materials, colors and features vary from models)

A x1	Backrest 	B x1	Seat  <small>* Please see below for important note about the brackets.</small>	C x1	5-Leg star base  <small>TS51 & TS83 come with metal base, the rest use nylon bases</small>	D x1	Mechanism 	E x1	Lift cylinder 
F x5	Caster 	G-R x1	Right armrest  <small>Sitting on the chair, not looking at it</small>	G-L x1	Left armrest 	H x1 Set	Lift cover, Set of 3 cones 	I-L x1	Left cover for seat bracket 
I-R x1	Right cover for seat bracket 	J-L x1	Lumbar pillow  <small>TS85: No straps. TS42: Heart shaped with no straps.</small>		J-N x1	Neck pillow  <small>TSF71 doesn't include neck pillow.</small>			

* The left metal bracket on the seat is loose, while the right is stiff and can only move until the chair is assembled.

HARDWARE LIST AND INCLUDED TOOLS

PART #	QTY	SIZE / DESCRIPTION	USE IN	
K	1	M5 Allen wrench	Steps 1, 2, 5, 6	 M5
L	4	M8x20	Mechanism to seat	
M	12	M8x25	Armrests to seat, seat to backrest	
N	2	M5x12	Covers to brackets	
O	16	Ø12, Ø9 O-Ring	Mechanism, armrests, brackets	
P	16	Ø17, Ø9 Washer	Mechanism, armrests, brackets	
Q	4	Ø25, Ø9 Felt gasket	Mechanism	
R	4	Ø14, Ø11 Hole cover	Bracket and seat side covers	

BEFORE YOU START THE ASSEMBLY, PLEASE READ THE FOLLOWING TIPS AND WARNINGS.

- Do not discard this manual or any of the packaging material until the unit has been completely assembled.



- If during assembly you find an issue or need clarification, please contact our Customer Service for assistance. Please refer to the last pages on this manual.



- On each step read the instructions thoroughly and analyze the illustrations before proceeding to do the assembly.
- Follow the instructions step by step and do not skip any unless our Customer Service advises it is OK to do so.



- Make sure you understand which hardware will be used on each step. Using the wrong size of screw, bolt or pin might strip the threads or cause damage to the part in which it is being used.

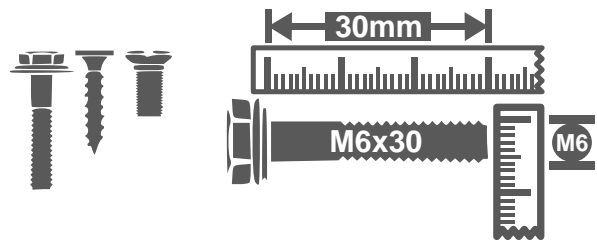

- To avoid misalignments, always leave the screws loose and tighten them until all pieces are positioned correctly.

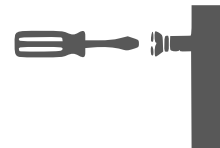

- Do not overtighten or force the screws as they might break, strip, damage the threads of the holes or get stuck inside the part.

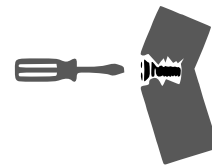

- If the hole seems too small for the screw, make sure you are using the correct size of screw and/or that you are installing it in the correct hole.





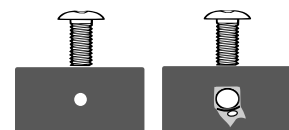

- Sometimes the fabric or material might cover partially or entirely the screw hole, making the hole appear to be too small.



ASSEMBLY STEPS

STEP 1

Hardware

L		4	Pcs
O		4	Pcs
P		4	Pcs
Q		4	Pcs
K			

Flip over the seat **B** and place the felt gaskets **Q** over the innermost holes in the middle and back of the frame.



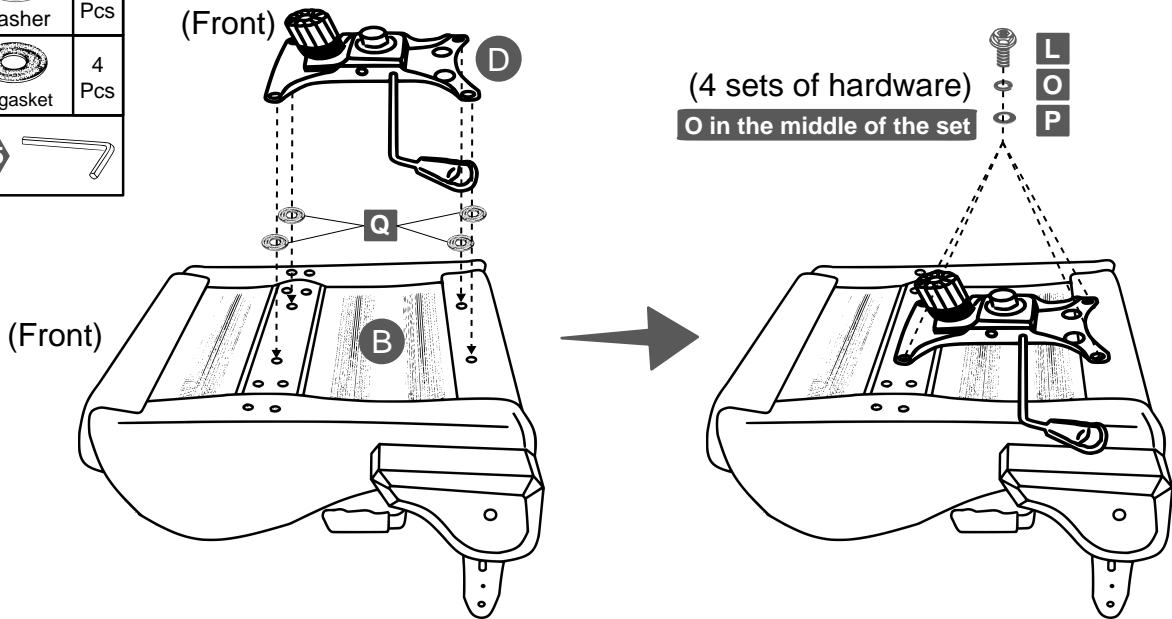

Place the mechanism **D** over the felt gaskets, making sure its tension knob faces towards the FRONT.

Secure the mechanism to the seat with screws **L**, O-rings **O** and washers **P**, making sure the O-ring go in the middle of the hardware set.



STEP 2

Hardware

M		8	Pcs
O		8	Pcs
P		8	Pcs
K			

Assemble the armrests **G-L**, **G-R** to the seat **B** in their respective sides with screws **M**, O-rings **O** and washers **P**, making sure the O-ring go in the middle of the hardware set.

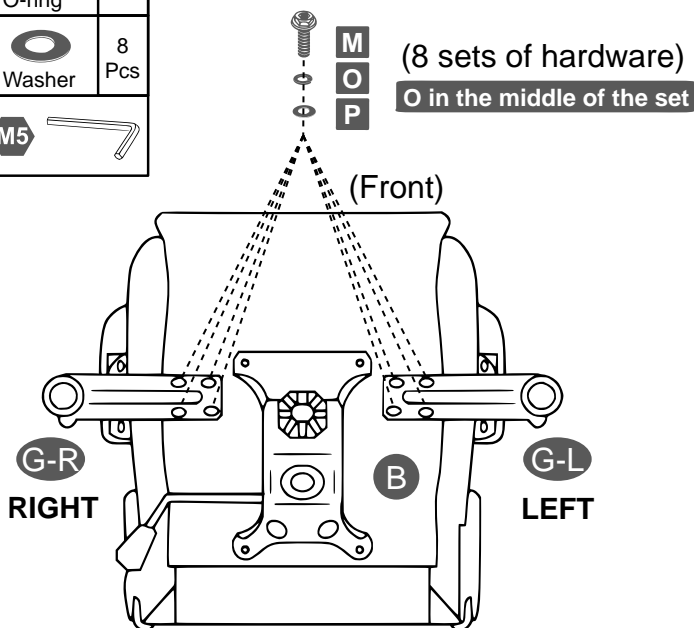

STEP 3

Insert the casters **F** into the legs of the base **C** using pressure, then place the lift cylinder **E** in the middle of the base and cover it with **H**.

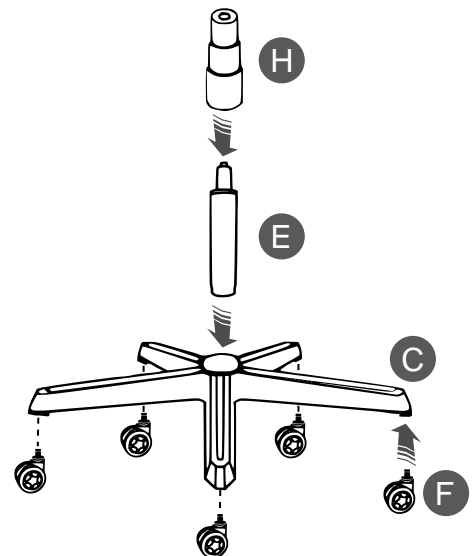

STEP 4

Join the base parts to the seat making sure the tip of the lift **E** enters correctly into the hole of the mechanism **D**.

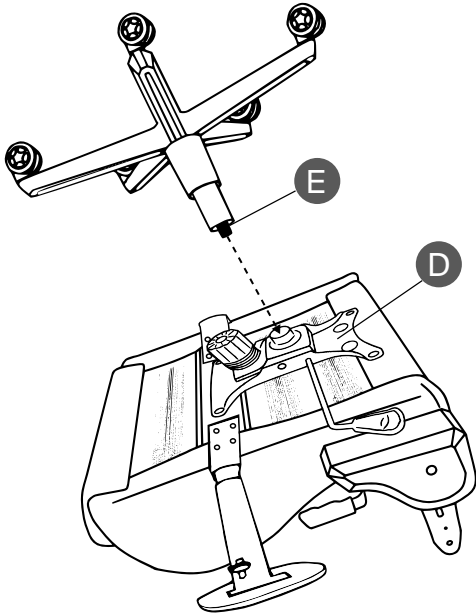

STEP 5

Hardware

M		4 Pcs
O		4 Pcs
P		4 Pcs
K		

Assemble the backrest **A** to the metal brackets on the seat **B** with screws **M**, O-rings **O** and washers **P**, making sure the O-ring go in the middle of the hardware set.

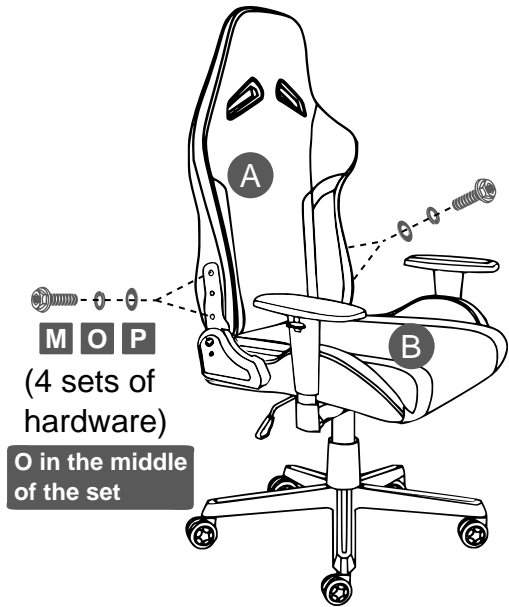
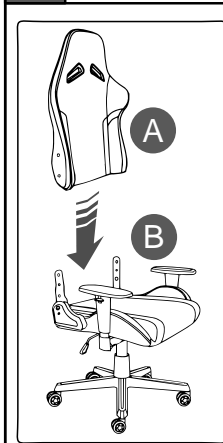

STEP 6

Hardware

N		2 Pcs
R		4 Pcs
K		

Attach the covers **I-L**, **I-R** to the seat brackets on their respective sides with screws **N**, then cover the screw holes with **R**.

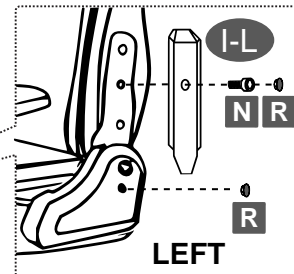
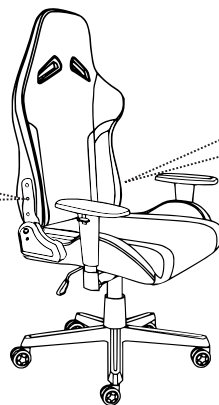
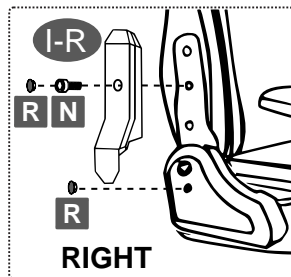

STEP 7

Attach the pillows **J-L** (lumbar) and **J-N** (neck) to the backrest **A** by fastening the strap buckles from behind.

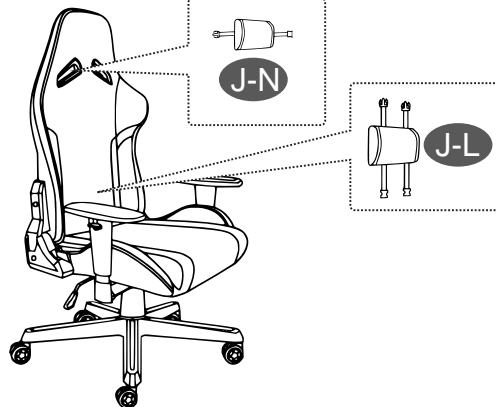
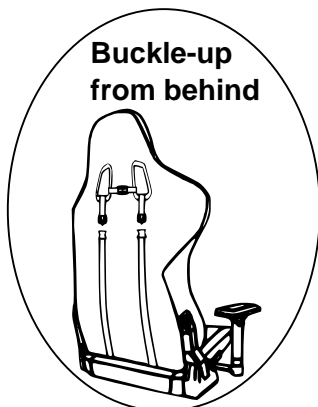

NOTES:

1. The lumbar pillows on TS42 and TS85 have no straps.
2. TSF71 doesn't include a neck pillow.

CHAIR'S FUNCTIONS

- ① To raise or lower the chair's height, pull UP the lever that is under the seat on the right side. The chair goes down while sitting on it, or up if you lift your body.
- ② The chair also tilts by pulling OUT the same lever to unlock, but please note that unlike regular chairs, gaming chairs have their balance centered farther back, so the chair feels harder to tilt.
- ③ The mechanism under the seat has a tension knob at the front that you can turn and it will make the tilting feel little easier, but please refer to the notes in point 2 about the tilting.
- ④ To recline the backrest to a specific angle, pull UP the short lever located on the right side of the seat, recline and then release the lever to lock into the desired position.
- ⚠ **WARNING:** For your safety, the tilt's function ② should be in the LOCKED (IN) position prior to use the backrest reclining function ④.
- ⑤ To adjust the armrest height, press the button that is on the outside of the armrest and release it once the desired height is reached. Some models have additional functions for the arm pads such as turning and sliding.

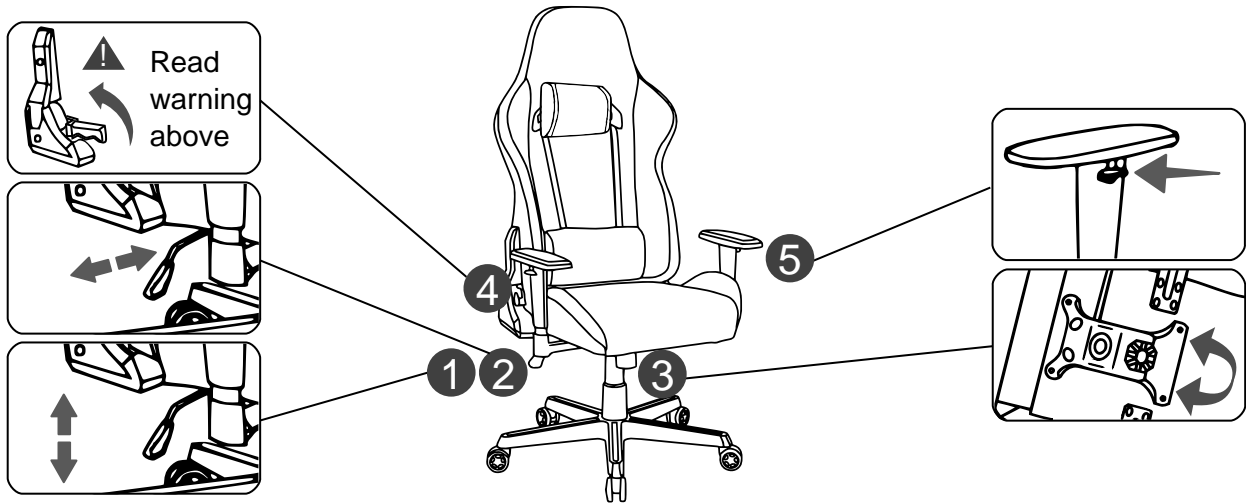

WEIGHT LIMIT AND WARNINGS

- Do not exceed the indicated weight limit.
- Do not stand up on the chair or use it as ladder.
- Only one person at a time can sit on the chair.
- Do not use the chair if parts are bent, damaged, or if screws are loose or missing.
- Unlike regular chairs, gaming chairs have their balance centered farther back, so do not sit near the edge of the seat to avoid going beyond your balance point and falling off the chair, and always sit properly.
- If small children are sitting on the chair, keep close observation on them.
- Do not allow small children to play with the chair.
- Not paying attention to these warnings could result in injuries.

LIMIT	MODELS
250 Lbs	TS43
	TS70
	TS90
	TS92
	TSF44 TSF71
300 Lbs	TS42
	TS51
	TS83
	TS85 TS86

CARE AND MAINTENANCE

- To clean the chair it is recommended to use a soft cloth lightly damped in a solution of smooth soap and water, then dry with a clean towel.
- Do not use solvents or abrasive materials to clean any part of the chair.
- Before using a cleaning agent, test on a small hidden area of the chair, like underneath the seat.
- Do not expose the product to direct sunlight or to extreme environmental conditions.
- Inspect the chair completely every 4 months and make sure that all screws are tighten. Do not use if parts are bent, damaged, or if screws are loose or missing.

TECHNI SPORT CHAIR WARRANTY



GAMING CHAIR: 2-YEAR WARRANTY
INTERNAL METAL FRAME*: LIFETIME WARRANTY



RTA Products, LLC has warranted the Techni Sport products to the original purchaser who acquired a new product from RTA Products or its authorized re-sellers of the product against defects in material or workmanship.

This warranty is expressly limited to the repair or replacement (at its option) of defective product components or materials as a result of a defect in materials or workmanship. This warranty is limited to merchandise purchased in the Continental United States, excludes AK, HI and PR. No assembly labor is included. The word "defects" as used in this warranty, is defined as imperfections that impair the utility of the product.

Replacement Parts under Warranty for International / AK-HI-PR orders : RTA Products will replace the part free of charge, while customer is responsible for shipping costs plus any International local taxes or duties. Warranty for International orders - replacement parts: buyer is responsible for shipping costs plus any local taxes or duties.

This warranty applies under conditions of normal use, but does not apply to defects that result from intentional damage, wear & tear, negligence, unreasonable use or exposure.

Internal metal frame*: Refers to the internal metal steel structure of the seat and back only.

Liability for consequential damages is excluded to the extent exclusion is permitted by law. This warranty gives you specific legal rights, and you may have other rights that vary from State to State.

RTA Products does not warrant: a) natural variations in character marks b) changes in surface finishes due to aging or exposure to light c) marks, scars, or wrinkles occurring naturally in leather d) failure resulting from normal wear and tear e) the matching of colors, grains, or textures of natural materials f) the colorfastness or the matching of textiles, including an exact match to cuttings or to swatch cards g) damage, marking, or staining of veneer surfaces due to contact with rubber or similar compounds, damage from sharp objects or imprinting from writing instruments, or prolonged exposure to direct sunlight h) we do not warrant products that are exposed to extreme environmental conditions or that have been subject to improper storage.

RTA Products shall not be liable for loss of time, inconvenience, commercial loss, or incidental or consequential damages.

Any modification to the original product voids the warranty. We do not warrant the performance of the product when used in combination with other than original products.

This product has been designed for and is intended for office, home-office and gaming use only. This warranty is Original Purchaser's sole remedy for product defects, and this warranty does not extend to any product, or damage to any product, caused by or attributed to abuse or misuse, products used for commercial or rental purposes, use modifications of, or attachments to the product, and products or parts not used, maintained, or extended here under is in lieu of any and all other warranties, express or implied, including without limitations any implied warranty or merchant ability or of fitness for a particular purpose. Report any defects to RTA Products, LLC together with your sales receipt or other proof of purchase. If the chair is defective within the terms of the warranty, RTA Products, LLC will furnish a replacement chair (at its option) at no cost of equal or similar value and design.

RTA Products will advise you of the procedure to follow in making warranty claims. The following are the procedures for warranty claims:

a) Contact us directly via e-mail to support@rtaproducts.com Please provide your original ORDER#.

Explain in your e-mail the issue/s you have with our product. Please allow up to 24 hrs for our Customer Support team to reply. If your matter is urgent and requires immediate attention, you are welcome to call us between Monday - Friday - from 9am-4pm (Eastern Standard) at 866-782-5520. Please be advised that you are still required to provide all details in writing via e-mail.

b) If we determine that replacement will remedy the situation, and in order to determine the extent or the cause of the defect, purchaser will need to send the part in question at purchaser's expense. Once we receive the part, we will examine it and determine whether the claim is valid (or not), and then proceed to send the replacement. We will ship the replacement at our expense.



Your satisfaction is very important to us. Our Support agents can help you with any issues you may have, please feel free to contact us with any questions you have about our products, or to request replacement parts.

FOR ADDITIONAL INFORMATION PLUS HELP OPTIONS

VISIT: WWW.TECHNISPORTUSA.COM
 AND CLICK ON INFO/SUPPORT

Scan the following QR Code to send us a message:



EMAIL US:

support@technisportusa.com

To request replacement parts, email us with the model number of the product, the part number or letter of the requested part, and proof of purchase.

