

Installation and Operation Instructions

ELECTRIC FIREPLACE

CAM35WMEF

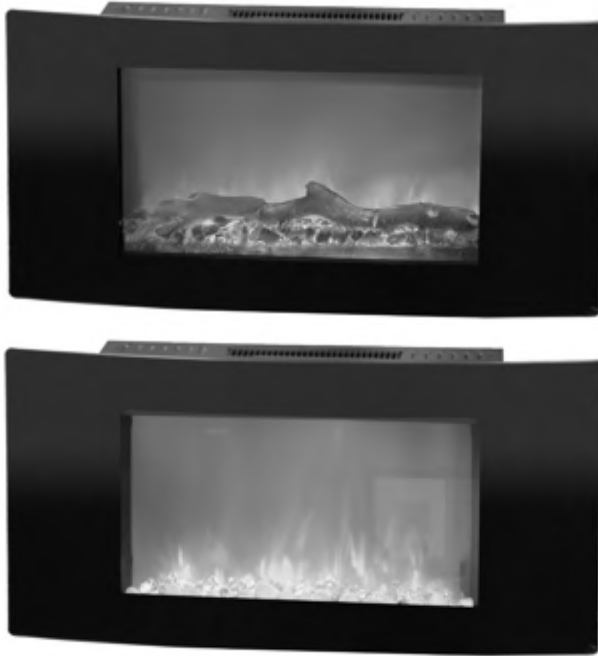

READ & SAVE THESE INSTRUCTIONS

Carefully read and review before assembling, installing, operating or maintaining this product. Observe all safety instructions and information.

FAILURE TO FOLLOW WARNINGS & OPERATIONAL INSTRUCTIONS CONTAINED IN THIS MANUAL CAN RESULT IN PROPERTY DAMAGE OR PERSONAL INJURY.



Read these instructions completely before beginning installation. Failure to follow them could cause a heater malfunction resulting in serious injury and/or property damage.



WARNING: All electric heaters have hot and arcing or sparking parts inside. Do not use it in areas where gasoline, paint or flammable liquids are present.



WARNING: This electric fireplace is tested and listed for use only with the optional accessories listed in these instructions. Use of optional accessories not specifically tested for this electric fireplace could void the heater warranty and/or result in a safety hazard.

TABLE OF CONTENTS

Important Safety Instructions	4-6
Listing Approvals	7
Product Dimensions	8
Locating Fireplace	9
Unpacking and Testing Fireplace	10
Grounding Instructions	10
Installation	11-12
Finishing Ckecklist	13
Operating Instructions	13-14
Replacing The Rock/Log Set	15
Troubleshooting	16

IMPORTANT SAFETY INSTRUCTIONS

1. Prior to plugging your heater into an electrical outlet, verify that the house circuit breakers for the outlet are on.
2. The heater may emit a slight, harmless odor when first used. This odor is normal and it is caused by the initial heating of internal heater elements and will not occur again.
3. If your heater does not emit heat, consult the operation section of this manual for further information.
4. Use with a CSA or UL certified surge protector.



SA1965

CAUTION:
RISK OF ELECTRIC SHOCK
DO NOT OPEN
NO USER-SERVICEABLE PARTS INSIDE
HIGH TEMPERATURE



SA1965

KEEP ELECTRICAL CORDS, DRAPERY AND OTHER FURNISHINGS AT LEAST 3 FEET (0.9m) FROM THE FRONT AND SIDES OF THE HEATER.

⚠ CAUTION: High temperature, risk of fire.
Keep electrical cords, drapery, furnishings, and other combustibles at least 3 feet (0.9m) from the front of the heater and away from the side and rear.

⚠ WARNING: Servicing should be done only while the heater is disconnected from the power supply circuit.

IMPORTANT SAFETY INSTRUCTIONS

When using this electric fireplace, basic precautions should always be followed to reduce the risk of fire, electric shock and injury to persons, including the following:

1. Read all instructions before using this electric fireplace.
2. This heater is hot when in use. To avoid burns, do not let bare skin touch hot surfaces. Keep combustible materials, such as furniture, pillows, bedding, papers, clothes and curtains at least 3 feet (0.9m) from front of heater and keep them away from sides and rear
3. Extreme caution is necessary when any heater is used by or near children and whenever the heater is left operating and unattended.
4. Always unplug electric fireplace when not in use.
5. Do not operate this electric fireplace with a damaged cord or plug or after heater malfunctions, has been dropped or damaged in any way. Return heater to authorized service facility for examination, electrical or mechanical adjustment or repair.
6. Do not use this electric fireplace outdoors.
7. This electric fireplace is not intended for use in bathrooms, laundry areas and similar indoor locations. Never locate electric fireplace where it may fall into a bathtub or other water container.
8. Do not run cord under carpeting. Do not cover cord with throw rugs, runners or the like. Arrange cord away from traffic area and where it will not be tripped over.
9. To disconnect electric fireplace, turn controls to "OFF" before removing plug from outlet.
10. Connect to properly grounded outlets only.

IMPORTANT SAFETY INSTRUCTIONS

11. Do not insert or allow foreign objects to enter any ventilation or exhaust opening as this may cause an electric shock or fire or damage the heater.
12. To prevent possible fire, do not block air intakes in any manner. Do not use on soft surfaces, like a bed, where openings may become blocked.
13. The electric fireplace has hot and arcing or sparking parts inside. Do not use it in areas where gasoline, paint or flammable liquids are used or stored.
14. Use this electric fireplace only as described in this manual. Any other use not recommended by the manufacturer may cause fire, electric shock or injury to persons.
15. Always use properly grounded fused and polarized outlets.
16. Always use ground fault protection where required by electrical codes.
17. Always disconnect power before performing any cleaning, maintenance or relocation of heater.
18. To prevent a possible fire, do not burn wood or other materials in this electric fireplace.
19. To prevent electric shock or fire, always hire a certified electrician should new circuits or outlets be required.
20. When transporting or storing this electric fireplace, keep in a dry place free from excessive vibration and store as to avoid damage.
21. Always plug heaters directly into a wall outlet/receptacle. Never use with an extension cord or relocatable power tap (outlet/power strip)

SAVE THESE INSTRUCTIONS!

LISTING APPROVALS

This heater has been tested in accordance with the CSA Standards.

Model Number:	X35WMEF
Description:	Wall Mount Electric Fireplace
Voltage:	120V AC ,60Hz
Watts:	MAX 1350W
Length:	35.0"
Height:	17.7"
Depth:	5.5"

PRODUCT DIMENSIONS

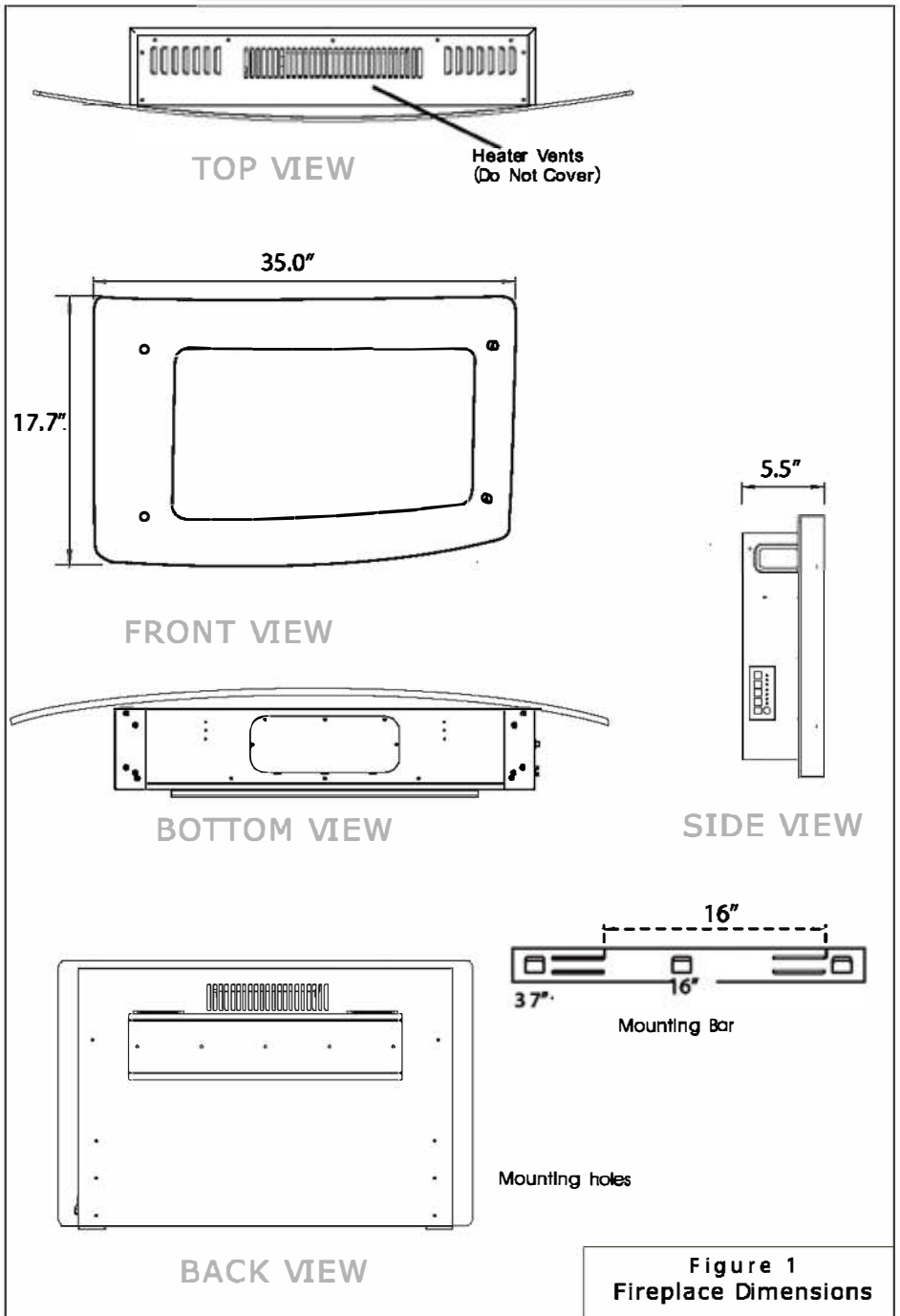

LOCATING FIREPLACE



WARNING: Due to high temperatures, this electric fireplace should be located out of traffic. Keep combustible materials such as furniture, pillows, bedding, papers, clothes and curtains at least 3 feet (0.9m) from the front of the heater.



WARNING: Never locate this electric fireplace where it may fall into a bathtub or other water container.



CAUTION: Do not expose the electric fireplace to the elements (such as rain, etc.)



CAUTION: Wear gloves and safety glasses for protection during installation and maintenance.



WARNING: To prevent contact with sagging or loose insulation, the electric fireplace must not be installed against vapor barrier or exposed insulation. Localized overheating could occur and a fire could result.

UNPACKING AND TESTING FIREPLACE

Carefully remove the unit from the box. Prior to installing the unit, test to make sure the unit operates properly. To do this, plug the unit's power supply cord into a conveniently located 120 -Volt grounded outlet.

GROUNDING INSTRUCTIONS

This insert is for use on 120 Volts. The cord has a plug as shown in (A) of Figure 2 given below. An adapter as shown in (C) is available for connecting three-blade grounding-type plugs to two-slot receptacles. The green grounding plug extending from the adapter must be connected to a permanent ground such as a properly grounded outlet box. The adapter should not be used if a three-slot grounded receptacle is available.

To disconnect heater, turn controls to off, then remove plug from outlet.

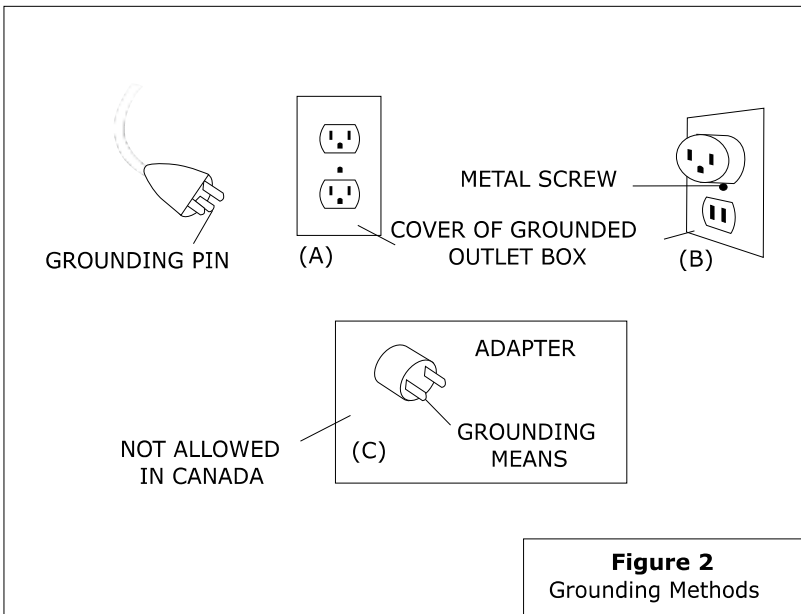

INSTALLATION



WARNING: RISK OF FIRE! The power cord must not be pinched or against a sharp edge. Secure cord to avoid tripping or snagging to reduce risk of fire, electric shock or personal injury. Do not run cord under carpeting. Do not cover cord with throw rugs, runner or the like. Arrange cord away from traffic area and where it will not be tripped over.



WARNING: RISK OF FIRE! To prevent a possible fire, do not block air intake or exhaust in any manner. Do not use on soft surfaces where openings may become blocked.



WARNING: RISK OF FIRE! Do not blow or place insulation against the fireplace.



WARNING: If the information in these instructions is not followed exactly, a fire or explosion may result causing property damage, personal injury or death. Do not store or use gasoline or other flammable vapors in the vicinity of this or any other heater.

INSTALLATION

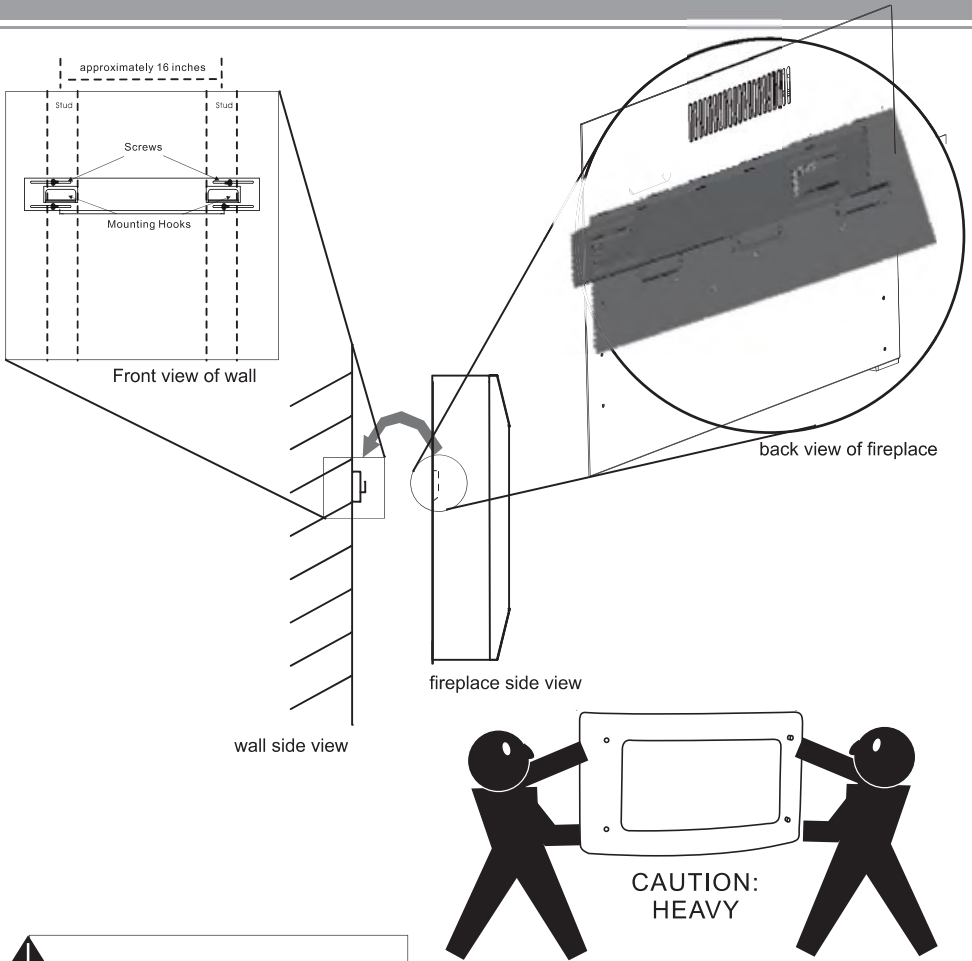

! This fireplace must be mounted on a wall with a height above the floor between 0.5M (1.64 Feet) and 2.5M (8.2 Feet).

! **WARNING:** Heater vents (see Figure 1, page 8) on this electric fireplace cannot, in any way, be covered as it may create a fire hazard.

! Due to the many different materials used on different walls, it is highly recommended that you consult your local hardware store to determine what type of mounting screws are needed before you install this fireplace onto the wall.

Figure 3
Grounding Methods

FINISHING CHECKLIST

- > Power supply service must be completed prior to finishing to avoid reconstruction.
- > Heater vents and air openings cannot be covered in any circumstances.

OPERATING INSTRUCTIONS

Once the unit has been properly connected to a grounded electrical outlet, it is ready to operate.

Note: Ensure the house circuit breakers for the power supply are turned on.

Main Power Switch:

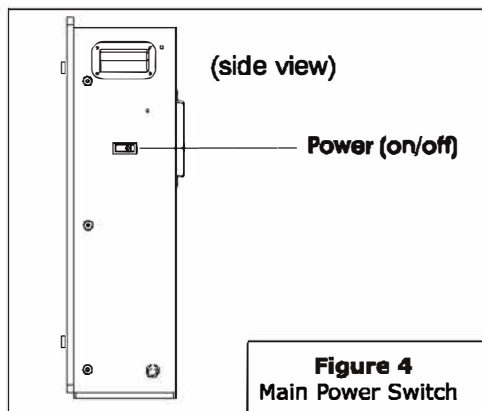

The Main Power Switch is located on the right side of the unit. Figure 4 illustrates the location of the switch. The "I" indicates ON and "O" indicates OFF. Push the switch to "I" to turn on the unit and the flame effect. The red LED Indicator will be turned on.

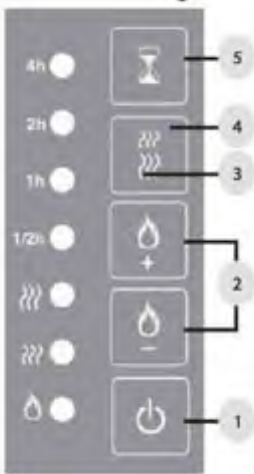

OPERATING INSTRUCTIONS

The manual controls are located on the left side of the fireplace.
You have the following controls:



1. Power ON/OFF: Power to the unit
 2. Flame brightness controls: Allows you to adjust the flame to suit your mood. Press  to increase flame brightness and  to decrease flame brightness. You must press the  button several times to see the full flame effect.
 3. Low heat: 700 watts
 4. High heat: 1400 watts
- Please note: The heater touchpanel control must be touched 2 times to achieve high heat.
5. Heater Timer: Allows you to leave your heater on while you sleep with an automatic timer for shut off. You can set your heater to be on for 1/2 hour increments starting at a 1/2 hour up to a maximum of 7-1/2 hours – press once for each 1/2 hour increment. After you reach 7-1/2 hours the next press will shut off the feature.

OPERATING BY REMOTE CONTROL





1. Plug in your electric fireplace.
2. Make sure the unit's Main Power ON/OFF Switch is at the ON position! The remote control will NOT work if the Main Power Switch is at the OFF position.
3. When operating the remote control, it must be pointed towards the front of the unit.
4. The ON/OFF button at the below right of the remote is the main ON/OFF power button (Figure 5). Pressing this button activates the power to the unit.
5. To activate the heater, press the  button. Press and release the button to cycle through LO, HI and OFF.
6. To adjust the flame height and ember bed brightness, press the " " or " " buttons. To increase the flame height and ember bed brightness, press the " " button, to decrease the flame height and ember bed brightness, press the " " button. There are five levels of flame effects.
7. To turn off the fireplace, press the ON/OFF button once. NOTICE: This remote control must remain within 8 meters or 26 feet of the fireplace to be effective.



Figure 5
Remote Control For
Electric Fireplace

Replacing The Rock/Log Set

TO CHANGE LOG/ROCK SET (NOTE: MAKE SURE FIREPLACE IS TURNED OFF AND HAS BEEN UNPLUGGED FROM ELECTRICAL OUTLET BEFORE ATTEMPTING TO CHANGE THE LOG/ROCK SET):

1. Place fireplace on a flat, level surface (FIG 1).
2. Remove 3 screws located on each side of glass face of fireplace (FIG 2 and FIG 3).
3. Remove screws that attach the log/rock set to the front of fireplace (FIG 4).
4. Replace with the desired set (log/rock) and re-assemble new set by inserting and tightening screws(FIG 5).
5. Re-assemble glass face to fireplace by inserting and tightening screws on both side of glass face (FIG 6).



FIG 1



FIG 2



FIG 3



FIG 4



FIG 5



FIG 6

TROUBLESHOOTING



WARNING: Turn off the fireplace completely and let cool before servicing.

OBSERVED PROBLEM	POSSIBLE CAUSE	REMEDY
No warm air is coming out of the heater. Heat doesn't turn on when it is set to Low setting.	1. Room temperature is higher than the heater setting (if it is set to LO or MED)	1. Set heater to a higher temperature setting (MED or HI)
Fireplace turns off and will not turn on	1. Fireplace has overheated and safety device has caused the thermal switch to disconnect 2. House circuit breaker has tripped	1. Unplug the unit, allow heater to cool for 10 minutes, then plug it back in 2. Reset house circuit breaker
Fireplace will not come on when switch is flipped to ON	1. Fireplace is not plugged into an electrical outlet 2. Fireplace has overheated and safety device has caused the thermal switch to disconnect	1. Check plug and plug it in 2. Unplug the unit, allow heater to cool for 10 minutes, then plug it back in
Remote control does not work	1. Low batteries	1. Replace AAA batteries in remote control The remote takes 2 x AAA batteries