

Shower & Spa System Solutions

Innovative high quality underlayment systems for tiled interior wet rooms

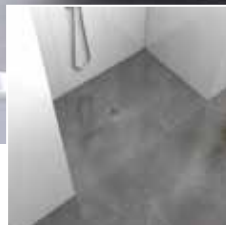

Your local wedi distributor:





From Emsdetten in Germany and Europe to North America wedi has close ties to the world of building and renovation. Thanks to our extensive presence, we are always in the position to react quickly and without complications to the requirements of our customers. A large number of notable companies in Germany and abroad benefit from the innovative development of our product systems, partly because we know the needs of our contractors like the back of our hands. Wherever you are in the building industry, we are right by your side with expertise, performance and passion. Leading you to success. Now proudly producing in the USA in Batavia, Illinois. We also service our North American customers from our two logistics centers in Batavia and in Sacramento, California.



100 % waterproof throughout product & installation system



Complete range of shower systems and accessories, easily customizable



Fast and clean modular installation processes



Tested, certified and proven product systems



wedi Warranty – unique coverage and programs for 10, 15 & 20 year warranties



Ready to tile upon installation – same day

wedi Shower System Solutions

wedi Waterproof Shower Systems offer reliable, cost-efficient solutions for constructing 100% waterproof and mold proof showers and are easy to install.

- Fundo Primo Shower Kit/Fundo Riolito neo Shower Kit
- Fundo Primo, Shower Base and Accessories
- Fundo Ligno, Barrier Free Shower Base
- Fundo Riolito neo, Shower Base with linear drain
- Shower Base Extensions
- Fundo Riolito Discreto, Tileable vertical drain cover system

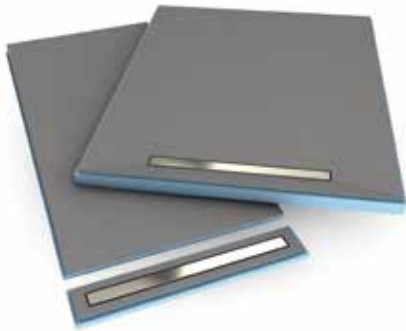

wedi Building Panel

wedi Building Panels are the ultimate and complete wet room tile backer board and often used within the range of wedi shower systems as well as on walls, floors, countertops and many more applications.

- For Shower, Tub & Steam Room Walls and Ceilings, Separate Steam Rooms & Showers (Building Panel Vapor 85)
- Over Wood and Concrete Subfloors – With or Without Floor Warming Systems
- In countertop and backsplash installations
- Constructing Individual Tileable Furniture

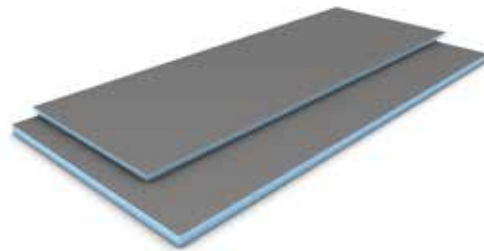

wedi Prefabricated Modules

wedi Prefabricated Modules open up a whole new world of design possibilities for showers, wet areas and baths.

- Curbs
- Recessed Niches
- Benches and Seats
- Sloped Shower Ramps

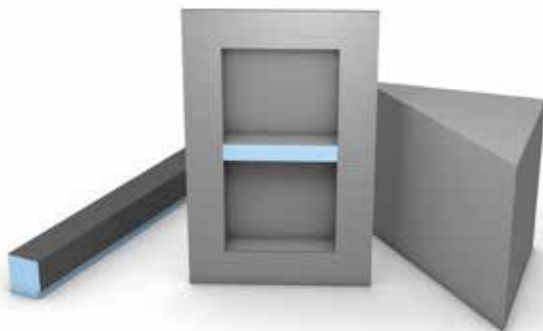

Installation Accessories & Tools

wedi Installation Accessories & Tools offer additional products you need for the installation and guarantee maximum safety and easy handling.

- Joint Sealant
- wedi waterproofing sheet membranes and tapes
- Fastener Systems (washer and screws)



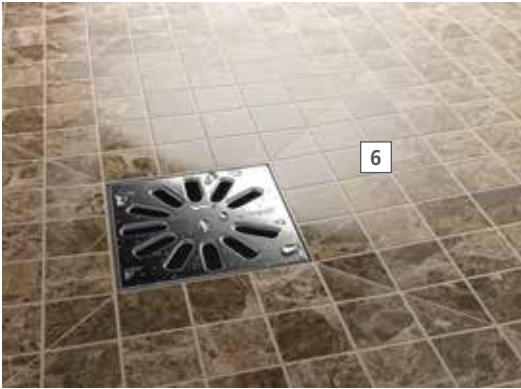

01 wedi Fundo Primo®
The original wedi Fundo: Robust, pre sloped, waterproof, shower floor bases with 4" x 4" drain cover. Customizable on site. Often installed on substrates and used with wedi curbs.

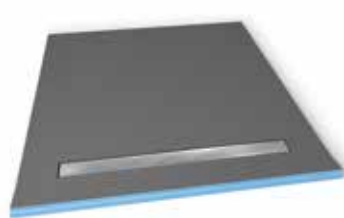

02 wedi Fundo Riolito® neo/
Riolito® neo Modular
Fully factory integrated linear drainage. Models include one-way, two-way and four-way slope designs.

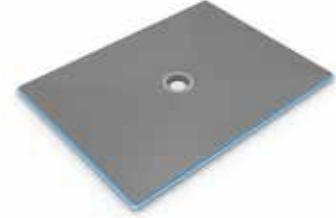

03 wedi Fundo Ligno®
Our newest Fundo model: Floor level 3/4" profile designed especially for suspended wood subfloors. Like all wedi Shower Bases it is pre sloped, and waterproof. Comes with 4" x 4" drain cover. Customizable on site.



04 wedi Fundo Discreto®
Wall drain module for integration in seats or false walls. Installs over select Riolito neo linear drain models. Cover is tileable on one side and polished stainless steel on reverse side.

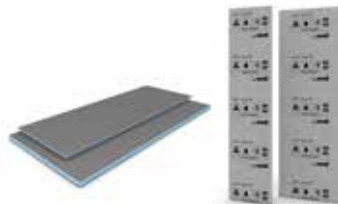

05 wedi Building Panels and Vapor 85
Perfect waterproof tile substrate for practically any wall, floor, ceiling application in interior wet areas. The wedi Vapor 85 Building Panel is used for Steam Rooms and Steam Showers.



06 wedi Fundo Primo® Drains Covers
Special cover plate designs available. Each standar Drain Cover Set comes with an easy to use compression fit black ABS drain.



07 wedi Shower Benches
 Prefabricated, slightly sloped bench options or simply built on site to fit using wedi 2" or 1 1/2" Building Panel.



08 wedi Wall Mounted Triangle Seat
 Suspended seat solution, equipped with mounting bracket system for installation into existing framing.



09 wedi Niches
 The perfect fit for all shower necessities.

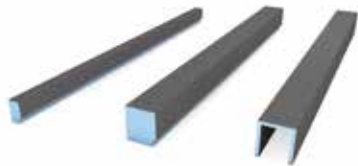

10 wedi Curbs
For shower entry design where safe and sound transitions are required.

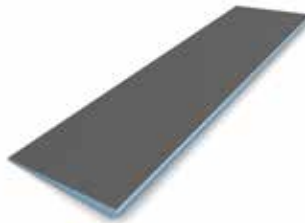

11 wedi Sloped Shower Ramps
Where wheelchair accessible or ADA compliant entries are required.

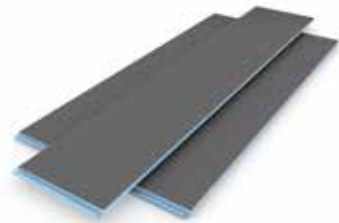

12 wedi Shower Base Extension
Extend any wedi shower floor base type using pre-sloped extension modules featuring pre-made connections to any base.



wedi Fundo Primo® Kit

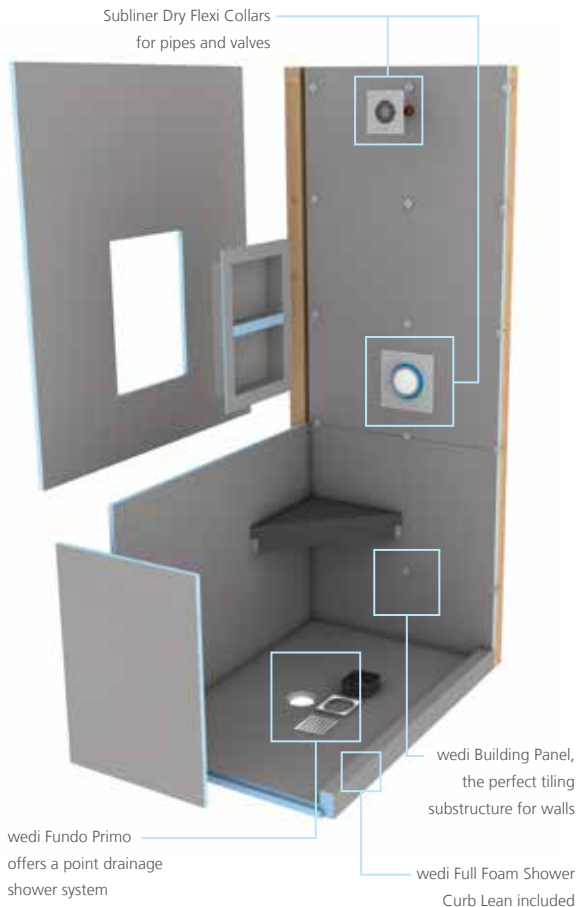

wedi Fundo® Shower Kits

- Available as wedi Fundo Primo Kit (point drain) and Fundo Riolito neo Kit (linear drain)
- Easy to install and blending the traditional values of design flexibility and robustness while offering the added benefits that come with state of the art material and manufacturing technologies
- No more presloping, pan liner cracks or membrane pin holes, clogged drain weepholes and mold growth
- Reducing the traditional installation time and down times for a full shower floor preparation for tiling from 2 – 3 days to now 30 minutes
- Entire System is 100% waterproof and moldproof
- Very low weight, but extremely durable





The total shower solution

- All you need to build a shower system ready for tile in one Kit box – selectively with point or linear drain
- One price for all you need for the shower structure- easily budgeted for cost and installation time
- All you need in a safe and protected box for simple and fast logistics and handling
- For a safe modular installation with option to field modify system components for custom tiled showers
- Installers and builders save time and money and are protected under wedi System warranty covering the entire shower substrate



wedi Fundo Riolito® neo Kit

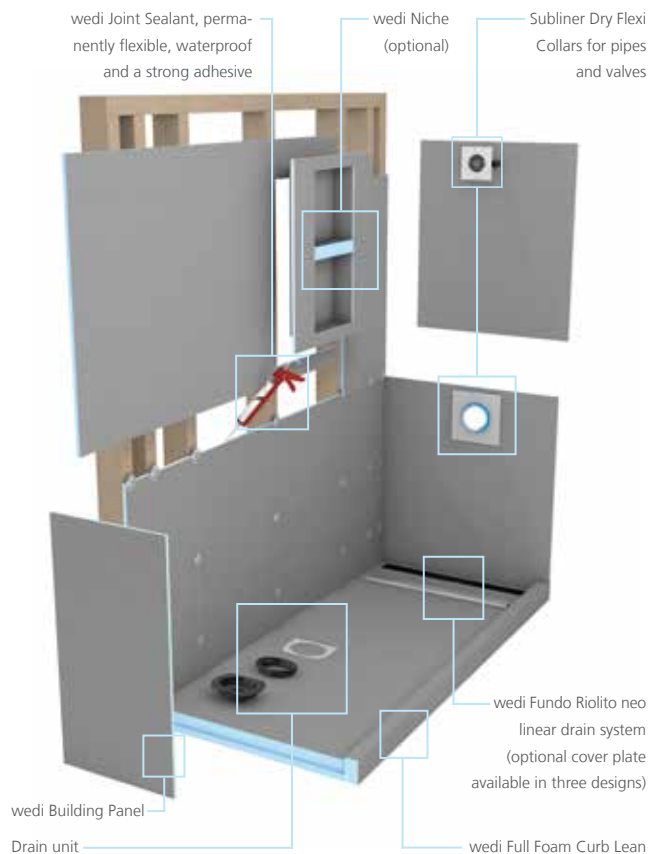



wedi Fundo Primo®

The wedi Fundo Primo Shower System features a square drain cover point drainage solution for fast and safe renovation and new construction installations. Fundo Primo is internally waterproof due to its wedi XPS foam's closed cell structure and naturally protects against mold or mildew like every wedi XPS foam based product. It is fast and clean to cut to fit custom designs while the level of prefabrication reduces installation time significantly. The shower floor units feature a strong and pre-sloped surface which can be tiled over immediately whether you choose mosaic size or large format tile. Drain unit and drain cover set is always included with each Primo shower floor unit while further optional drain cover designs are available. Pre-sloped extension panels are available so that virtually no limit exists for making any size or shape for custom shower designs happen. The added values offered by Fundo Primo come in the form of many more performance advantages. Naturally, Fundo Primo is insulating keeping surfaces warmer. Especially when compared to traditional mortar bed installations or other currently known methods for building showers such as those including use of sheet – or liquid waterproofing membranes used in an attempt to manage water exposure – wedi Fundo Primo's simplicity and high performance shows. The installation combines many manual and separate installation steps and materials usually needed into very few. Fundo Primo adds speed, safety and consistency to your installation: Measure, possibly cut, thinset to subfloor, connect drain – done. The most unique advantage, however, is the complete and natural core waterproofness of the wedi product and its completeness and range of components that will form an entire assembly system with Fundo Primo engineered to fit and last. This is a true system with full warranty coverage.

Product Information

These added values and its detail perfections eliminate the technical concerns in shower installations. However, this is not where wedi shower systems stop offering its added values. The wedi Fundo shower system adds to your productivity and enables you to provide real value to your customers. Our wedi Fundo Shower systems reduce the installation time for just the shower floor from a 2–3 day process (includes drying times) to only 30 minutes when compared to traditional methods built with pre slope, vinyl liner and final mortar bed. wedi helps you to turn showers into service quicker, cleaner and safer. Especially for our contractors, Fundo Primo helps to get to setting tile faster and on a much more consistent and tile friendly surface. Customers will appreciate the “no noise and no dirt/dust” installation. The wedi products do not contain harmful ingredients providing peace of mind to contractors and end users.

Note for Installation

Optionally a glue drain can be obtained from wedi. For a cement glue connection, the floor pipe must be cut 2 1/4" below the surface of the subfloor. Optionally a brass drain can be obtained from wedi. The installation proceeds as shown for the standard ABS drain provided with each Fundo Primo base.

Drain to Base Assembly

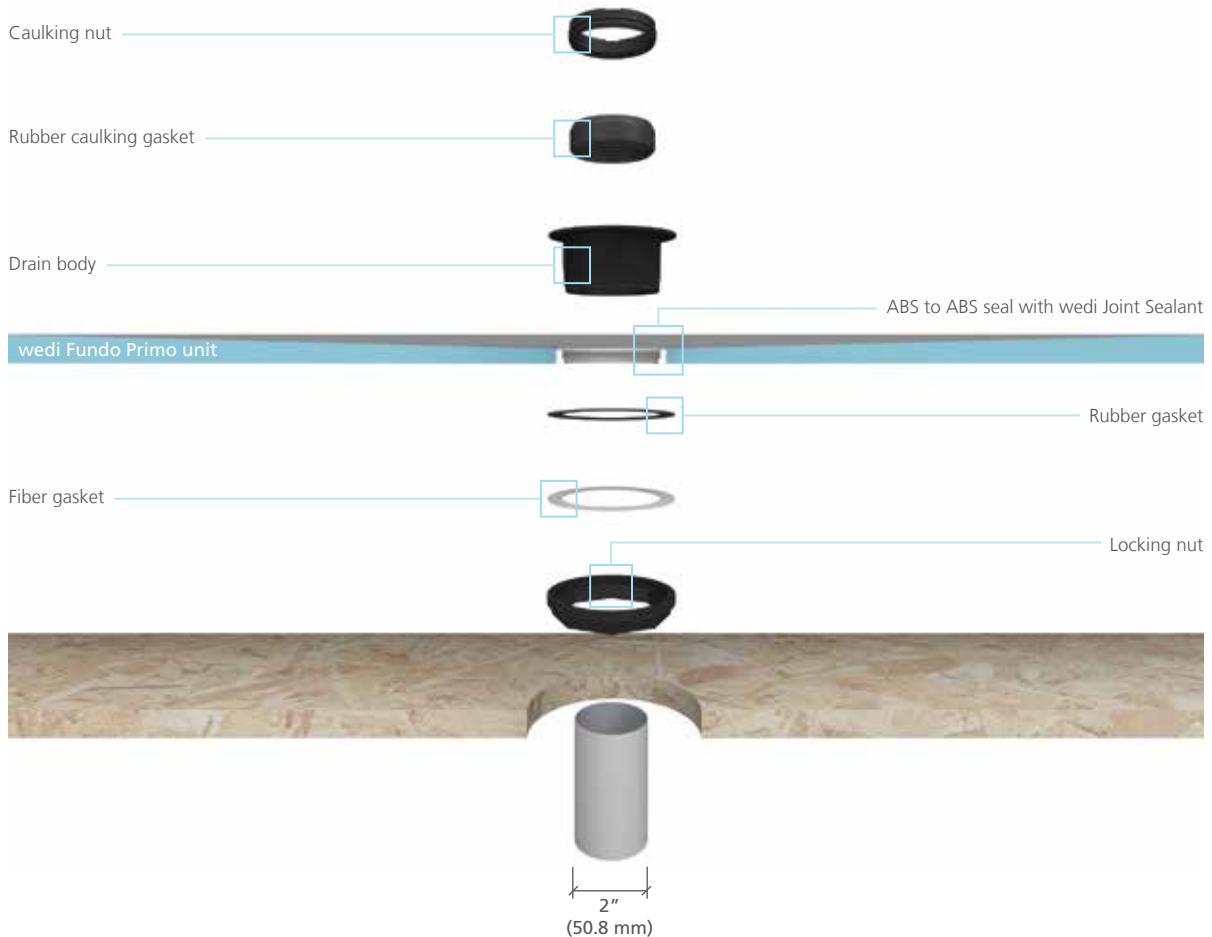

! Note 2" outside diameter is nominal (2 3/8" for PVC/ABS schedule 40 pipe and 2" for cast iron/copper). Several Fundo Primo models naturally feature different perimeter height or thickness at the edge. Therefore, pre-made standard notch connections of wedi curbs must be modified in the field for a tight fit to the bases. Ramps and Extension panels can naturally not fit to all models and might be modified in the field as well.



wedi Fundo Primo® Installation

Before Installation:

- Have 2 × 4 blocking installed over bottom plate between studs along to support wedi Building Panel to shower base transition area.
- Subfloor is stable, even and loadbearing, and meets deflection criteria of maximum L/360 as per IRC. Wooden or concrete structural substrates are dry and sufficiently loadbearing considering live and dead load. Wood and Steel framing is sufficiently loadbearing, plum and square.
- Floor drain assembly below floor is stabilized, fixed and supported in position, and will not sink under water load.
- Only wedi products (Building Panels, Curb, Joint Sealant and Fasteners) are used for wedi Fundo Shower System assembly.
- Installer has received instructions from wedi Technical Sales Staff or is informed about proper installation methods as described.
- wedi Shower Bases can be cut to size using a skilsaw. The Z notch channel must be remade and cleaned from sawdust or other possible contamination.
- Follow applicable state or local plumbing codes requiring specific and dimensioned waterproofed areas for a shower system or other wet room installation. Requirements in this manual supersede local plumbing codes; they extend and are not in conflict. wedi Shower Systems or other wet room installations in which non-wedi product is also used require specific project recommendations by wedi and may reduce the extent and installation area of protection offered by wedi's warranty.



Cut the 2" (50.8 mm) pipe flush (or max. 1/8" [3.2 mm] above) to the floor construction. Make sure that the cut out fits to the Fundo panel drain. Cut out a 5" (127 mm) diameter hole around the 2" (50.8 mm) pipe to allow for the wedi drain to be inserted into the subfloor while the cut out area must remain free of deflection. The drain and trap have to be sturdily fastened to the sub floor. Assemble the drain unit following the instruction drawing.



Set up a continuous 1/4" (6.4 mm) bead of wedi sealant along the top side of the wedi Fundos' valve groove profile. Optionally you can apply the bead on the underside of the main drain body's flange. This will help keeping sealant off the threads of the main drain body when it is inserted.



Drop the drain body firmly into the sealant.

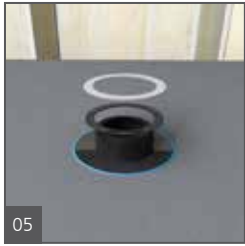

Turn the Fundo base upside down and apply the rubber and the fiber gasket.



Tighten the gaskets firmly to the bases' steel ring using the locking nut. Make sure the drain body is still safely received in the valve-bead of sealant. Smooth out excess sealant over the drain body's flange surface.

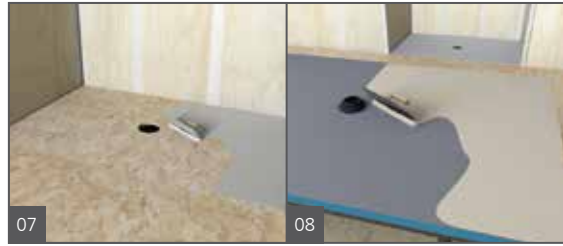

Skim coat the thinset ANSI 118.4 and comb through with a 1/4" x 1/4" (6.4 x 6.4 mm) notched trowel. Channels pointing to the entrance. Trowel the thinset on the rear side of the Fundo again using a 1/4" x 1/4" (6.4 x 6.4 mm) notched trowel. There are different ways to ensure good bond of the wedi Base to the subfloor. Required is a setting bed thickness of min. 3/16" (4.8 mm) and max. of 5/16" (7.9 mm) (compressed). Applying thinset on both, wedi Base and subfloor, is recommended to achieve full surface coverage adhesion. Another best practice is to use fast setting mortar to achieve faster bond and adhesion.



Press the Fundo firmly into the thinset bed, ensuring that the installation is level and void free. Apply some weight equally and leave on surface and drain area to allow the thinset to initially cure without being disturbed (e.g. thinset bags).



Set up the rubber caulking gasket (with the beveled side up) around the 2" (50.8 mm) pipe in the subfloor. The rubber gasket must be flush with the upper end of the 2" (50.8 mm) ABS or PVC pipe. **Do not use any lubricants.**



Tighten (squeeze) the rubber caulking gasket firmly with the caulking nut (use a flat headed screwdriver) and finally insert the plastic frame and strainer on top (without adhesive). The frame and strainer will be held in a grout joint only once tiling commences. Do not tighten the gasket prior to 60 minutes after the threaded drain part was sealed into the shower base.

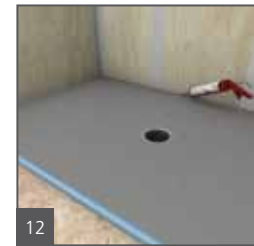

Set up a continuous 1/2" (12.7 mm) bead of wedi Joint Sealant along the pans channel on the outer perimeter and only in areas where you can immediately install a wedi Building Panel into the fresh sealant.



Push the wedi Building Panel all the way into the channel of the shower base channel and its bead of sealant. Smooth out any pushed out sealant on inside seam using a putty knife. Fasten the panels directly to the studs starting 1 ft. (304.8 mm) above the base and in corners while keeping the board pushed down into the channel, and set the fasteners at a rate of 1 fastener per 1 ft. (304.8 mm). 1 extra fastener is set into the seam to the next panel to create a flush transition. wedi requires wedi Building Panels to be installed in all areas exposed to water and in any case no lower than 6" (152.4 mm) above all water inlet fixtures.



Apply continuous 1/2" (12.7 mm) beads of sealant between all connections of panels and install with tightly butted seams. Excess sealant must be spread flat with a putty knife. All seams and fastener heads in the assembly are covered with a secondary 1/2" (12.7 mm) bead of sealant and spread flat. The seams should be covered 1" (25.4 mm) on either side of seam. All fastener/washers are covered with sealant stretching 1" (25.4 mm) over the washer edges.



wedi Niches are installed in a cut out in the wedi wall and attached with it's flange right into the center of 16" (406.4 mm) o.c. studs. wedi Joint Sealant is set along the connection of wall to niche.

2 Fasteners on each side of the niche are set to create a flush transition to the wall panels. Another 1/2" (12.7 mm) bead of wedi Joint Sealant is spread over fasteners and seams.

i For the installation to properly work it is critical to waterproof all penetrations of the wedi product such as shower valves and shower heads using the appropriate sealing gaskets for the application. The wedi Mixing Valve Flexi Collar and wedi Flexi Collar (for 1/2" – 3/4" [12.7 – 19 mm] shower pipe protrusions) are used for these applications and are part of the wedi System complete warranty.

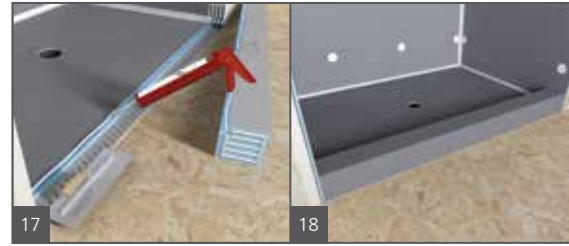

A continuous 1/2" (12.7 mm) bead of sealant is set into the channel and along the vertical curb notch part. A circle of 1/2" (12.7 mm) sealant bead is set against the wall panels (and) or the curb sides where the curb attaches. A 1/2" x 1/2" (12.7 x 12.7 mm) bed of thinset mortar is applied to the subfloor and a skim coat on the bottom surface of the curb as a best practice. The tightly fitting curb is pressed into the connection area. Weight is applied for a minimum of 30 minutes on and against the curb (from outside) and another 1/2" (12.7 mm) bead of sealant is applied over all curb seams and spread flat. The seams must be covered 1" (25.4 mm) either side of a seam.

! Curb connection notches must be cut to fit select Primo bases with perimeter thickness higher than 1 1/2" (38.1 mm).

After Installation

All visible joints or seams in the installation are visibly covered and reinforced with wedi Joint Sealant applied flat over the seams. Coverage of wedi Joint Sealant over all seams should be at least 1 inch (25.4 mm) on either side of the seam. The wedi Joint Sealant should be no less than 1/16 inch (1.6 mm) thick for strength. Do not add mesh tape into the wedi Joint Sealant. This may only put the waterproofing performance at risk and will not strengthen the sealant's or system's resistance against movement related stresses. Once wedi Joint Sealant application over all shower system seams has been completed, an optional water flood test may be performed as early as 2 hours later. The test should not exceed 24 hours and nor should the water level exceed the height of the perimeter seams so that the fresh sealant may continue to a full cure without too much weight added during that process. wedi recommends to test at least the drain connection for its proper seal while a full surface flood test is not technically required for non-absorbing products like wedi but may be required by a building inspection department. When tiling commences, no premixed and organic ("mastic") tile adhesives must be used over wedi Systems in any wet area installation. When tiling the wedi Shower Bases, incl. extensions or ramps, tile thickness should generally not be less than 1/8" (3.2 mm). Choose setting materials appropriate for the type of stone, ceramic or glass tile as well as for a wet area installation. Tile with a square size of 2 x 2" (50.8 x 50.8 mm) or more may be installed using a polymer modified cement based tile adhesive and grout. Tile with a square size of less than 2 x 2" (50.8 x 50.8 mm) may be installed using a polymer modified cement based tile adhesive and require 100% solids epoxy grout. Tile with a square size of 1 x 1" (25.4 x 25.4 mm) or less must be installed using a 100% solids epoxy tile adhesive and grout. Only non-flat bottom pebble stone installations including in part small mosaics may be installed using polymer modified cement based tile adhesive and grout, all flat bottom pebble stone installation are subject to the general tile size based setting materials recommendation outlined above. When installing non-square tile, the length of the shortest tile edge(s) is considered as its square size for the purpose of determining the choice of the setting materials as outlined above.

All tile installations designed to receive heavier point loads such as from wheelchair use, must be grouted using 100% solids epoxy grout. Large format tile may be installed over wedi Fundo shower bases. Cuts may have to be made in consideration of the base's slope lines and so that such tile can always be fully supported by the tile adhesive setting bed and the surface of the wedi Base. Tile adhesive coverage under the tile must be 95% and special care must be taken to achieve good transfer of adhesive to wedi's Shower Base when working with mesh backed tile. Use only solvent and acid free cleaners and sealers on tile and grout installed over wedi product and apply such products only in amounts as needed to treat the surface materials without drenching the substrate. Follow setting materials manufacturer's recommendations and contact wedi with any questions or regarding applications not covered here.

wedi Drain Cover Assembly / Insertion

Insert cover frame into base hole (no glue/no screws). You may caulk between part and tile to create a flexible grout joint. Optional Extension Collar can be cut to height if part is needed. The caulk joint must not create a water barrier damming up the water draining through the thinset bed into the drain from below the tile. Therefore the thinset layer must be continuous toward the drain. Use the black plastic extension collar if you need to raise the wedi frame and cover. Cut extension collar to size and insert below the frame/cover. If not needed, the extension collar may be disposed of as it is not necessary for the functioning of the wedi installation.

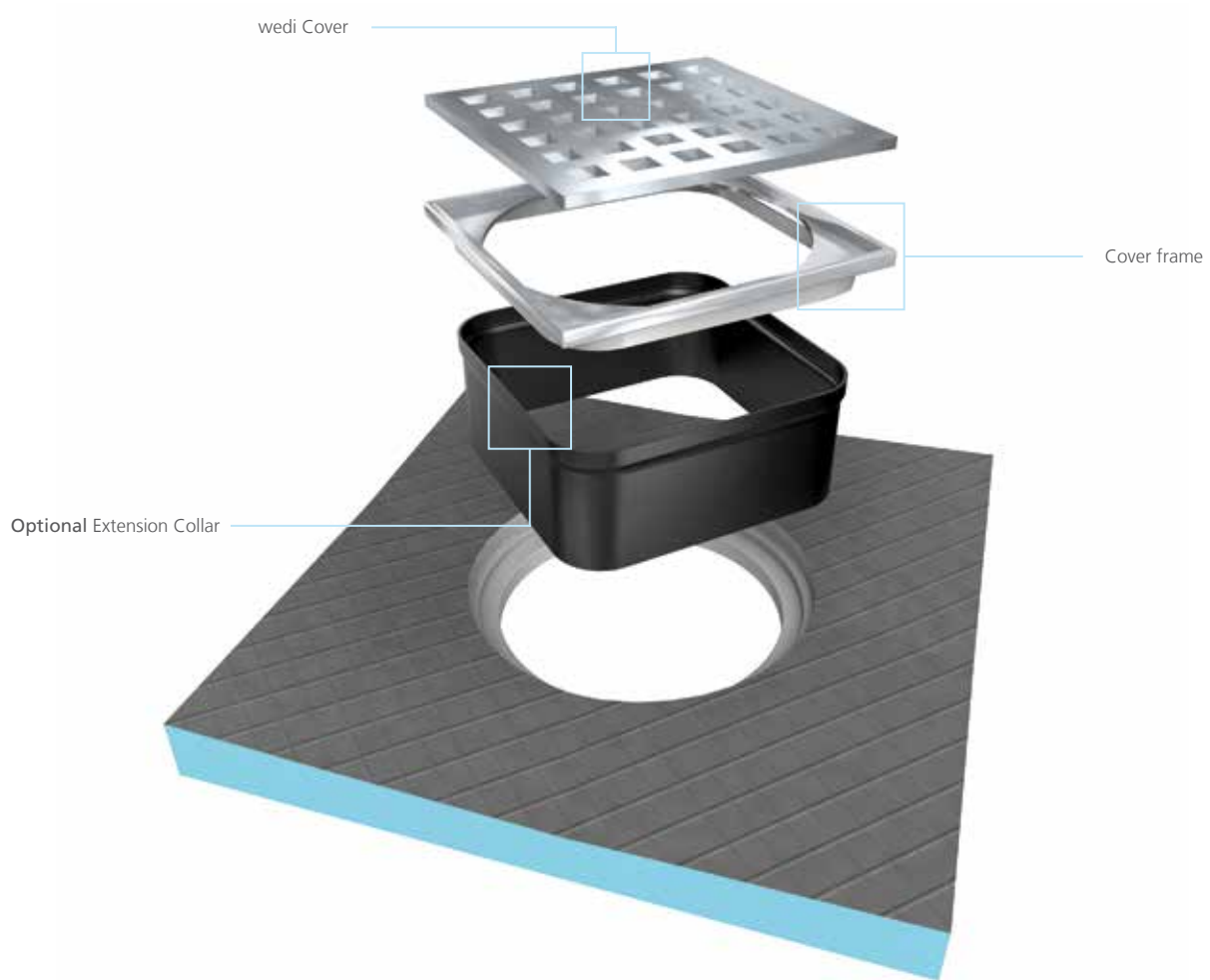

wedi Fundo Primo® Shower Kit – Full Shower System in a Box

All products needed to build a wedi shower are included and provide a single manufacturer warranty. Safe transportation in one box, easy estimating of product quantities needed.

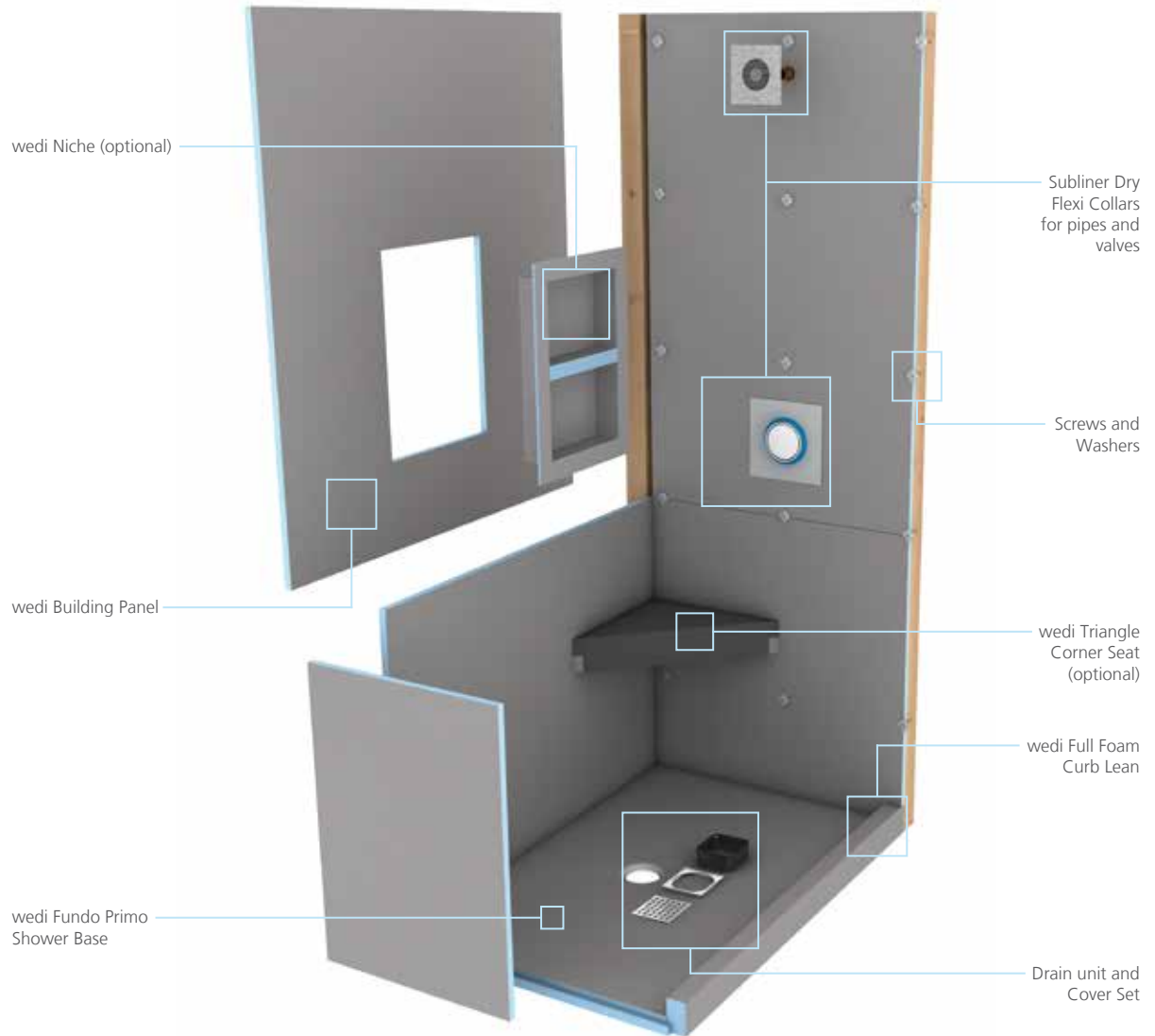





wedi Fundo Ligno®

Homeowners and builders increasingly favor shower spaces which can function without a curb or would not require any build up over existing floor areas resulting in a step up into the shower. One important reason for this trend is it's easier and safer access to the shower for older and/ or physically disabled persons. While this trend offers great design and business opportunities it also presents technical challenges which cannot be overcome by many conventional shower installation methods or products. Main challenges are safe recessing of a sloped shower base into an existing structural floor for a flush transition and the extension of waterproofing from shower area into surrounding floor areas no longer protected by a curb keeping water inside the shower area. To address all challenges for tile professionals, wedi engineered Fundo Ligno, a sloped shower base $\frac{3}{4}$ " thin at its perimeter and available in various sizes. Ligno can be field modified. The installation within a $\frac{3}{4}$ " plywood structure requires no cutting into joists. Load-bearing plywood is simply re-installed between floor joists and over wedi's recess kit bracket system. This guarantees a full support and protection of the tiled surface. The wedi typical strong cement based, reinforced surface is pre-sloped, directly tileable with large or small format tile. The Fundo Ligno interlocks with wedi Building Panel used as waterproof backer board on walls as well as on the surrounding floor. Optionally, wedi's Subliner Dry Sheet Waterproofing membrane can be used. Both options offer a complete and professional system installation.

Product Information

wedi Fundo Ligno is designed to provide for a low profile base thickness of only 3/4" (19 mm). This allows for a fast and flush installation into a subfloor assembly without cutting into floor joists. The system is designed to work without a curb. Enjoy the ease of installation without creating a structural hazard because you maintain the structural subfloor panels installed between floor joists under the wedi Fundo Ligno. Due to barrier free showers potentially being exposed to heavy point loads (e.g. wheel chair), you can confidently rely on the structural strength of the wedi Base and subfloor as well as the wedi Fundo's traditionally ~~not~~ strong cement based surface for ideal tile bond using any suitable cement based tile adhesives or grouts. As applied to all wedi Fundo Shower Systems, wedi Fundo Ligno is designed to interlock and work with wedi Building Panels, wedi Joint Sealant, wedi Fasteners, wedi Seats and Benches, wedi Niches and many more accessories, that truly complete your shower installation and waterproofing system. The installation is fast, modular but customizable, and covered by wedi's full system warranty.

Note for Installation

Optionally a glue drain can be obtained from wedi. For a cement glue connection, the floor pipe must be cut 2 7/8" (73.2 mm) below the surface of the subfloor. Optionally a brass drain can be obtained from wedi. The installation proceeds as shown for the standard drain provided with each Fundo base.

Drain to Base Assembly

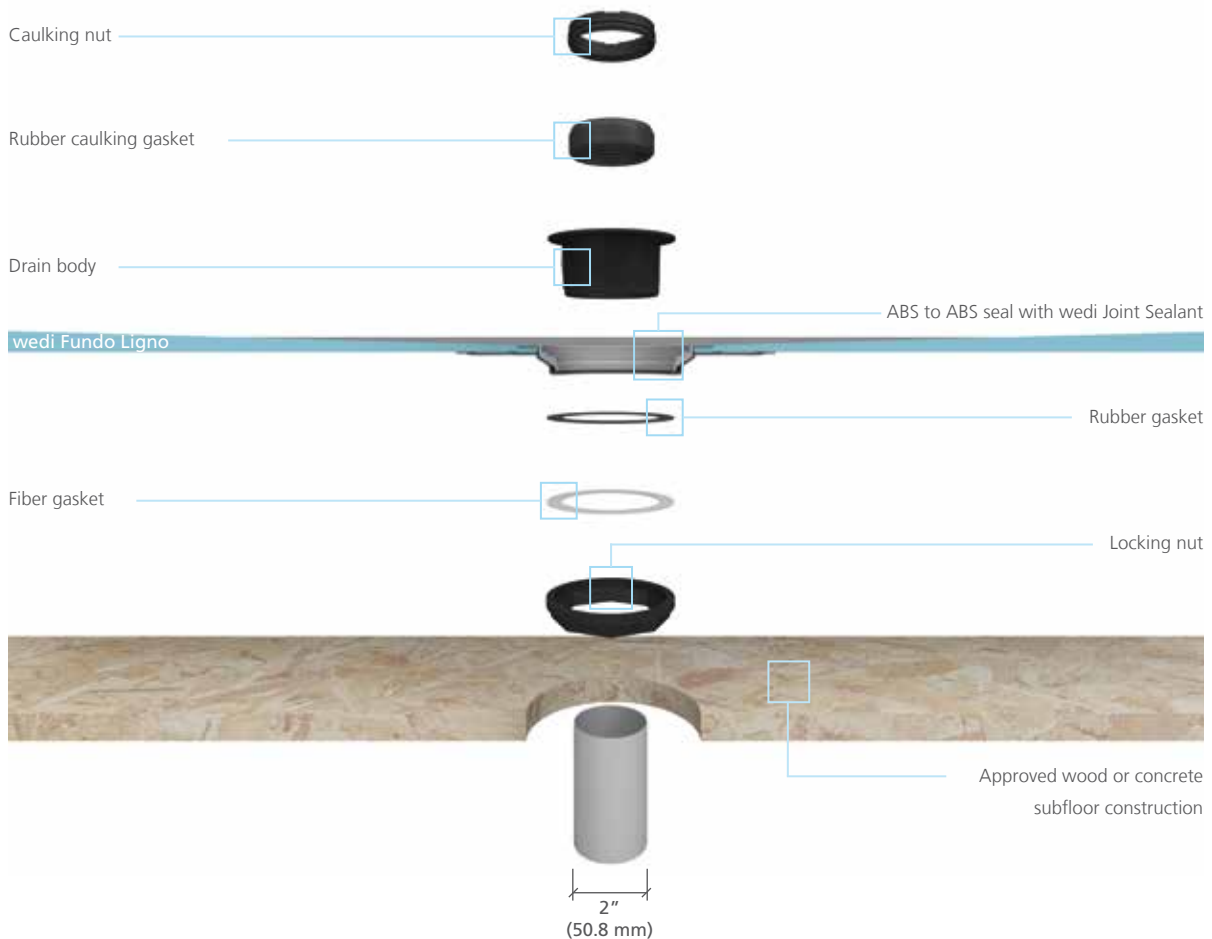

! Note 2" outside diameter is nominal (2 3/8" for PVC/ABS schedule 40 pipe and 2" for cast iron/copper).



wedi Fundo Ligno® Installation

Before Installation:

- Have extra 2 × 4 blocking installed over bottom plate between studs to support wedi Building Panel to shower base transition area.
- After recessing or when system is installed over regular subfloor, subfloor is stable, even and loadbearing, and meets deflection criteria of maximum L/360 and requirements as per IRC. Wooden or concrete structural substrates are dry and sufficiently loadbearing considering live and dead load. Wood and Steel framing is sufficiently loadbearing, plum and square.
- Floor drain assembly below floor is stabilized, fixed and supported in position, and will not sink under water load.
- Only wedi products (Building Panels, Curb, Joint Sealant and Fasteners) are used for wedi Fundo Shower System assembly.
- Installer has received instructions from wedi Technical Sales Staff or is informed about proper installation methods as described.
- wedi Shower Bases can be cut to size using a skilsaw. The Z notch channel must be remade and cleaned from sawdust or other possible contamination.
- Follow applicable state or local plumbing codes requiring specific and dimensioned waterproofed areas for a shower system or other wet room installation. Requirements in this manual supersede local plumbing codes; they extend and are not in conflict. wedi Shower Systems or other wet room installations in which non-wedi product is also used require specific project recommendations by wedi and may reduce the extent and installation area of protection offered by wedi's warranty.

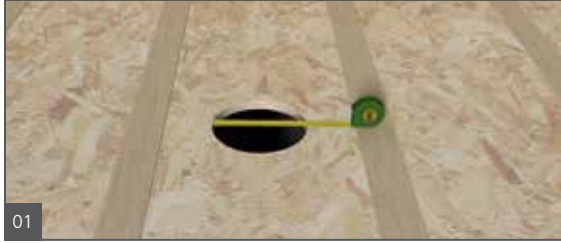

Cut 3/4" (19 mm) wood floor base out fitting the space of wedi Fundo Ligno. Safely install 2 x 6" (50.8 x 152.4 mm) blocking along floor joists and in between floor joists where the perimeter of the Ligno base will be located, install 2 x 6" (50.8 x 152.4 mm) blocking 3/4" (19 mm) below the top of the floor joists. You may also use wedi's Fundo Ligno Recess Installation Kit, which utilizes metal brackets designed to help you recess the wood floor without framing work and can replace the need of 2 x 6" (50.8 x 152.4 mm) sistering of joists and they may be fastened to the structure to suspend the wood floor subfloor. Adjust for thinset thickness under wedi Fundo Ligno base and/or the flooring underlayment installation adjacent to shower area to create a flush transition for waterproofing and tile between floor and shower area. Re-install 3/4" (19 mm) wood floor over blocking or profile system to have the wood floor flush with the floor joists and fill with furring strips on top of floor joists in case the blocking/joist that carry the wood floor under wedi Base is installed higher than 3/4" (19 mm) deep from top of floor joists. Make sure the entire perimeter of the wedi Fundo Ligno base is supported by floor joists or adequate blocking. Make sure the wood floor base shows no seams where close to the cut out for the wedi Fundo Ligno drain. The cutout around the center of the 2" (50.8 mm) floor pipe must be 6 1/2" (165.1 mm) (max 7" [177.8 mm]) in diameter to allow drain recess and must not create any subfloor deflection. The pipe is cut square and even at 5/8" (15.9 mm) below the recessed subfloor top surface.



Assemble the drain unit following the instruction drawing.



Set up a continuous 1/4" (6.4 mm) bead of wedi Joint Sealant along the top side of the wedi Fundo's valve groove profile. Optionally you can apply the bead on the underside of the main drain body's flange. This will help keeping sealant off the threads of the main drain body when it is inserted.



Drop the drain body firmly into the sealant.



Turn the Fundo base upside down and apply the rubber and the fiber gasket.



Tighten the gaskets firmly to the bases' steel ring using the locking nut. Make sure the drain body is still safely received in the valve-bead of sealant. Smooth out excess sealant over the drain body's flange surface.



Skim coat the thinset ANSI 118.4 and comb through with a 1/4" x 1/4" (6.4 x 6.4 mm) notched trowel channels pointing to the entrance.



Trowel the thinset on the rear side of the Fundo again using a 1/4" x 1/4" (6.4 x 6.4 mm) notched trowel. There are different ways to ensure good bond of the wedi Base to the subfloor. Required is a setting bed thickness of min. 3/16" (4.8 mm) and max. of 5/16" (7.9 mm) (compressed). Applying thinset on both, the wedi Base and subfloor, is a best practice recommended to achieve full surface coverage adhesion. Another best practice is to use fast setting mortar to achieve faster bond and adhesion. Press the wedi Fundo firmly into the thinset bed, ensuring that the installation is level and void free. Apply some weight equally and leave on surface and drain area to allow the thinset to initially cure without being disturbed (e.g. thinset bags).



Set up the rubber caulking gasket (with the bevelled side up) around the 2" (50.8 mm) pipe in the subfloor. The rubber gasket must be flush with the upper end of the 2" (50.8 mm) ABS or PVC pipe.

Do not use any lubricants.



60 minutes after initial installation of the drain with wedi Joint Sealant tighten (squeeze) the rubber caulking gasket firmly with the caulking nut (use a flat headed screwdriver) and finally insert the plastic frame and strainer on top (without adhesive). The frame and strainer will be held in a grout joint only once tiling commences. Do not tighten the gasket prior to 60 minutes after the threaded drain part was sealed into the shower base.



Set up a continuous 1/2" (12.7 mm) bead of wedi Joint Sealant along the pans channel on the outer perimeter and only in areas where you can immediately install a building panel into the fresh sealant. Push the wedi Building Panel all the way into the channel of the shower base channel and its bead of sealant. Smooth out any pushed out sealant on the inside seam using a putty knife. Fasten the panels directly to the studs starting 1 ft. (304.8 mm) above the base and in corners while keeping the board pushed down into the channel, and set the fasteners at a rate of 1 fastener per 1 ft. (304.8 mm). One extra fastener is set into the seam to the next panel to create a flush transition. wedi requires wedi Building Panels to be installed in all areas exposed to water and in any case no lower than 6" (152.4 mm) above all water inlet fixtures.

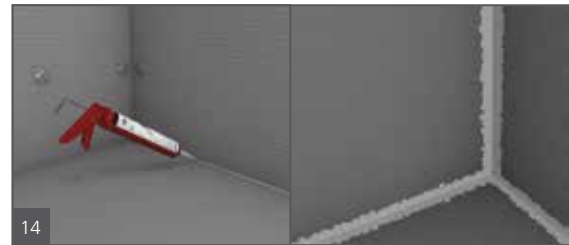

Apply continuous 1/2" (12.7 mm) beads of sealant between all connections of panels and install with tightly butted seams. Excess sealant must be spread flat with a putty knife. All seams and fastener heads in the assembly are covered with a secondary 1/2" (12.7 mm) bead of sealant and spread flat. The seams should be covered 1" (25.4 mm) on either side of seam. All fastener/washers are covered with sealant stretching 1" (25.4 mm) over the washer edges.

i For the installation to properly work it is critical to waterproof all penetrations of the wedi product such as shower valves and shower heads using the appropriate sealing gaskets for the application. The wedi Mixing Valve Flexi Collar and wedi Flexi Collar (for 1/2" – 3/4" [12.7–19 mm] shower pipe protrusions) are used for these applications and are part of the wedi System complete warranty.



wedi Niches are installed in a cut out in the wedi wall and attached with its flange right into the center of 16" (406.4 mm) o.c. studs. wedi Joint Sealant is set along the connection of wall to niche.



2 Fasteners on each side of the niche are set to create a flush transition to the wall panels. Another 1/2" (12.7 mm) bead of wedi Joint Sealant is spread over fasteners and seams.



Fill unused Ligno perimeter channels by sealing in wedi Panel strips (included in box). Prepare to install wedi Subliner Dry waterproofing membrane over the subfloor outside the shower and reaching 4" (101.6 mm) into the Ligno and going up at walls at least 2" (50.8 mm) (flashing) by applying modified thinset using a 1/4 x 1/4" (6.4 x 6.4 mm) notch trowel. The area to be so waterproofed starts 4" (101.6 mm) into the Ligno and extends at minimum 3 ft. (914.4 mm) outside of the shower or as far as shower/spray water may reach. We recommend to waterproof the entire bathroom floor as water may spread below tile level and on top of waterproofing.

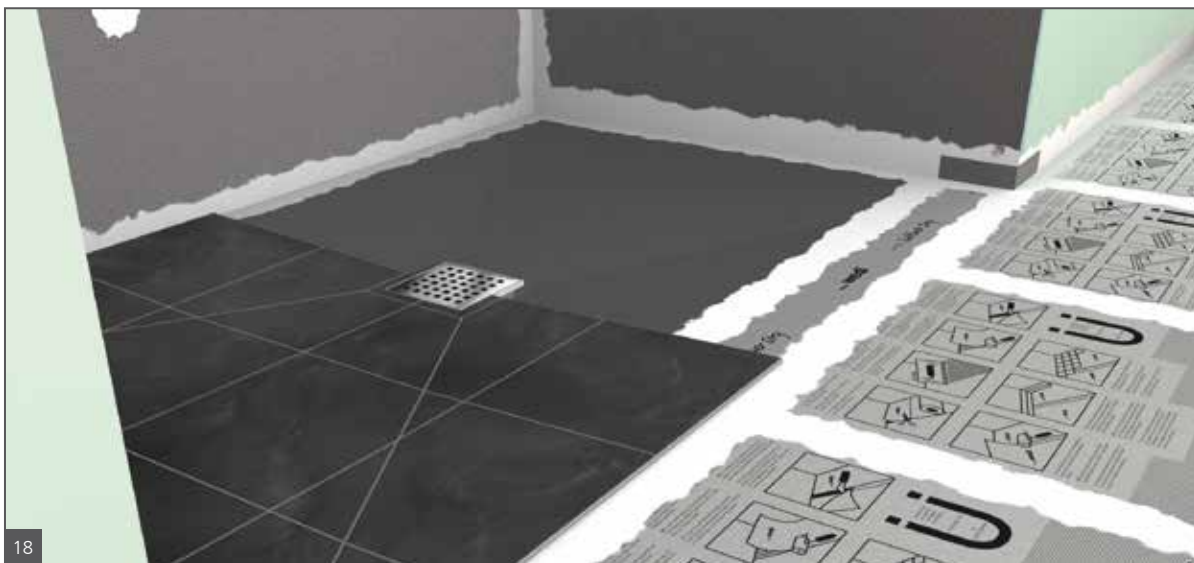

Apply a modified thinset (ANSI 118.4 or equivalent) across the wood or cement board floor surface and now apply wedi Subliner Dry Sheet waterproofing membrane overlapping into the Ligno base for 4" (101.6 mm). Apply wedi's prefabricated outside or inside sealing tape corners and sealing tape or Subliner Dry folds as a flashing to the wedi wall panels/Ligno and Subliner dry sheets as applicable. Install this waterproofing system over the floor substrate outside the shower. All areas subject to water splashes and spray must be waterproofed. wedi recommends to waterproof the entire bathroom floor (including a flashing up into the wall at least to the height of a regular base board or 2" [50.8 mm] high) in spaces where curbless showers are being installed.

Subliner Dry sheet waterproofing membranes are installed to the applicable surfaces using thinset mortar. All overlapping seams between Subliner Dry to wedi Fundo or Building Panel, and between Subliner Dry sheets are sealed with a full bed of wedi Sealant 620 for a width of 2" (50.8 mm). All Subliner Dry tape and prefabricated corner tapes are fully embedded and installed

using wedi Sealant 620. The wedi Sealant 620 can be installed once the thinset mortar below the membrane has cured (see also installation manual wedi Subliner Dry). Your shower is ready for tile once wedi Sealant 620 is dry to the touch. Alternatively to Subliner Dry sheet membrane system wedi Building Panels in 1/4" (6.4 mm) or 1/2" (12.7 mm) and 3/4" (19 mm) thickness (3/4" [19 mm] panel if no recess of base and base connected to Ligno base with a Z notch connection in the panel connecting to Ligno base's channel) can be used as the floor tile underlayment in lieu of cement board and Subliner waterproofing. wedi Building Panel would be installed over wood floor subfloor and overlap and seal into the Ligno channel. In such application the Ligno base must be raised to allow its channel to fully stick out from the recessed area so wedi Floor Building Panels can be interlocked with its channel. All seams to wedi walls or Ligno base are sealed internally with wedi Joint Sealant, and are covered with an external 1/2" (12.7 mm) bead of wedi Joint Sealant spread flat. Your shower is ready for tiling once thinset under wedi Subliner Dry or wedi Building Panels on floor has cured.

After Installation

All visible joints or seams in the installation are fully covered and reinforced with wedi Joint Sealant applied flat over the seams. Coverage of wedi Joint Sealant over all seams should be at least 1" (25.4 mm) on either side of the seam. The wedi Joint Sealant should be no less than 1/16" (1.6 mm) thick for strength. Do not add mesh tape into the wedi Joint Sealant. This may only put the waterproofing performance at risk and will not strengthen the sealants or systems resistance against movement related stresses. Once wedi Joint Sealant application over all shower system seams has been completed, an optional water flood test may be performed as early as 2 hours later. The test should not exceed 24 hours and nor should the water level exceed the height of the perimeter seams, including a temporary dam which should be installed at the entry and 1/2" (12.7 mm) high, so that the fresh sealant may continue to a full cure without too much weight added during that process. wedi recommends to test at least the drain connection for its proper seal while a full surface flood test is not technically required for non-absorbing products like wedi but may be required by a building inspection department.

When tiling commences, no premixed and organic ("mastic") tile adhesives must be used over wedi Systems in any wet area installation. When tiling the wedi Shower Bases incl. extensions or ramps, tile thickness should generally not be less than 1/8" (3.2 mm). Choose setting materials appropriate for the type of stone, ceramic or glass tile as well as for a wet area installation. Tile with a square size of 2 x 2" (50.8 x 50.8 mm) or more may be installed using a polymer modified cement based tile adhesive and grout. Tile with a square size of less than 2 x 2" (50.8 x 50.8 mm) as well as non-flat pebble stones with tile edges less than 2" (50.8 mm) may not be installed over the Fundo Ligno. All tile installations designed to receive heavier point loads such as from wheelchair use, must be grouted using 100% solids epoxy grout. Large format tile may be installed over wedi Fundo shower bases. Cuts may have to be made in consideration of the base's slope lines and so that such tile can always be fully supported by the tile adhesive setting bed and the surface of the wedi Base. Tile adhesive coverage under the tile must be 95% and special care must be taken to achieve good transfer of adhesive to wedi's shower base when working with mesh backed tile. Please use only solvent and acid free cleaners and sealers on tile and grout installed over wedi product and apply such products only in amounts as needed to treat the surface materials without drenching the substrate. Follow setting materials manufacturers recommendations and contact wedi with any questions or regarding applications not covered here.

wedi Drain Cover Assembly / Insertion

Insert cover frame into base hole (no glue/no screws). You may caulk between part and tile to create a flexible grout joint. Optional Extension Collar can be cut to height if part is needed. The caulk joint must not create a water barrier damming up the water draining through the thinset bed into the drain from below the tile. Therefore the thinset layer must be continuous toward the drain. Use the black plastic extension collar if you need to raise the wedi frame and cover. Cut extension collar to size and insert below the frame/cover. If not needed, the extension collar may be disposed of as it is not necessary for the functioning of the wedi installation.

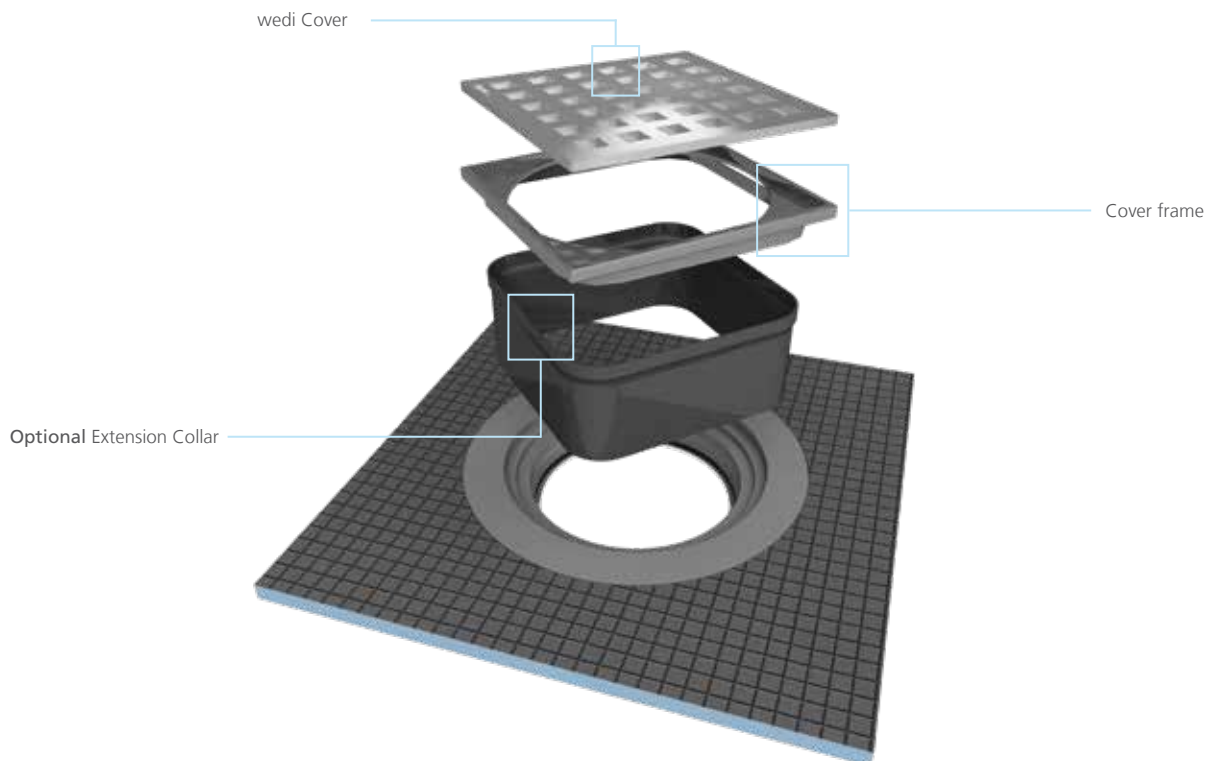





wedi Fundo Ligno® Recess Kit

The Fundo Ligno Recess Installation Kit is designed to help you recess a wood floor between existing floor joists (2x10 joists, engineered or I joist construction) without the need of sistering these joists with more 2x6 or other wood framing material. It will add safety in terms of structural stability of the recess, but will also allow for a safe installation process, and save much time compared to working with framing material only.

The wedi recess bracket support system will allow a 3/4" wood floor to be solidly situated between and flush with joists. The bracket system connects, carries and supports the recessed wood not only along floor joists but also along surrounding subfloor (not recessed) as well as sides of the shower where the wood meets the framing bottom plates.

Please ensure the general subfloor construction, prior to installing the wedi system meets current IRC requirements for structural construction and dead and live load minimums, as well as a deflection potential of less than L/360. Once the wedi Bracket System is installed, and the recessed floor is in place, all requirements will still be met or exceeded. The system comes in one box equipped with two different profile types and all the hardware needed. One Kit covers recess spaces for a Fundo Ligno up to 5 x 5 ft. in size. Do not use this system for any other recessed shower installations except wedi Fundo Ligno system.



01 Measure and mark subfloor to be removed. Use a safe saw to cut close to the framing but also in a safe and clean way. wedi recommends a combination of saws including a sawzall and a saw like Dremel (r) US40 01 120 V where a standard circular saw might not reach.

Make sure your 2" (50,8 mm) floor waste pipe is installed and positioned to fit the Ligno shower base drain. The pipe must be cut 5/8 inch (15,9 mm) below the surface of the recessed floor to be installed between the joists. A 6 1/2" (165,1 mm) cut out must be made into that floor strip with the drain pipe in its center. It is important to position the drain and cut out to not interfere with a floor joist.



02 Cut the joist brackets to the length of the exposed floor joists. Depending on length and direction of floor joists you may need to add a shorter joist bracket. Please do not use joist brackets shorter than 12" (304,8 mm) or equipped with less than two (at least partial) mounting flanges.



03 Install the joist brackets to the floor joist using the flat head Phillips wood screws provided by wedi. Set one (1) screw per each mounting flange in the center screw hole (unless bracket is cut which is when at minimum two mounting flanges must be fastened using available screw holes). Brackets should be aligned with top and side of floor joists but allowing for up to 1/8" and minimum of 1/16" of space between the floor joist's vertical side and the metal bracket. This helps mitigating wood movement and irregularities in the floor joist itself without creating too much tension.

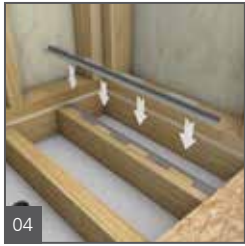

04 Fasten the next bracket on the other side of the floor joist. Stagger the tabs, so you may need to cut the brackets.



05 Repeat process shown under 4. and install joist brackets to all exposed joists.



06 Place C brackets at the wall sides. The C brackets are installed at both ends of the recess area first and then along the wall / side every 12" (center of C bracket to center of C bracket).



07 The C brackets are inserted with their claws between floor surface and underside of the base plate. Use a wood block or a hard rubber mallet to push C brackets into position.



08 Make sure the C Brackets are mounted in a level position (assuming a level base plate) and use flathead Phillips self-drilling screws with wings provided by wedi. Fasten through the base plate and into the two (2) metal claws resting between base plate and wood floor top.



09 Install one (1) C bracket against the wall and centered between each pair of floor joists (if joist spacing 16" o.c.). If the Joist spacing is greater than 16" o.c. please install two (2) C brackets centered between each pair of floor joists.

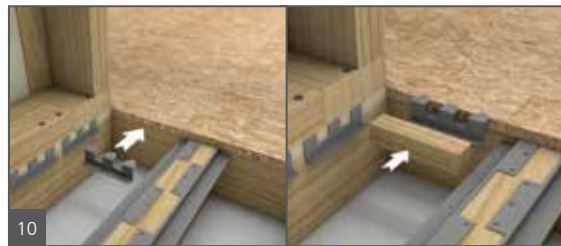

10 Dry fit C brackets to the edge of the wood floor to ensure C Brackets can be installed for full support along the edge of the floor plate. Use a wood block or hard rubber mallet to push the brackets in position.



11 Use flat head Phillips self-drilling screws with wings provided by wedi to fasten C brackets to the edge of the wood floor plate at the open side of the future shower area. Fit brackets between flanges of joist/wall brackets. Use two (screws) to fasten this bracket through the wood floor and into the lower claws. When working with floor joists with a spacing greater than 16", use 1 full C bracket and another one cut to length for full support along the edge of the floor.



12 Measure and mark to cut wood strips tightly fitting into the recess bracket support system between joists, wall framing and regular subfloor. Leave a 1/8" (3,2 mm) gap between wood strips and brackets so the wood may move without creating too much tension.



13 Cut the wood floor strips incl. the strip for the drain area featuring a 6 1/2" (165,1 mm) diameter hole to be seated over the center of the floor waste pipe.



14
Clean and degrease the bracket support flanges/surfaces and apply a 1/4" (6.35 mm) bead of wedi Joint Sealant. Use wedi Joint Sealant or a construction adhesive suitable for metal and wood application.



15
Place all wood strips into position on brackets.



16
Secure wood strips to C and Joist brackets using flat head Phillips self-drilling screws with wings as provided by wedi. Fasten at minimum every 10 (ten) inches where joist brackets are present, or where C brackets are in line along the framed wall and parallel to the floor joists. Fasten wood into all other C brackets with a minimum of two (2) screws where singular C Brackets are mounted between floor joists on wall framing or wood floor transition side.



17
Install wedi Fundo Ligno in a bed of tile adhesive as per Ligno installation manual.



18
Your Ligno shower is now flush with the surrounding subfloor and is supported by a subfloor with absolute structural integrity, so important for safe tile installation and without the risk of cracks in tile or grout so typical to tile substrate installations or shower systems installed with insufficient support.

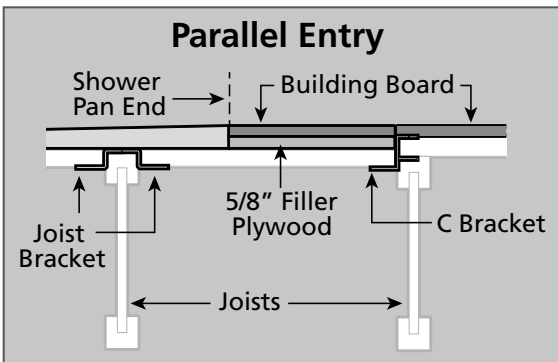

i When joists are parallel to the shower entry, the transition to recessed floor needs to be placed on the front (the edge of a joist adjacent to the recessed part) edge of floor joist regardless of placement. Sometimes the recess needs to be extended past the intended shower pan. The space will be treated the same as any recessed one but filled back in with 5/8" (15,9 mm) thick plywood up to the intended shower pan. This Product is for use with wedi Fundo Ligno Shower System only. The Product is tested and warranted exclusively for this use. Please do not use this product to recess a subfloor and install any other shower or building structure in such recess supported by this product. wedi Ligno Recess Installation Kit has undergone thorough testing and passed Robinson Test C627 for floor assemblies.





wedi Fundo Riolito® neo

wedi's pre-sloped Fundo Riolito neo Shower Base features fully factory sealed and integrated linear drainage systems. The base itself is naturally waterproof as well as mold proof, due to its closed cell XPS foam core. The Fundo Riolito neo bases come with the wedi typically strong and ready for tiling surface coating. All Fundo Riolito neo shower bases can be field modified. They can be cut to size or extended using wedi's pre-sloped Fundo extensions.

The integrated drain in Fundo Riolito neo ensures your installation is not exposed to the risk commonly associated with bonding flange design/surface waterproofing installation-type, single drain products. The unique wedi Fundo Riolito neo bases allow water to drain away through a narrow gap between their drains cover plate and the tile surface finish. wedi Fundo Riolito neo is always equipped with the drain unit but covers are ordered separately. Options for covers include a polished stainless steel version, a double plated brushed stainless steel version, and a tileable version.

Available in 4-way and 2-way or single slope designs with close to the wall drains, wedi Riolito neo features the industries only factory sealed drain for use in custom shower configurations. What is more, the Fundo Riolito neo is available in one piece shower base panels or as a modular system offering a separate drain module and an extension module to combine and configure custom layouts even easier.

Product Information

Several models with 4-way slope fields provide for a perfect installation when recessing the base into a subfloor where a flush to the floor entry is required. The second option includes models with a true one way slope towards the linear drain. This latter option is especially designed to accommodate tub to shower conversions without the need to ever move the floor drain pipe.

Linear Drain Shower Floor Solutions

wedi's Fundo Riolito neo linear drain shower bases feature the only fully sealed and factory integrated waterproof drain assembly available in the market of customizable shower floor systems with linear drainage.

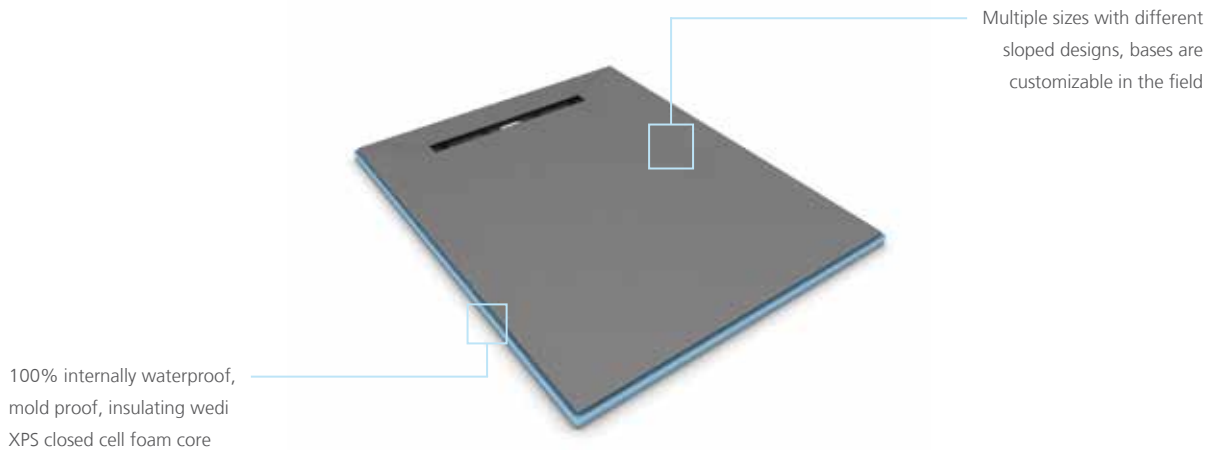

Drain to Base Assembly

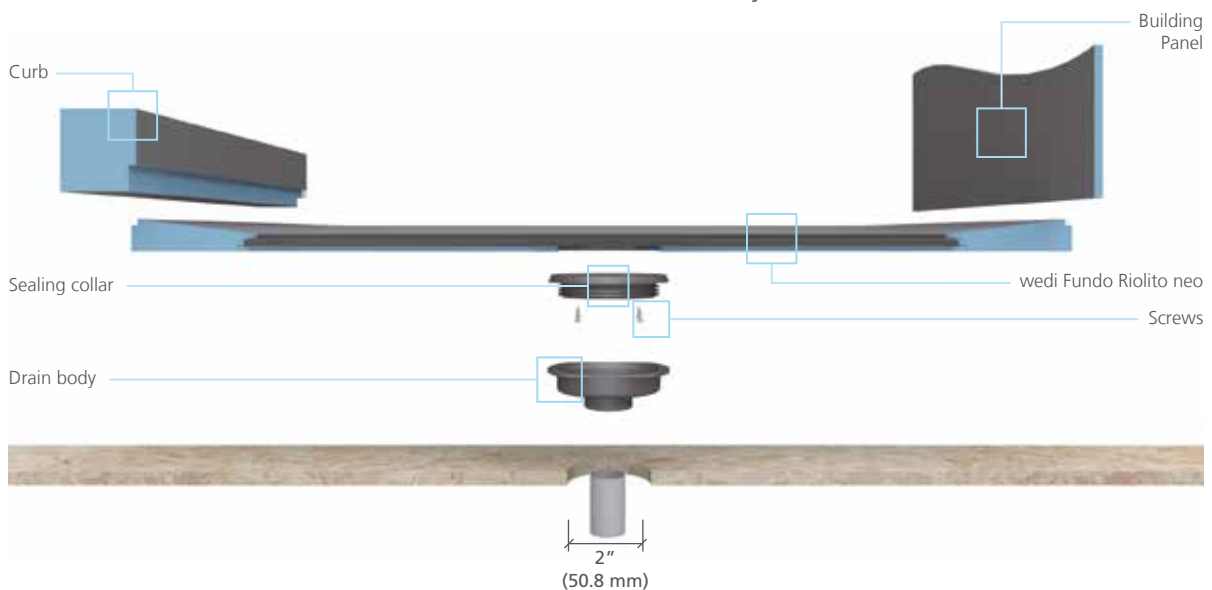

! Note 2" outside diameter is nominal (2 3/8" for PVC/ABS schedule 40 pipe and 2" for cast iron/copper). Fundo Riolito neo employs different drain and drain cover assembly parts. Please refer to the installation manual in the actual product box. In this section Fundo Riolito neo we are showing the Fundo Riolito neo Drain and Drain Cover parts and assembly. Several Riolito neo models naturally feature different perimeter height or thickness at the edge. Therefore, pre-made standard notch connections of wedi curbs must be modified in the field for a tight fit to the bases. Ramps and Extension panels can naturally not fit to all models and might be modified in the field as well.

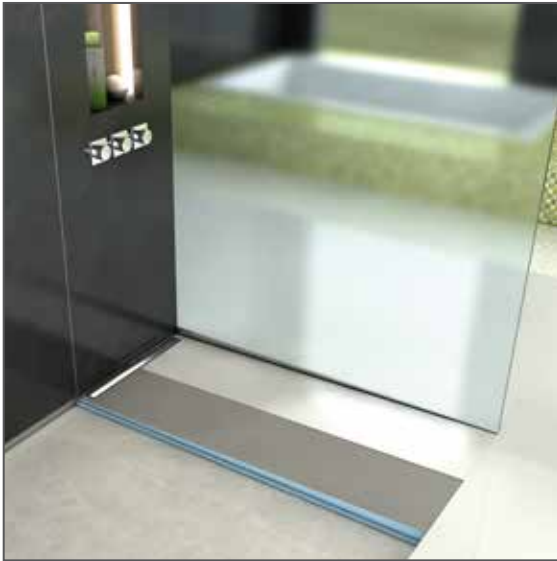

wedi Fundo Riolito® neo Installation

Before Installation:

- Have extra 2 × 4 blocking installed over bottom plate between studs along to support wedi Building Panel to shower base transition area.
- Subfloor is stable, even and loadbearing, and meets deflection criteria of maximum L/360 and requirements as per IRC. Wooden or concrete structural substrates are dry and sufficiently loadbearing considering live and dead load. Wood and Steel framing is sufficiently loadbearing, plum and square.
- Floor drain assembly below floor is stabilized, fixed and supported in position, and will not sink under water load.
- Only wedi products (Building Panels, Curb, Joint Sealant and Fasteners) are used for wedi Fundo Shower System assembly.
- Installer has received instructions from wedi Technical Sales Staff or is informed about proper installation methods as described.
- wedi Shower Bases can be cut to size using a skilsaw. The Z notch channel must be remade and cleaned from sawdust or other possible contamination.
- Follow applicable state or local plumbing codes requiring specific and dimensioned waterproofed areas for a shower system or other wet room installation. Requirements in this manual supersede local plumbing codes; they extend and are not in conflict. wedi Shower Systems or other wet room installations in which non-wedi product is also used require specific project recommendations by wedi and may reduce the extent and installation area of protection offered by wedi's warranty.



01

Cut the 2" (50.8 mm) pipe 1 1/4" (31.8 mm) below the top of the Subfloor. Use the oval shape cutting template where you want to position the drain to cut out subfloor using a jig-saw to allow wedi drain trap to be inserted and connected to floor pipe using appropriate ABS compatible or multipurpose cement glue. Please also check cement glue compatibility to floor pipe material. The drain and trap have to be secured to the subfloor. Drain recess cut out must not add deflection to subfloor.



02

Assemble the drain unit following the instruction drawing. wedi's Fundo Riolito neo bases can be cut to size on all sides making drain positions as close to the wall possible. Do not cut into the linear drains plastic flange integrated into the coated foam part of the base. Once cut the 1/2" × 1/2" (12.7 × 12.7 mm) channels at the new base perimeter must be reestablished. When cutting close to the drain channel always leave enough wedi foam for re-making the needed 1/2" × 1/2" (12.7 × 12.7 mm) channel.



03

Glue and seal the wedi drain trap to the 2" (50.8 mm) pipe using appropriate solvent cement glue for the plastics involved. Do not screw drain body/trap to floor. Secure with some dabs of wedi Joint Sealant under flange instead. Mount the oval sealing collar/gasket to the base's receiving ABS plastic channel on it's underside with no gaps showing in between both parts. Use only the wedi screws provided and manually tighten with a Phillips screwdriver. Instead of gluing the drain trap to the floor pipe first, you may also connect it to the wedi Base's sealing gasket first to ensure a visibly tight connection. The trap will then be glued to the floor pipe later when the base is installed to the floor.



04

Apply a skim coat and finally a combed through bed of a thinset using modified thinset ANSI 118.4 and 1/4" × 1/4" (6.4 × 6.4 mm) notch trowel. There are different ways to ensure good bond of the wedi Base to the subfloor. Required is a setting bed thickness of min. 3/16" (4.8 mm) and max. of 5/16" (7.9 mm) (compressed). Applying thinset on both, wedi Base and subfloor, is a best practice recommended to achieve full surface coverage adhesion. Another best practice is to use fast setting mortar to achieve faster bond and adhesion.



Trowel the thinset on the rear side of the Fundo again using a 1/4" x 1/4" (6.4 x 6.4 mm) notch trowel. Press the Fundo firmly into the thinset bed, ensuring that the installation is level and void free. Do not bend or apply uneven pressure when pressing the part into thinset bed and drain trap. This may break the unit's seals. Ensure wedi drain's sealing gasket is firmly inserted in the wedi trap with no chance that thinset could have pushed into this connection area. This is a tight fit so you should use some water or safe plumbers grease to help. When using plumbers grease, the gasket may retract upward so you need some temporary weight here to keep it fully inserted (thinset bag or tile box). Apply some weight equally and leave on surface and drain area to allow the thinset to initially cure without being disturbed (e.g. thinset bags). Do not step on the drain module to push/connect to drain body or thinset. Ensure there is 100% thinset supporting the drain channel area over a completely flat subfloor.



Set up a continuous 1/2" (12.7 mm) bead of wedi Joint Sealant at the perimeter channel and only in areas where you can immediately install a wedi Building Panel into the fresh sealant. Push the wedi Building Panel all the way into the channel of the shower base channel and its bead of sealant. Smooth out any pushed out sealant on inside seam using a putty knife. Fasten the panels directly to the studs starting 1 ft. (304.8 mm) above the base and start fastening in corners while keeping the board pushed down into the channel, and set the fasteners at a rate of 1 fastener per 1 ft. (304.8 mm). 1 extra fastener is set into the seam to the next panel to create a flush transition. wedi requires wedi Building Panels to be installed in all areas exposed to water and in any case no lower than 6" (152.4 mm) above all water inlet fixtures.



Apply a continuous 1/2" (12.7 mm) bead of sealant between all connections of panels and install with tightly butted seams. Excess sealant must be spread flat with a putty knife. All seams and fastener heads in the assembly are covered with a secondary 1/2" (12.7 mm) bead of sealant and spread flat. The seams should be covered 1" (25.4 mm) on either side of seam. All fastener/washers are covered with sealant stretching 1" (25.4 mm) over the washer edges.



wedi Niches are installed in a cut out in the wedi wall and attached with its flange right into the center of 16" (406.4 mm) o.c. studs. wedi Joint Sealant is set along the connection of wall to niche.



2 Fasteners on each side of the niche are set to create a flush transition to the wall panels. Another 1/2" (12.7 mm) bead of wedi sealant is spread over fasteners and seams.



A continuous 1/2" (12.7 mm) bead of sealant is set into the channel and along the vertical curb notch part. A circle of 1/2" (12.7 mm) sealant bead is set against the wall panels and/or the curb sides where the curb attaches. A 1/2" x 1/2" (12.7 x 12.7 mm) bed of thinset mortar is applied to the subfloor and just a skimcoat on the foam bottom part of the curb as a best practice. The tightly cut to fit curb is pressed into the connection. Weight is applied for a minimum of 30 minutes on and against the curb (from outside) and another 1/2" (12.7 mm) bead of sealant is applied over all curb seams and spread flat. The seams must be covered 1" (25.4 mm) either side of a seam.

! Curb connection notches must be cut to fit select Fundo Riolito neo base with perimeter thickness higher than 1 1/2" (38.1 mm).

i For the installation to properly work it is critical to waterproof all penetrations of the wedi product such as shower valves and shower heads using the appropriate sealing gaskets for the application. The wedi Mixing Valve Flexi Collar and wedi Flexi Collar (for 1/2" – 3/4" [12.7–19 mm] shower pipe protrusions) are used for these applications and are part of the wedi System complete warranty.

See important considerations "After Installation" in wedi Fundo Riolito neo Modular manual on the following pages.



wedi Fundo Riolito® neo Modular

wedi's Fundo Riolito neo System feature the only fully sealed and factory integrated waterproof drain assembly available in the market of customizable shower floor systems with linear drainage.

They are available in two design options. The first option includes models featuring a one-piece shower base including the drain trench. These provide 1-way or 4-way slopes. The second option, Riolito neo Modular is designed to offer more flexibility as it consists of two basic elements: one module including the line module which is a trench drain integrate in a wedi Base module, the other being a sloped extension panel. Drainage can be installed close to the wall or two extension models leading away from either side of an i.e. centered drain. The line modules may also be used with mortar bed shower applications (to be topically waterproofed using wedi Subliner Dry, connecting to the Riolito neo line module).

Linear Drain Shower Floor Solutions

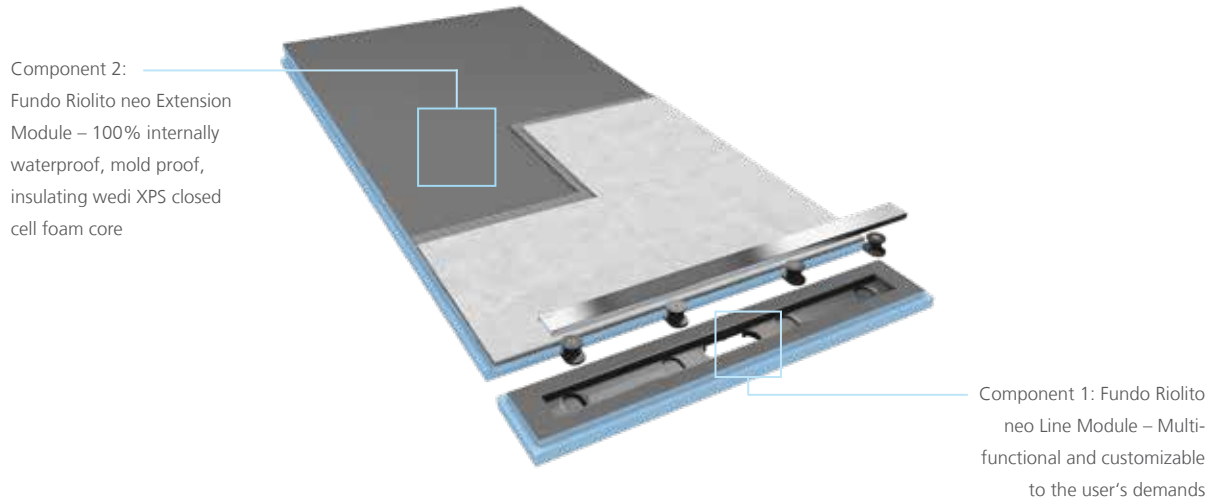

Drain to Base Assembly

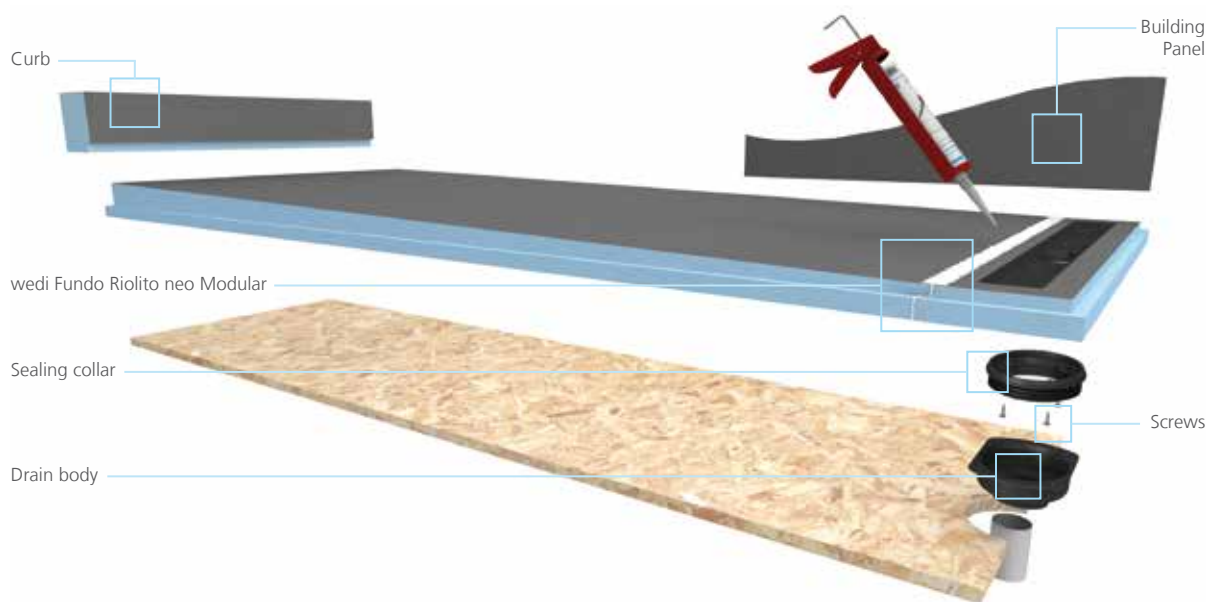

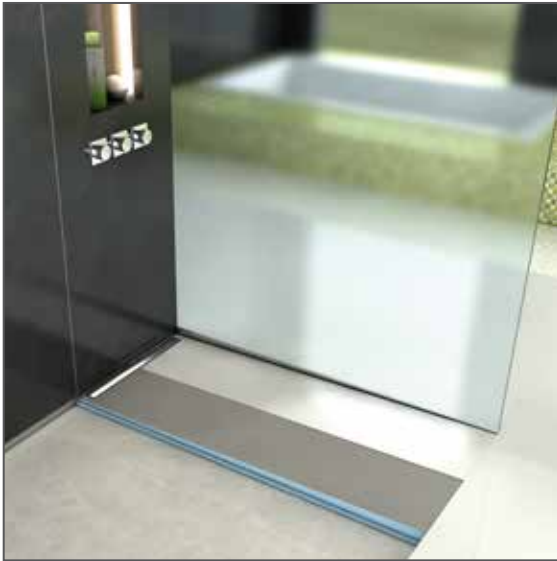

wedi Fundo Riolito® neo Modular Installation

Before Installation:

- Have extra 2 × 4 blocking installed over bottom plate between studs along to support wedi Building Panel to shower base transition area.
- Subfloor is stable, even and loadbearing, and meets deflection criteria of maximum L/360 and requirements as per IRC. Wooden or concrete structural substrates are dry and sufficiently loadbearing considering live and dead load. Wood and Steel framing is sufficiently loadbearing, plum and square.
- Floor drain assembly below floor is stabilized, fixed and supported in position, and will not sink under water load.
- Only wedi products (Building Panels, Curb, Joint Sealant and Fasteners) are used for wedi Fundo Shower System assembly.
- Installer has received instructions from wedi Technical Sales Staff or is informed about proper installation methods as described.
- wedi Shower Bases can be cut to size using a skilsaw. The Z notch channel must be remade and cleaned from sawdust or other possible contamination.
- Follow applicable state or local plumbing codes requiring specific and dimensioned waterproofed areas for a shower system or other wet room installation. Requirements in this manual supersede local plumbing codes; they extend and are not in conflict. wedi Shower Systems or other wet room installations in which non-wedi product is also used

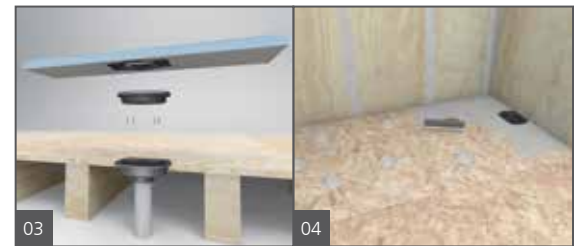

Cut the 2" (50.8 mm) pipe 1 1/4" (31.8 mm) below the top of the Subfloor. Use the oval shape cutting template where you want to position the drain to cut out subfloor using a jigsaw to allow wedi drain trap to be inserted and connected to floor pipe using appropriate ABS compatible or multipurpose cement glue. Please also check cement glue compatibility to floor pipe material. The drain and trap have to be secured to the subfloor. Drain recess cut out must not add deflection to subfloor.

Assemble the drain unit following the instruction drawing. wedi's Fundo Riolito neo bases can be cut to size on all sides making drain positions close to the wall possible. Do not cut into the linear drains plastic flange integrated into the coated foam part of the base. Once cut the 1/2" × 1/2" (12.7 × 12.7 mm) channels at the new base perimeter must be reestablished. When cutting close to the drain channel always leave enough wedi foam for re-making the needed 1/2" × 1/2" (12.7 × 12.7 mm) channel. Never bend or pressure the modular drain unit when handling or installing the gasket. Always work on it with the unit laying on a flat and supporting surface.

Glue and seal the wedi drain trap to the 2" (50.8 mm) pipe using appropriate solvent cement glue for the plastics involved. Do not screw drain body/trap to floor. Secure with some dabs of wedi Joint Sealant under flange instead. Mount the oval sealing collar/gasket to the base's receiving ABS plastic channel on it's underside with no gaps showing in between both parts. Use only the wedi screws provided and manually tighten with a Phillips screwdriver. Instead of gluing the drain trap to the floor pipe first, you may also connect it to the wedi Base's sealing gasket first to ensure a visibly tight connection. The trap will then be glued to the floor pipe later when the base is installed to the floor.

Apply a skim coat and finally a combed through bed of a thinset using modified thinset ANSI 118.4 and 1/4" × 1/4" (6.4 × 6.4 mm) notch trowel. There are different ways to ensure good bond of the wedi Base to the subfloor. Required is a setting bed thickness of min. 3/16" (4.8 mm) and max. of 5/16" (7.9 mm) (compressed). Applying thinset on both, wedi Base and subfloor, is a best practice recommended to achieve full surface coverage adhesion. wedi recommends to cut and dry fit both floor modules to shower stall size and drain location. Another best practice is to use fast setting mortar to achieve faster bond and adhesion.

i For the installation to properly work it is critical to waterproof all penetrations of the wedi product such as shower valves and shower heads using the appropriate sealing gaskets for the application. The wedi Mixing Valve Flexi Collar and wedi Flexi Collar (for 1/2" – 3/4" [12.7–19 mm] shower pipe protrusions) are used for these applications and are part of the wedi System complete warranty.

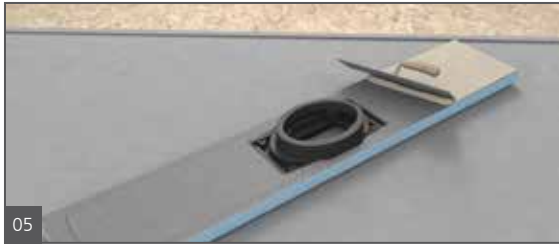

05

Trowel the thinset on the rear side of the Fundo Riolito neo Module "Drain" again using a 1/4" x 1/4" (6.4 x 6.4 mm) notch trowel. Press the Fundo Riolito neo Module "Line Drain" into the thinset so that the sealing gasket moves smoothly into the drain body without contamination through thinset. Do not bend or apply uneven pressure when pressing the part into thinset bed and drain trap. This is a tight fit so you should use some water or safe plumbers grease to help. When using plumbers grease, the gasket may retract upward so you need some temporary weight here to keep it fully inserted (thinset bag or tile box). Carefully apply weight equally and leave on surface and drain area to allow the thinset to initially cure



06

without being disturbed (e.g. thinset bags). Ensure there is 100% thinset supporting the drain channel area over a completely flat subfloor. This may break the units seals. Make sure the entire wedi cement coated underside of the drain module will have thinset support/coverage. Do not step on the drain module to push/connect to drain body or thinset. Apply a 1/2" (12.7 mm) bead of wedi Joint Sealant to the module's Z notch channel and insert the second module, the "Extension". The module "Extension", once cut to length, is also installed using thinset mortar and using the same technique as shown under 4. Apply a 1/2" (12.7 mm) bead of wedi Joint Sealant over the seam between both modules and spread flat using a putty knife.



07 08

Set up a continuous 1/2" (12.7 mm) bead of wedi Joint Sealant at the perimeter channel and only in areas where you can immediately install a wedi Building Panel into the fresh sealant. Push the wedi Building Panel all the way into the channel of the shower base channel and its bead of sealant. Smooth out any pushed out sealant on inside seam using a putty knife. Fasten the panels directly to the studs starting 1 ft. (304.8 mm) above the base and at a rate of 1 fastener per 1 ft. (304.8 mm). 1 extra fastener is set into the seam to the next panel to create a flush transition. wedi requires wedi Building Panels to be installed in all areas exposed to water and in any case no lower than 6" (152.4 mm) above all water inlet fixtures.



09

Apply continuous 1/2" (12.7 mm) bead of sealant between all connections of panels and install with tightly butted seams. Excess sealant must be spread flat with a putty knife. All seams and fastener heads in the assembly are covered with a secondary 1/2" (12.7 mm) bead of sealant and spread flat. The seams should be covered 1" (25.4 mm) on either side of seam. All fastener/washers are covered with sealant stretching 1" (25.4 mm) over the washer edges.



10

wedi Niches are installed in a cut out in the wedi wall and attached with its flange right into the center of 16 o.c. (406.4 mm) studs. wedi Joint Sealant is set along the connection of wall to niche.



11

2 Fasteners on each side of the niche are set to create a flush transition to the wall panels. Another 1/2" (12.7 mm) bead of wedi sealant is spread over fasteners and seams.



12

A continuous 1/2" (12.7 mm) bead of sealant is set into the channel and along the vertical curb notch part. A circle of 1/2" (12.7 mm) sealant bead is set against the wall panels and/or the curb sides where the curb attaches. A 1/2" x 1/2" (12.7 x 12.7 mm) bed of thinset mortar is applied to the subfloor. The tightly cut to fit curb is pressed into the connection. Apply weight for at least 30 minutes on and against the curb (from the outside) and another 1/2" (12.7 mm) bead of sealant is applied over all curb seams and spread flat. The seams must be covered 1" (25.4 mm) either side of a seam.

! Curb connection notches must be cut to tightly fit select Fundo Riolito neo bases.

After Installation

All visible joints or seams in the installation are fully covered and reinforced with wedi Joint Sealant applied flat over the seams. Coverage of wedi Joint Sealant over all seams should be at least 1" (25.4 mm) on either side of the seam. The wedi Joint Sealant should be no less than 1/16" (1.6 mm) thick for strength. Do not add mesh tape into the wedi Joint Sealant. This may only put the waterproofing performance at risk and will not strengthen the sealant's or system's resistance against movement related stresses. Once wedi Joint Sealant application over all shower system seams has been completed, an optional water flood test may be performed as early as 2 hours later. The test should not exceed 24 hours and nor should the water level exceed the height of the perimeter seams so that the fresh sealant may continue to a full cure without too much weight added during that process. wedi recommends to test at least the drain connection for its proper seal while a full surface flood test is not technically required for non-absorbing products like wedi but may be required by a building inspection department. When tiling commences, no premixed and organic ("mastic") tile adhesives must be used over wedi Systems in any wet area installation. When tiling the wedi Shower Bases incl. extensions or ramps, tile thickness should generally not be less than 1/8" (3.2 mm). Choose setting materials appropriate for the type of stone, ceramic or glass tile as well as for a wet area installation. Tile with a square size of 2 x 2" (50.8 x 50.8 mm) or more may be installed using a polymer modified cement based tile adhesive and grout. Tile with a square size of less than 2 x 2" (50.8 x 50.8 mm) may be installed using a polymer modified cement based tile adhesive and require 100% solids epoxy grout. Tile with a square size of 1 x 1" (25.4 x 25.4 mm) or less must be installed using a 100% solids epoxy tile adhesive and grout. Only non-flat bottom pebble stone installations including in part small mosaics may be installed using polymer modified cement based tile adhesive and grout, all flat bottom pebble stone installation are subject to the general tile size based setting materials recommendation outlined above. When installing non-square tile, the length of the shortest tile edge(s) is considered as its square size for the purpose of determining the choice of the setting materials as outlined above. All tile installations designed to receive heavier point loads such as from wheelchair use, must be grouted using 100% solids epoxy grout. Large format tile may be installed over wedi Fundo shower bases. Cuts may have to be made in consideration of the base's slope lines and so that such tile can always be fully supported by the tile adhesive setting bed and the surface of the wedi Base. Tile adhesive coverage under the tile must be 95% and special care must be taken to achieve good transfer of adhesive to wedi's shower base when working with mesh backed tile. Use only solvent and acid free cleaners and sealers on tile and grout installed over wedi product and apply such products only in amounts as needed to treat the surface materials without drenching the substrate. Follow setting materials manufacturers recommendations and contact wedi with any questions or regarding applications not covered here.

Installation instructions wedi Fundo Riolito neo/Riolito neo Modular Drain Cover

01 Drain Cover Fundo Riolito neo standard: High Grade Polished Stainless Steel Standard Version

02 Drain Cover Fundo Riolito neo exclusive: High Grade Double Plated Stainless Steel Version

03 Drain Cover Fundo Riolito neo tileable: Can be tiled with epoxy glue/adhesive or wedi Joint Sealant. Can be used for 1/4" (6.4 mm) and 1/2" (12.7 mm) tile/stone (reverse cover). Drain cover can be adjusted from +3/16" to +1" from Riolito neo base surface (depth for tiling 11 mm). The cover supports may be extended out to needed height using the allen key included in box. The supports may also be cut shorter along prefabricated cutting lines before assembly with allen key.



Linear channel cover standard and exclusive

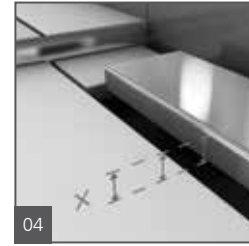
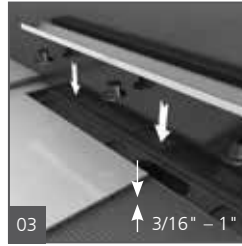

x = compressed thinset plus tile thickness + 1 mm.

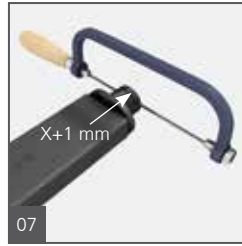

Linear channel cover tileable

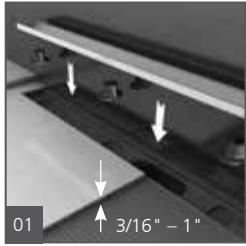

x = compressed thinset plus
tile thickness + 1 mm.

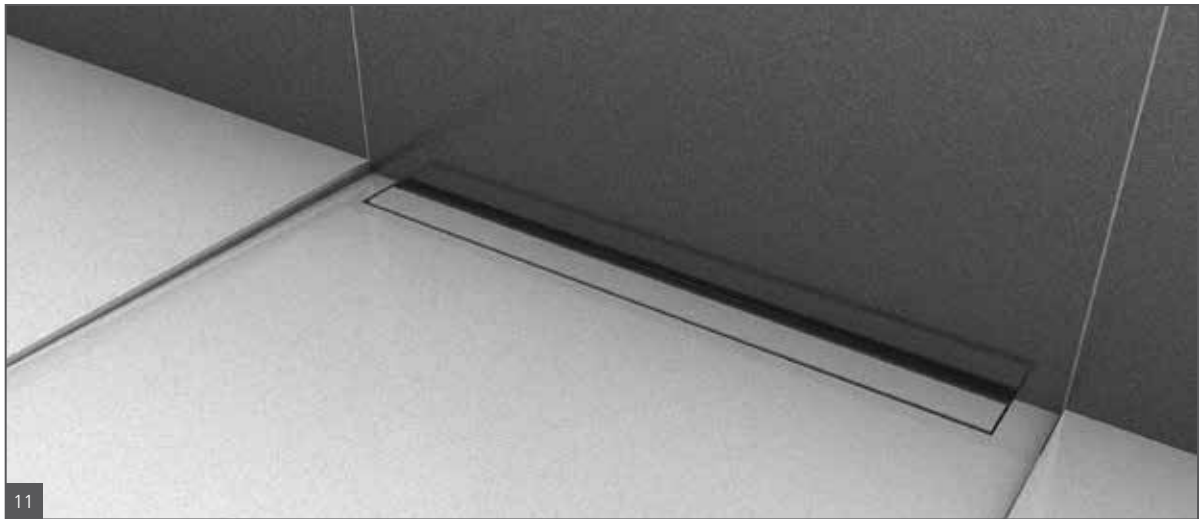
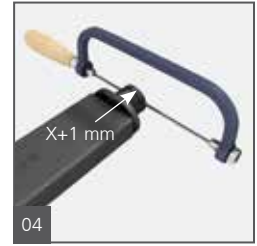

wedi Fundo Riolito neo Channel Frame

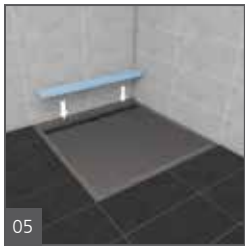
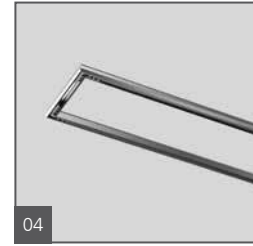
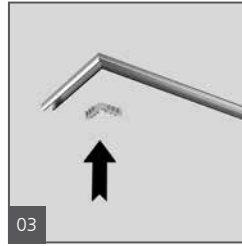
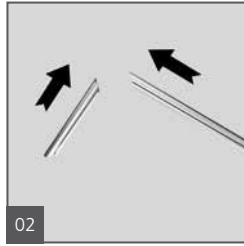
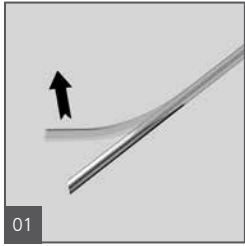

- i** Benefits of the wedi Fundo Riolito neo Channel frame include:
- Protects your tile and grout edges
 - Adds a design finish to the tile edge
 - Will not stop drainage
 - Made of stainless steel.

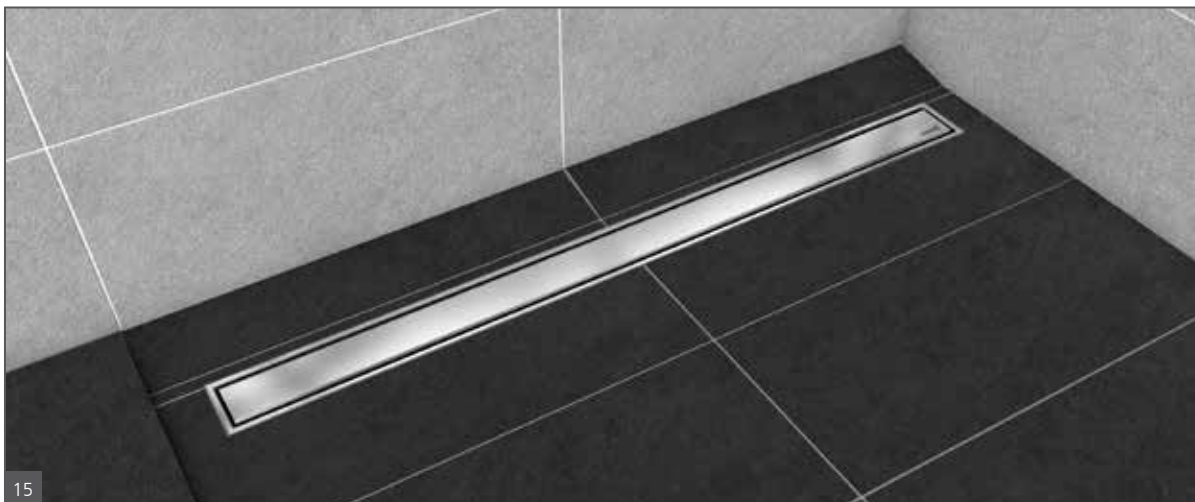



wedi Sanoasa® Shower Benches 1–5

While comfort means something different to each person, the feeling of quiet and relaxation when sitting in the shower can be a very pleasant experience for everyone. wedi Sanoasa benches provide plenty of space to comfortably relax, pampering both your body and mind in your own small wellness temple. The smart construction enables an unequal freedom of visual design; both the seating areas and the carrier elements can not only be positioned the way you like, but also their shapes and sizes can be modified to suit. The pre-sloped benches attach to shower wall and floor surfaces using wedi Joint Sealant or, where a gap opens to the floor due to a sloped shower floor, thinset is used to fill the gap and mesh tape is applied over the thinset application or floor to bench seam. These benches are prefabricated to save time versus building structures from scratch.

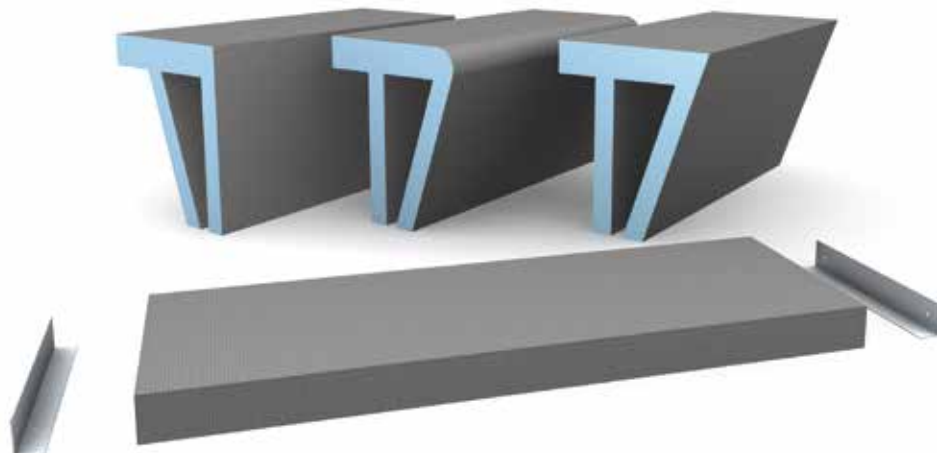



More wedi Prefabricated Shower Seats and Benches

wedi prefabricated shower seats and benches install much quicker and easier than metal tray or concrete seats. Plus, they bond well to thinset mortar and are 100% waterproof due to the extruded polystyrene closed cell foam core which is manufactured without the use of CFC and contains no HBCD. They will not cause efflorescence, discolorations or waterproofing issues as frequently observed with products including those requiring mortar fills. Now you can create the perfect waterproof seating solution for your shower. wedi Prefabricated Suspended Corner Seats do not require additional blocking installed in the framing. Their mounting brackets are fastened into existing wall studs. All non-suspended seats are pre-sloped on their seat surface. These benches are prefabricated to save time versus building structures from scratch.

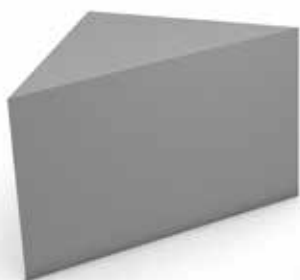

Specialty Applications – the wedi Building Panel as solution

Round and curved walls

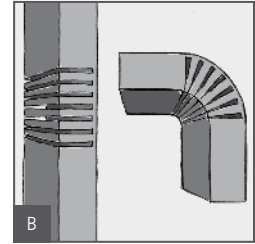
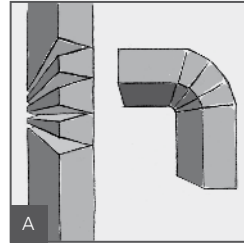
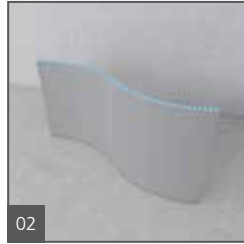
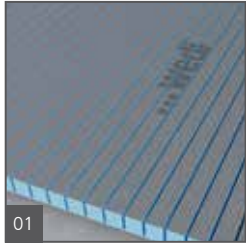

Create a series of cuts into the wedi Building Panels 1/2" the thickness of the panel deep. The distance between cuts depends on the tightness of the radius needed later. Use a circular saw for these cuts. A wide range of other shapes are possible using the wedi Building Panel. All you need is a template shaped to suit your needs. A template may not be needed for simpler shaping.

Cut the wedi Building Panel using a utility knife and straight edge. This way wave shape constructions can be produced. For a small radius – cut out wedges from the building panel or cut the wedi Building Panel using a hand-held circular saw and bend it into a curve.

wedi Vapor 85 – the wedi Building Panel for use in Steam Rooms and Steam Showers

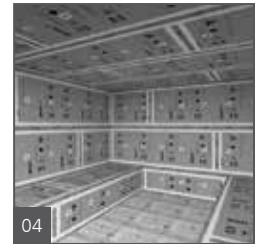
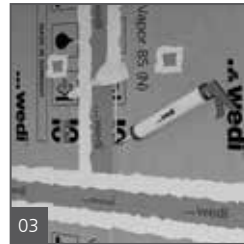

Ensure all framing and structures meet applicable wedi general requirements, building code and industry standards. Attach Vapor 85 panels to wall horizontally, and set the fasteners 1 ft. (304.8 mm) above shower floor. Use wedi's flat washers (washers without tabs) and screws. On solid or wedi built bench constructions (1 1/2" [38.1 mm] to 2" [50.8 mm] wedi Panels) install wedi Vapor 85 panels in well distributed 1/2" (12.7 mm) beads of wedi Sealant 620 spread with a space of 6" (152.4 mm) between beads. If the construction is not entirely smooth, use a full thinset mortar bed to attach using a 1/4" x 1/4" (6.4 x 6.4 mm) trowel. All panels are butted tightly with wedi Sealant 620 continuously applied between all contact seams. Excess sealant is spread flat with a putty knife. Use only wedi's flat washers so the membrane is not twisted upon tightening the washer. On ceilings, set wedi fasteners at a rate of 1 per every 6" (152.4 mm) of framing. In addition, apply a continuous 1/2" (12.7 mm) bead of wedi Sealant 620 on every stud before attaching the panel.

Apply several beads of wedi Sealant 620 as a setting and sealing bed for wedi sealing tape. Spread the sealant with a fine tooth adhesive trowel or flat putty knife to achieve a full coverage sealant bed for the sealing tape. The minimum thickness of the sealant bed should be 1/16" (1.5 mm). The tape is centered over the seams and pressed flat into the sealant. Make sure to use a flat putty knife or paint roller to

work the sealing tape flat over the seam and remove all air bubbles or any other unevenness. Excess sealant is spread flat. Sealing tape inside and outside corners, as well as collars for valves or other protrusions, are available.

Cover all fastener/ washer points with wedi Sealant 620 covering an area of 3" x 3" (76.2 x 76.2 mm) with the washer's screw at its center. Embed a sealing tape patch with a size of 2 1/2" x 2 1/2" (63.5 x 63.5 mm) into the bed of wedi Sealant 620 and press flat using a putty knife. Use wedi Sealant 620 and wedi Subliner sealing tape and sealing collars to seal around protrusions and penetrations of the Vapor 85 in the same method as using the same method as for applying tape and fastener point covers.

Allow the wedi Sealant 620 to cure for at least 24 hours prior to setting tile and 96 hours after its application before exposing the tiled installation to water and water vapor. On floor areas, consider wedi Fundo Shower Systems or Subliner Dry sheet waterproofing membrane when working over mortar or screed surfaces (install in accordance to Subliner Dry installation manual using wedi Sealant 620 in overlapping sheet – or Subliner Dry tape covered seam connections). When using Vapor 85 systems plan for needing one 20 oz. wedi 620 unit to install one wedi 3 x 8 x 1/2 in. Vapor 85 Building Panel, including seam tape and fastener patch installation.

Specialty Applications – the wedi Building Panel as solution

Building Custom Seats and Benches Using 1 1/2" (38.1 mm) or 2" (50.8 mm) thick wedi Building Panels

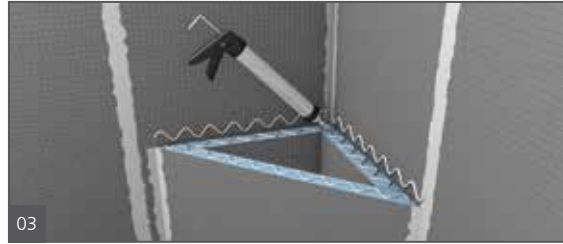
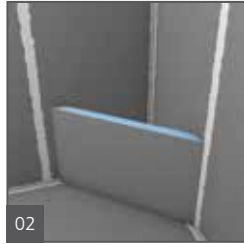
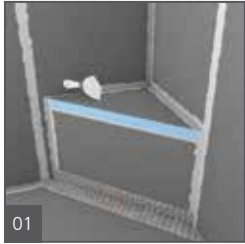

Measure and cut the bench pieces off a wedi 2" (50.8 mm) thick Building Panel and dry fit. When installing a corner seat, the panel edges are mitered for a tight fit. To achieve a slope, the part's upper ends are cut down with a slight angle towards the front of the bench. Optionally, create a pitch using wedi Joint Sealant as a "wet shim". The wedi parts are adhered to the wall using thinset mortar or wedi Joint Sealant. Adjoining parts are glued together using wedi Joint Sealant continuously applied along all foam edges of a panel part. Excess is spread flat over the seams using a putty knife. Where the part's backs meet the wedi wall, modified thinset mortar is used in a full contact surface bed. Once the bench is built, a final bead of wedi Joint Sealant is applied to safely seal all seams to the wedi wall. The vertical front part of the bench will show a small gap to the pitched floor. Please fill with thinset mortar and alkali resistant fiberglass mesh

tape by wedi, applied over this seam. Alternatively, benches and seats are offered as prefabricated units made by wedi. For longer or larger benches built from our 2" (50.8 mm) building panel, always install one spacer/support made of wedi 2" (50.8 mm) Building Panel every 18" (457 mm) in either direction. Over blue exposed foam edges please adhere a wedi Building Panel strip to foam using wedi Joint Sealant. This will create a cement based surface to adhere tile to it. Optionally, the blue foam may be covered with wedi Joint Sealant. The covering of the blue foam areas is not necessary, where tile is used that will overlap and cover the blue area with no more than 50% of its size. Such larger tile is thinset adhered to seat including the foam surface. The maximum weight allowance on seats or benches built with vertical supports placed every 18" (457 mm) o.c. is 500 lbs (227 kg).

Installation on tub walls



Measure and cut wedi Building Panel to fit the 16" (406.4 mm) o.c. framework (wood or metal). Notch out all panels if installed around the perimeter of a flange tub to integrate the flange and achieve a plumb wall with square and tight corners.

Attach a notched panel to the framework with a 1/2" (12.7 mm) bead of wedi Joint Sealant between the notch and flange. Attach the panel to the framework using wedi Washers and Screws at a rate of 1 every 12" (304.8 mm) along the studs. Leave a gap of 1/8" (3.2 mm) between tub edge and wedi Panel bottom end to allow for movement of the tub. Alternatively apply a bead of wedi Joint Sealant in between both materials.

Apply a continuous 1/2" (12.7 mm) bead of wedi Joint Sealant on the top blue foam edge of the wedi Building Panel before installing the next panel, butting tightly into the sealant. Set another wedi Washer and Screw into the seam to create a flush transition between panels and smooth over excess sealant. When installing a wedi side panel against the already fixed wedi back wall, apply a continuous 1/2" (12.7 mm) bead of wedi Joint Sealant vertically on the back wall wedi Panel where both panels will meet. Apply compression to the wedi Joint Sealant when moving the wedi side panel into position before fastening it. Finally and after all wedi Building Panels are installed a second 1/2" (12.7 mm) bead of wedi Joint Sealant is applied over all seams and fastener points and spread flat using a putty knife. On tubs or trays without or only partial nailing flange, use also wedi's tub sealing tape with its Butyl waterproofing strip.

Technical Properties ■ wedi Systems

Properties & Test Methods Value (wedi Building Panel and Fundo Shower System Components)		
ASTM C 578 *	Standard Specification for Rigid, Cellular Polystyrene	Compliant
Thermal Conductivity *	75°F (25°C) - ASTM C518	0.23 Bbtu in/hr F
R-Value *	75°F (25°) - ASTM C518	4.3hr ft. 2 F/Btu/in (R Value for 1" wedi = 4.3)
Tensile Strength ***	ASTM C297	65 psi
Shear Strength *	Under conditions required in ANSI A118.10-1999	28 day Shear Strength: 95 psi 84 day Shear Strength: 100 psi 100 day Shear Strength: 98 psi
Waterproof***	ASTM D4068 / ANSI A118.10-1999	Passed
Waterproofness of Assembly ***	ASTM E331	Passed, wedi Fundo Kit assembly (complete system)
Water Vapor Transmission****	ASTM E 96-2016	Permeance/Perms 0.03 and WVT (grains/h x ft ²) 0.05
Capillarity ***		0
Fungus / Bacteria Resistance ***	ASTM G21	Passed, No Growth
Flexural Strength *	ASTM C947	627 psi
Robinson Floor Test *	ASTM C627	Heavy duty commercial use, passed *
Fastener Pull Through *	ASTM C473	Wet 131.8 lb./Dry 196.2 lb.
Temperature Limits *		-58 / +175° F
Freeze & Thaw *	ASTM C666 - 25 Cycles	No disintegration/change
Accelerated Aging *	AC 71 - 25 Cycles	No disintegration
Linear Variation ***	AC 159/ASTM 1037-39	Passed, less than 0.07%
Surface Burning Characteristics *	ASTM E84-16 (NFPA 255, ANSI / UL 723, UBC 8-1) Tested as required without tile on Building Panel surface	Flame Spread Index (FSI): 20 Smoke Developed Index (SDI) : 70 Classification: Class A
Floor and Trench Drain Compliance **	ASME A112.18.2	Passed, Compliant (ICC PMG 1189)

* wedi Building Panel tested

** wedi Fundo Floor Systems tested

*** Entire wedi shower system tested

**** "Vapor 85 assembly incl. seams". Test standard is ASTM E 96 Method E at 100 F* and 90 % R.H.

* Consult wedi for proper subfloor, tile, setting materials choice to design heavy duty commercial use floor surfaces.

Weight for wedi Building Panels	Width	Length	Thickness	Weight
	3'	5'	1/4"	8.07 lb.
	3'	5'	1/2"	8.67 lb.

Approvals & Certificates				
Approvals and certificates applicable to entire Fundo Shower System incl. wedi Building Panel	City of New York, MEA 912-52-SM	Fundo Shower Systems & Building Panels: ICC PMG 1189 (for USA and Canada)	Meets all applicable ANSI/ISO Standards incl. ANSI 118.10 and IAPMO P5106	TCNA handbook recognized for wall, floor, countertop, & more applications
	City of Los Angeles Approval	BBA (British Board of Agrément)	DIN EN ISO 9001	CE marked
	Diverse State Approvals			
	SAI Global Watermark Certified (Australia & New Zealand)			
	Codemark Certified (Australia & New Zealand)			

Environmental Consideration
Contains no unbonded fire retardants like HBCD, and contains no ozone depleting and/ or greenhouse gases like CFC, HCFC, or HFC. *GWP: Measured is the impact from production of product over use through to disposal of product.

ICC-PMG 1189 Report ■ National Building Code Compliances

WEDI FUNDO SHOWER SYSTEM AND TILE BACKER BOARD UNDERLAYMENTS	
CSI	DIVISION: 22 00 00 – PLUMBING Section: 22 40 00 – Plumbing Fixtures (Shower System Kit)
Product certification system	The ICC-ES product certification system includes testing samples taken from the market or supplier's stock, or a combination of both, to verify compliance with applicable codes and standards. The system also involves factory inspections, and assessment and surveillance of the supplier's quality system.
Product	wedi Fundo Shower System and Tile Backer Board Underlayments
Listee	wedi Corporation 1160 Pierson Drive Batavia, IL 60510 www.wedicorp.com
Compliance with the following codes	2018, 2015, 2012 and 2009 International Plumbing Code® (IPC) 2018, 2015, 2012 and 2009 International Residential Code® (IRC) 2018, 2015, 2012 and 2009 International Building Code® (IBC) 2015, 2012 and 2009 National Standard Plumbing Code® (NSPC) 2015, 2012 and 2009 Uniform Plumbing Code® (UPC)* 2015, 2010 and 2005 National Plumbing Code of Canada** * Uniform Plumbing Code is a copyrighted publication if the International Association of Plumbing and Mechanical Officials ** National Plumbing Code of Canada is a copyrighted publication of National Research Council Canada
Compliance with the following standards	ANSI A 118.10-2014, Load Bearing, Bonded, Waterproof Membranes for Thin-Set Ceramic Tile and Dimension Stone Installations ASME A 112.6.3-2016, Floor and Trench Drains ICC-ES EG 159, Evaluation Guideline for Composite Backer Board (Approved Dec 2004) ASTM E 96-2016, Standard Test Methods for Water Vapor Transmission of Materials ASTM E 331-00(R16), ASTM E331-00(2016) Standard Test Method for Water Penetration of Exterior Windows, Skylights, Doors, and Curtain Walls by Uniform Static Air Pressure Difference ICC-ES AC 71, Acceptance Criteria for Foam Plastic Sheathing Panels Used as Water Resistive Barriers (Approved Feb 2003, Ed Revised Nov 2018) IAPMO PS 46-2012, Field-Fabricated Tiling Kits IAPMO PS 106-2015e1, Tileable Shower Receptors and Shower Kits
Identification	Packaging label for each system shall include the manufacturer's name or trademark as well as the ICC-ES PMG certification mark.
Installation	The wedi Fundo Shower Systems shall be installed in accordance with the manufacturer's published instructions and the applicable code(s). Shower system components shall be assembled and can be customized in the field. All shower bases and panels can be cut to size with hand saws or skill saws. Round curvy cuts can be made with a hand saw or jig saw. When provided drains must comply with ASME A112.18.2/CSA B125.2 as applicable. The wedi pre- sloped, ready-to-tile shower bases may be used in lieu of a CSA B45.5/IAPMO Z124 plastic shower receptors or any liner based shower installations. The wedi drain units do not require weep holes.
Listed Models and Characteristics	The wedi Fundo shower bases are waterproof, pre-sloped, ready-to-tile floor units. The waterproof wedi Building Panels are engineered as a general purpose backer board and underlayment for tile and consist of a rigid extruded polystyrene foam covered on both sides with a cement-based resin surface and reinforcing mesh for durability and bonding with any type of thinset mortar. The shower floors with linear and point drainage include factory sealed parts integrated into the floor base. Floor and wall system assembly and wedi components for shower installations were proven to be water- proof, water-resistant, and mold resistant when tested in accordance with A 118.10-2014. Shower system may include the following components: shower base, building panels, curbs, niches, seats, benches, ramps, vapor barrier, fasteners, cover plates, sealants, Fundo drains, Subliner sheet waterproofing membrane system with .Subliner Bonding Flange drain, wedi Building Panel Vapor 85 and sealing membrane Vapor 85 The wedi Fundo family line includes the following: Primo, Riolito neo, Riolito neo Modular, Riofino, Discreto, Ligno and Onestep.
Conditions of Listing	1. The wedi Fundo Shower Systems shall be installed in accordance with the manufacturer's published instructions and the applicable code(s). 2. The wedi Fundo Shower Systems are manufactured by wedi GmbH, in Emsdetten, Germany and in Batavia, Illinois, USA under a quality control program with annual surveillance inspections by ICC-ES.

wedi PRO Certification and 15/20 Year Warranty Program

20-year warranty for a
wedi bathroom system



15-year warranty for
a wedi shower system

In certain circumstances, in lieu of the foregoing 10-Year Limited Warranty, wedi offers a 15-Year Limited Warranty and 20-Year Limited Warranty, pursuant to which wedi warrants the products shall be free of manufacturing defects and conform to wedi's published specifications for a total of either 15-years or 20-years when installed as part of a "15-Year Warranty Installation" or "20-Year Warranty Installation," by a "PRO Certified Installer," in a "Registered Installation". Find Details on wedi's 15/20 Year Warranty Options on www.wedicorp.com.

- wedi's performance Shower Systems and its unprecedented warranty coverage and service meet great wedi installers
- Sign up for the wedi Pro Certification Classes – and enjoy wedi's 15 or 20-year full package warranty options



wedi Building Panel



Description	Width x Length x Thickness	Unit/Pallet	Item #	Retail Price
wedi Building Panel	3' x 5' x 1/4" (914 x 1524 x 6 mm)	25 panels = 375 sq. ft.	US8000005	\$53.86
wedi Building Panel	3' x 5' x 1/2" (914 x 1524 x 12.7 mm)	50 panels = 750 sq. ft.	010717064	\$55.87
wedi Building Panel	2' x 4' x 1/8" (600 x 1200 x 4 mm)	10 panels = 80 sq. ft.	US4000013	\$29.13
wedi Building Panel	3' x 5' x 5/8" (914 x 1524 x 15.8 mm)	50 panels = 750 sq. ft.	010716316	\$69.59
wedi Building Panel	2' x 8' x 1" (600 x 2500 x 25.4 mm)	25 panels = 400 sq. ft.	010719325	\$79.04
wedi Building Panel	2' x 8' x 3/4" (600 x 2500 x 20 mm)	50 panels = 800 sq. ft.	010000020	\$71.51
wedi Building Panel	2' x 8' x 1 1/4" (600 x 2500 x 30 mm)	36 panels = 576 sq. ft.	010000030	\$80.50
wedi Building Panel	2' x 8' x 1 1/2" (600 x 2500 x 40 mm)	36 panels = 576 sq. ft.	010000040	\$95.24
wedi Building Panel	2' x 8' x 2" (600 x 2500 x 50 mm)	24 panels = 384 sq. ft.	010000050	\$99.00
wedi Building Panel	2' x 8' x 3 1/15" (600 x 2500 x 80 mm)	12 panels = 192 sq. ft.	010710080 <small>(special order only)</small>	\$119.36
wedi Building Panel	2' x 8' x 3 9/10" (600 x 2500 x 100 mm)	20 panels = 320 sq. ft.	010710199 <small>(special order only)</small>	\$151.72

i Several sizes are available for ordering at smaller quantities upon request.

wedi Building Panel XL & XXL



Description	Width x Length x Height	Unit/Pallet	Item #	Retail Price
wedi Building Panel XL	3' x 8' x 1/2" (900 x 2500 x 12.5 mm)	26 panels = 624 sq. ft.	010000912	\$92.60
wedi Building Panel XXL	4' x 8' x 1/2" (1200 x 2600 x 12.5 mm)	50 panels = 1,600 sq. ft.	010001612	\$138.63
wedi Building Panel XXL	4' x 8' x 2" (1200 x 2500 x 50 mm)	12 panels = 396 sq. ft.	010001250	\$239.52

wedi Vapor 85 | Building Panel for Steam Rooms/Showers



Description	Width x Length x Height	Unit/Pallet	Item #	Retail Price
wedi Vapor 85	3' x 8' x 1/2" (900 x 2500 x 12.5 mm)	50 panels = 1,200 sq. ft.	010702912	\$159.00
wedi Vapor 85 Fastener Patch Kit	3" x 3" squares (76 mm x 76 mm)	100 pieces/bag	US5000089	\$19.58

wedi Shower and Bath Tub Surround Kit



Description	Kit Contents	Unit	Item #	Retail Price
wedi Shower and Bath Tub Surround Kit	(5) wedi 3' x 5' x 1/2" Building Panels (914 x 1524 x 12.7 mm) (5) wedi Joint Sealant, 10.5 oz. (310 ml) (1) Mixing Valve Flexi Collar (1) Flexi Collar (1) Corner Putty Knife 100 ct. of wedi Tab Steel Washers 100 ct. of wedi Galvanized Screws	1 kit	US4000001	\$371.49

! For Tub surrounds, Shower Wall Surrounds and use with Onestep Shower Bases.

Underlayment Kit

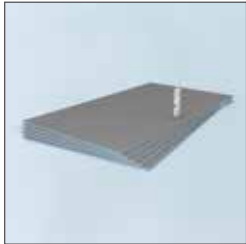

Description	Kit Contents	Unit	Item #	Retail Price
Underlayment Kit	(5) wedi 2' x 4' x 1/4" Building Panels (600 x 1250 x 6 mm) (1) wedi Joint Sealant, 10.5 oz. (30 cl) 40 x tabless washers and wood screws	1 kit	US4000002	\$180.67

! Especially for use with electric floor warming systems.

wedi Sealant 620



Description	Contents	Unit	Item #	Retail Price
wedi Sealant 620	10.5 oz (310 ml) cartridge	12 per case, full cases only	US5000088	\$28.00
wedi Sealant 620	20 oz (600 ml) sausage	20 per case, full cases only	US5000083	\$38.00

! Used to seal between overlapping Subliner Dry seams and to install and seal Subliner Dry sealing tape over seams. Also to be used with wedi Vapor 85 joint and fastener sealing in steam rooms using Subliner Dry sealing tape and tape for sealing purposes. Not used for adhering structure assembly components, for example when building custom seats (use wedi joint sealant).

wedi Fundo Primo® | Square and Rectangular Shower Bases, Center Drain

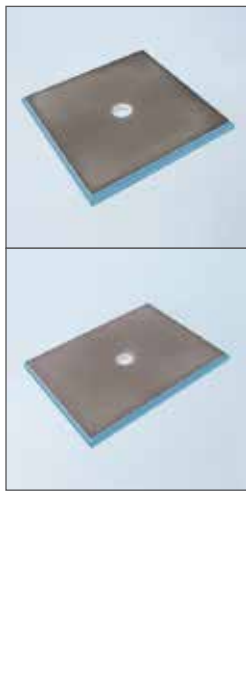

Description	Dimensions	Unit	Item #	Retail Price
wedi Fundo Primo, square	36" x 36" incl. drain (914 x 914 mm)	1 pc	073735507	\$469.98
wedi Fundo Primo, square	48" x 48" incl. drain (1220 x 1220 mm)	1 pc	073735505	\$651.37
wedi Fundo Primo, square	60" x 60" incl. drain (1524 x 1524 mm)	1 pc	073735518	\$1,161.18
wedi Fundo Primo, square	72" x 72" incl. drain (1830 x 1830 mm)	1 pc	073735524	\$1,705.35
wedi Fundo Primo, rectangular	36" x 48" incl. drain (914 x 1220 mm)	1 pc	073735516	\$598.84
wedi Fundo Primo, rectangular	36" x 60" incl. drain (914 x 1524 mm)	1 pc	073735506	\$639.82
wedi Fundo Primo, rectangular	48" x 60" incl. drain (1220 x 1524 mm)	1 pc	073735509	\$847.83
wedi Fundo Primo, rectangular	48" x 72" incl. drain (1220 x 1830 mm)	1 pc	073735508	\$1,003.32
wedi Fundo Primo, rectangular	60" x 72" incl. drain (1524 x 1830 mm)	1 pc	073735519	\$1,375.42
wedi Fundo Primo, rectangular	48" x 84" incl. drain (1220 x 2134 mm)	1 pc	073735522	\$1,319.72
wedi Fundo Primo, rectangular	60" x 84" incl. drain (1524 x 2134 mm)	1 pc	073735523	\$1,649.65
wedi Fundo Primo, rectangular	36" x 72" incl. drain (914 x 1830 mm)	1 pc	073735525	\$ 680.79
wedi Fundo Primo, rectangular	42" x 60" incl. drain (1066 x 1524 mm)	1 pc	073735527	\$768.06
wedi Fundo Primo, rectangular	42" x 72" incl. drain (1066 x 1830 mm)	1 pc	073735528	\$860.20

! wedi Fundo elements vary in thickness from 1 1/2" to 2" at the perimeter. When working with modular wedi Curbs or Ramps the connection notch might need to be adjusted in the field. Equipped with Drain Unit and Cover Set Brushed Stainless Steel.

wedi Fundo Primo® | Rectangular Shower Base, Offset Drain

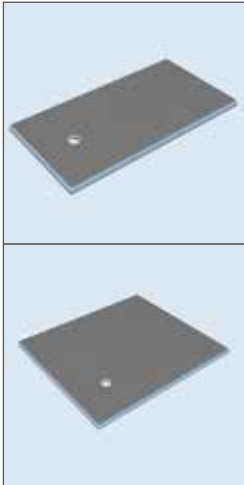
	Description	Dimensions	Unit	Item #	Retail Price
	wedi Fundo Primo, rectangular, offset drain	36" x 72" incl. drain (914 x 1830 mm)	1 pc	073735521	\$680.79
wedi Fundo Primo, rectangular, corner drain	60" x 72" incl. drain (1524 x 1830 mm)	1 pc	073735526	\$1,395.20	

! For tub replacement installations. Cut unit to always meet drain and shower size. Equipped with Drain Unit and Cover Set Brushed Stainless Steel.

wedi Fundo Primo® Shower Kit

	Description	Dimension	Unit	Item #	Retail Price
	wedi Fundo Primo Shower Kit	36" x 36" center drain (914 x 914 mm)	1 pc	US2000002	\$889.83
wedi Fundo Primo Shower Kit	36" x 48" center drain (914 x 1220 mm)	1 pc	US2000007	\$1,136.01	
wedi Fundo Primo Shower Kit	48" x 48" center drain (1220 x 1220 mm)	1 pc	US2000004	\$1,244.20	
wedi Fundo Primo Shower Kit	36" x 60" center drain (914 x 1524 mm)	1 pc	US2000003	\$1,177.62	
wedi Fundo Primo Shower Kit	36" x 72" center drain (914 x 1830 mm)	1 pc	US2000001	\$1,253.67	
wedi Fundo Primo Shower Kit	36" x 72" offset drain (914 x 1830 mm)	1 pc	US2000008	\$1,253.67	
wedi Fundo Primo Shower Kit	48" x 60" center drain (1220 x 1524 mm)	1 pc	US2000005	\$1,450.18	
wedi Fundo Primo Shower Kit	48" x 72" center drain (1220 x 1830 mm)	1 pc	US2000006	\$1,662.40	



- 1 wedi Fundo Pan
- wedi Building Panels to cover up to (3) 80" walls
- 1 drain assembly
- 1 Full Foam Curb Lean
- wedi Joint Sealant
- Fasteners
- wedi putty knife
- wedi Flexi Collar
- wedi Mixing Valve Flexi Collar

! Wall height 80"

wedi Fundo Ligno® | Square and Rectangular Shower Bases, Center Drain

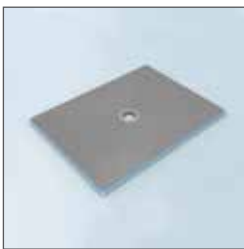
	Description	Dimensions	Unit	Item #	Retail Price
	wedi Fundo Ligno, square	36" x 36" x 3/4" (914 x 914 x 19 mm)	1 pc	073732010	\$585.00
wedi Fundo Ligno, square	48" x 48" x 3/4" (1220 x 1220 x 19 mm)	1 pc	073732015	\$803.40	
wedi Fundo Ligno, square	60" x 60" x 3/4" (1524 x 1524 x 19 mm)	1 pc	073732018	\$1,390.42	
wedi Fundo Ligno, rectangular	36" x 48" x 3/4" (914 x 1220 x 19 mm)	1 pc	073732014	\$745.56	
wedi Fundo Ligno, rectangular	36" x 60" x 3/4" (914 x 1524 x 19 mm)	1 pc	073732016	\$792.69	
wedi Fundo Ligno, rectangular	48" x 60" x 3/4" (1220 x 1524 x 19 mm)	1 pc	073732017	\$1,060.49	



wedi Fundo®/Pre-Sloped Extension Panels



Description	Width × Length × Thickness	Unit	Item #	Retail Price
Fundo Straight Extension Panel	48" × 24", sloped 1/4"/ft. (609.8 × 1219.2 mm, sloped 6 mm in 30 mm)	sheet	073783528	\$233.22
Fundo Straight Extension Panel "Lean"	72" × 12", sloped 1/4"/ft. (304.8 × 1828.8 mm, sloped 6 mm in 30 mm)	sheet	US3000036	\$174.00
Fundo Ligno Extension Panel	12" × 60", sloped 1/4"/ft. (304.8 × 1524 mm, sloped 6 mm in 30 mm)	sheet	US3000035	\$178.82

- ! Slope extends over 24" or 12" direction of either extension panel and pre-grooved
- Extension panels are designed to interlock with Fundo Primo bases and 4 way slope Fundo Riolito neo bases. The installation height must be increased if connected to Fundo and Ligno shower bases thicker than 1 1/2" at perimeter.

wedi Fundo® Drain Units & Kits Standard | Drain, PVC, ABS and Brass

Description	Unit	Item #	Retail Price
wedi Fundo Drain Kit Standard, ABS, Compression Fit	1 pc	US1000003	\$77.66
wedi Fundo Drain Kit; Brass, Compression Fit	1 pc	US1000004	\$92.39
wedi Fundo Glue Drain Kit, PVC	1 pc	US1000035	\$77.66
wedi Fundo Compression Fit Drain Unit	1 pc	US1000012	\$10.71
wedi Fundo Brass Compression Fit Drain Unit	1 pc	US1000011	\$32.96
wedi Fundo Glue Drain, PVC	1 pc	US1000034	\$13.39
wedi Angle Drain	1 pc	US1000027 (special order only)	\$117.34

- ! Drain Units connect to Schedule 40 pipe
- Compression Fit Drain units can be used with ABS/PVC pipe
- Glue Drain units can be used with ABS floor pipe
- Items sold as Kit contain Drain unit, extension collar and Cover Set standard
- For Fundo Primo and Ligno

wedi Fundo® Drain Accessories | 2" Sealing Gasket





Description	Unit	Item #	Retail Price
Special Rubber Caulking Gasket for Cast Iron Pipe Connection	1 pc	US5000030	\$18.09
Special Rubber Caulking Gasket for Copper Pipe Connection	1 pc	US5000031	\$18.09

- ! For use in Compression Fit Drain units
- Specialty Gaskets available upon request

wedi Fundo® Standard | Drain Cover, Stainless Steel Base

	Description	Width × Length	Unit	Item #	Retail Price
	wedi Fundo Drain Cover Set, Brushed Stainless Steel	4" × 4" (102 × 102 mm)	1 pc	US1000009	\$64.27
	wedi Fundo Drain Cover Set, Brushed Stainless Steel with Screws	4" × 4" (102 × 102 mm)	1 pc	US1000029	\$64.27
	wedi Fundo Drain Cover Set, Oil Rubbed Bronze	4" × 4" (102 × 102 mm)	1 pc	US1000008	\$70.97

-  For this drain cover, the height of your tiling must be at least 1/4".
 - For use with wedi Fundo Primo, Ligno bases.
 - The Standard Drain Cover included in Fundo Systems Primo/Ligno is US1000009
-  1 drain cover, stainless steel
 - 1 frame, stainless steel



wedi Fundo® Drain Wrench

	Description	Unit	Item #	Retail Price
	Heavy Duty Drain Wrench	1 pc	US5000032	\$16.07

 Support tool used to tighten wedi Fundo Primo compression fit rubber gaskets

wedi Fundo Fino® | Optional Design Covers, Stainless Steel Brushed

	Description	Unit	Item #	Retail Price
	Set 1.1 wedi Fundo Fino Cover Set 1.1, square 4" × 4" (102 × 102 mm) (Daisy Design)	1 pc	US1000021	\$110.00
Set 3.1 wedi Fundo Fino Cover Set 1.1.2, round (Daisy Design)	1 pc	US1000023	\$110.00	
Set 3.1 wedi Fundo Fino Cover Set 1.3, square 4" × 4" (102 × 102 mm) / w. Screws (Daisy Design)	1 pc	US1000022	\$110.00	
Set 3.1.2 wedi Fundo Fino Cover Set 3.1, square 4" × 4" (102 × 102 mm) (Pebbles Design)	1 pc	US1000024	\$110.00	
	wedi Fundo Fino Cover Set 3.1.2, round (Pebbles Design)	1 pc	US1000026	\$110.00
	wedi Fundo Fino Cover Set 3.3, square 4" × 4" (102 × 102 mm) / w. Screws (Pebbles Design)	1 pc	US1000025	\$110.00
	wedi Fundo Fino Tileable Cover Plate, square 4" × 4" (102 × 102 mm)	1 pc	US1000020	\$110.00
wedi Fundo Fino Tileable Cover Plate	wedi Fundo Fino Stainless Steel Cover, 4" × 4" (102 × 102 mm) / w. Screws	1 pc	US1000029	\$64.27

-  For use with wedi Fundo Primo, Ligno bases.
 - Tileable cover plate surface is elevated 1/16" over tile surface of a Fundo base. For a flush tile installation, wedi Joint Sealant spot bonding may be used to install the tile inside the cover so height is reduced versus the thinset bed build up under the tile on the shower base.
-  1 drain cover, stainless steel
 - 1 Frame, stainless steel

wedi Fundo Ligno® Recess Installation Kit

	Description	Dimension	Unit	Item #	Retail Price
	wedi Fundo Ligno Recess Installation Kit		5' x 5'	1 pc	US5000085
<p>! For a wedi Fundo Ligno Shower Base up to 60" x 60" (1524 x 1524 mm) in size.</p> <ul style="list-style-type: none"> 🔧 30 x C Brackets <ul style="list-style-type: none"> ▪ 60 x Coarse thread flat head Phillips wood screws ▪ 40 x Long flat head Phillips self-drilling screws with wings ▪ 160 x Short flat head Phillips self-drilling screws with wings ▪ 10 x Joist Brackets 					

wedi Fundo Riolito® neo | Shower Base, with Integrated Channel Drain

	Description	External Dimensions Length x Width x Height	Channel Length	Item #	Retail Price
	wedi Fundo Riolito neo, floor base, with channel drain		36" x 60" x 1 15/16" incl. drain, four-way slope (914 x 1524 x 51 mm)	43 5/16" (1100 mm)	075100016
wedi Fundo Riolito neo, floor base, with channel drain		48" x 60" x 2 9/16" incl. drain, four-way slope (1220 x 1524 x 63 mm)	27 1/2" (700 mm)	075100012	\$1,038.70
wedi Fundo Riolito neo, floor base, with channel drain		48" x 72" x 2 3/8" incl. drain, four-way slope (1220 x 1830 x 63 mm)	43 5/16" (1100 mm)	075100014	\$1,168.70
wedi Fundo Riolito neo, floor base, with channel drain		32" x 72" x (2 3/4" - 1 3/8") incl. drain, single slope (one-way slope) (813 x 1830 x 63 - 35.4 mm)	27 1/2" (700 mm)	075100015	\$830.00

wedi Fundo Riolito® neo Modular | Shower Base, with Integrated Channel Drain

	Description	External Dimensions Length x Width x Height	Channel Length	Item #	Retail Price
	wedi Fundo Riolito neo Modular, line module		32" x 5 3/4" (813 x 146 mm) Height Line Module: 1 3/8" (35.4 mm)	27 1/2" (700 mm)	075100052
wedi Fundo Riolito neo Modular, line module		48" x 5 3/4" (1220 x 146 mm) Height Line Module: 1 3/8" (35.4 mm)	43 5/16" (1100 mm)	075100053	\$360.00
wedi Fundo Riolito neo Modular, extension module		32" x 66 3/4" (813 x 1700 mm) Height Line Module: 1 3/8" (35.4 mm) - 2 3/16" (55.6 mm)	-	075100050	\$510.00
wedi Fundo Riolito neo Modular, extension module		48" x 66 3/4" (1200 x 1700 mm) Height Line Module: 1 3/8" (35.4 mm) - 2 3/16" (55.6 mm)	-	075100051	\$680.00

wedi Fundo Riolito® neo Shower Kit

	Description	Dimension	Unit	Item #	Retail Price
	wedi Fundo Riolito neo Shower Kit		32" x 72" One-Sided Slope (660 x 1830 mm)	1 pc	US4000010
<p>! Wall height 80"</p> <ul style="list-style-type: none"> ▪ Riolito neo Standard Drain Cover Plate included 🔧 1 wedi Fundo Shower Pan <ul style="list-style-type: none"> ▪ wedi Building Panels to cover up to (3) 80" walls ▪ 1 drain assembly ▪ 1 Full Foam Curb Lean ▪ Fasteners ▪ wedi Joint Sealant ▪ wedi Flexi Collar ▪ wedi Mixing Valve Flexi Collar ▪ wedi Riolito neo Standard Cover Plate 					

wedi Fundo Riolito® neo Standard | Cover Plate, Stainless Steel



Description	Width × Length × Height	Unit	Item #	Retail Price
wedi Fundo Riolito neo Standard drain cover for Riolito neo base 36" × 60" and 48" × 72" (914 × 1524 mm) and (1220 × 1830 mm), Riolito neo Modular 48" × 5 3/4" (1220 × 146 mm)	1 5/8" × 43 1/4" × 3/4" (41 × 1100 × 19 mm)	1 pc	676797045	\$190.00
wedi Fundo Riolito neo Standard drain cover for Riolito neo base 48" × 60" and 32" × 72" (1220 × 1524 mm) and (813 × 1830 mm), Riolito neo Modular 32" × 5 3/4" (813 × 146 mm)	1 5/8" × 27 5/8" × 3/4" (41 × 700 × 19 mm)	1 pc	676797048	\$146.00

! For tile installation heights of between 3/16" to 1"
For Fundo Bases Riolito neo and Riolito neo Modular.

wedi Fundo Riolito® neo Exclusive | Cover Plate, Stainless Steel



Description	Width × Length × Height	Unit	Item #	Retail Price
wedi Fundo Riolito neo Exclusive drain cover for Riolito neo base 36" × 60" and 48" × 72" (914 × 1524 mm) and (1220 × 1830 mm), Riolito neo Modular 48" × 5 3/4" (1220 × 146 mm)	1 5/8" × 43 1/4" × 3/4" (41 × 1100 × 19 mm)	1 pc	676797046	\$388.70
wedi Fundo Riolito neo Exclusive drain cover for Riolito neo base 48" × 60" and 32" × 72" (1220 × 1524 mm) and (813 × 1830 mm), Riolito neo Modular 32" × 5 3/4" (813 × 146 mm)	1 5/8" × 27 5/8" × 3/4" (41 × 700 × 19 mm)	1 pc	676797049	\$357.50

! For tile installation heights of between 3/16" to 1"
For Fundo Bases Riolito neo and Riolito neo Modular.

wedi Fundo Riolito® neo Tileable | Cover Plate, Stainless Steel



Description	Width × Length × Height	Unit	Item #	Retail Price
wedi Fundo Riolito neo Tileable drain cover for Riolito neo base 36" × 60" and 48" × 72" (914 × 1524 mm) and (1220 × 1830 mm), Riolito neo Modular 48" × 5 3/4" (1220 × 146 mm)	1 5/8" × 43 1/4" × 3/4" (41 × 1100 × 19 mm)	1 pc	676797047	\$388.70
wedi Fundo Riolito neo Tileable drain cover for Riolito neo base 48" × 60" and 32" × 72" (1220 × 1524 mm) and (813 × 1830 mm), Riolito neo Modular 32" × 5 3/4" (813 × 146 mm)	1 5/8" × 27 5/8" × 3/4" (41 × 700 × 19 mm)	1 pc	676797050	\$357.50

! For tile installation heights of between 3/16" to 1".
Reverse for thinner or thicker tile.
For Fundo Bases Riolito neo and Riolito neo Modular.

wedi Fundo Riolito® neo Channel Frame



Description	Width × Length × Height	Unit	Item #	Retail Price
wedi Fundo Riolito neo Channel Frame for 28" (700 mm) channel	2.5" × 28" × 0.25" (63 × 700 × 30 mm)	1 pc	676800061	\$140.16
wedi Fundo Riolito neo Channel Frame for 43.75" (1100 mm) channel	2.5" × 43.75" × 0.25" (63 × 1100 × 30 mm)	1 pc	676800064	\$153.42

! For use with wedi Fundo Riolito neo and Riolito neo Modular bases with 700 mm and 1100 mm channel
Made of Brushed Stainless Steel

wedi Fundo Discreto® | System Component, for Creating Vertical Wall Drainage



Description	External Dimensions Length x Width x Height	Unit	Item #	Retail Price
wedi Fundo Discreto System Component, channel length 31.5" (700mm), Integrates into wedi seats, tileable cover included	35 2/5" x 6" x 3 1/15" (900 x 154 x 80 mm)	1 pc	073738206	\$933.06
wedi Fundo Discreto System Component, channel length 43.75" (1100 mm) Integrates into wedi seats, tileable cover included	47 1/4" x 6" x 3 1/15" (1200 x 154 x 80 mm)	1 pc	073738209	\$1,015.92

i For installation over wedi Fundo Riolito neo 48" x 60" or 32" x 60" bases

wedi OneStep Shower System



Description	External Dimensions Length x Width x Height	Unit	Item #	Retail Price
wedi OneStep Shower Base	36" x 36" x 4", center drain (914 x 914 x 102 mm)	1 pc	US4000004	\$698.00
wedi OneStep Shower/Tub Replacement Base	36" x 60" x 4", left drain (914 x 1524 x 102 mm)	1 pc	US4000006	\$860.00
wedi OneStep Shower/Tub Replacement Base	36" x 60" x 4", right drain (914 x 1524 x 102 mm)	1 pc	US4000007	\$860.00

i Custom Sizes available on request

wedi Curb Over

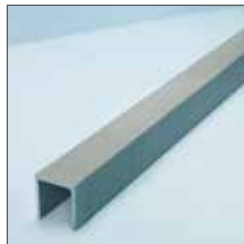

Description	Width x Length x Height	Unit	Item #	Retail Price
wedi Curb Over (Square Edges)	4 1/2" x 5' x 5" (114 x 1524 x 127 mm)	1 pc	US3000008	\$80.57
wedi Curb Over (Square Edges)	4 1/2" x 8' x 5" (114 x 2500 x 127 mm)	1 pc	US3000010	\$115.73

! Installation over 2" x 4" construction. CAUTION: Do not allow Glass Door Assembly to penetrate Curb Over.

wedi Full Foam Curb

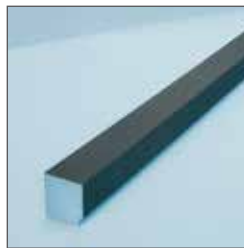

Description	Width x Length x Height	Unit	Item #	Retail Price
wedi Curb Full Foam (Square Edges)	4 1/2" x 3' x 5" (114 x 914 x 127 mm)	1 pc	074319009	\$58.55
wedi Curb Full Foam (Square Edges)	4 1/2" x 5' x 5" (114 x 1524 x 127 mm)	1 pc	074319002	\$94.68
wedi Curb Full Foam (Square Edges) Master Pack	4 1/2" x 5' x 5" (114 x 1524 x 127 mm)	6 pc	US3000030	\$568.00
wedi Curb Full Foam (Square Edges)	4 1/2" x 8' x 5" (114 x 2500 x 127 mm)	1 pc	074319001	\$138.84

! Sloped on top surface

wedi Full Foam Curb "LEAN"

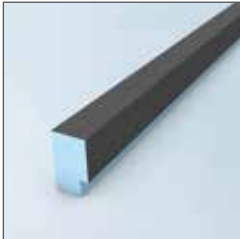

Description	Width × Length × Height	Unit	Item #	Retail Price
wedi Full Foam Curb "LEAN" (Square Edges)	2" × 5' × 3 1/2" (51 × 1524 × 89 mm)	1 pc	074319007	\$50.18
wedi Full Foam Curb "LEAN" (Square Edges) Master Pack	2" × 5' × 3 1/2" (51 × 1524 × 89 mm)	6 pc	US3000031	\$301.06
wedi Full Foam Curb "LEAN" (Square Edges)	2" × 8' × 3 1/2" (51 × 2438 × 89 mm)	1 pc	074319008	\$80.29

! Sloped on top surface

wedi Shower Ramp

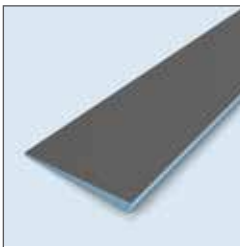

Description	Width × Length × Height	Unit	Item #	Retail Price
wedi Shower Ramp*	16" × 5', sloped 1 1/2" to 1/4" (406.4 × 1524 mm, sloped 38.1 to 6.35 mm)	1 pc	073736517	\$223.73

! * ADA compliant

wedi Niche | Square Edges



Description	Dimension	Unit	Item #	Retail Price
wedi Niche Square Edges	16" × 8" (406 × 203 mm)	1 pc	US3000003	\$52.53
wedi Niche Square Edges	16" × 12" (406 × 305 mm)	1 pc	US3000004	\$65.20
wedi Niche Square Edges	16" × 16" (406 × 406 mm)	1 pc	US3000005	\$67.24
wedi Niche Square Edges	16" × 22" (406 × 559 mm) incl. removable shelf	1 pc	US3000007	\$83.84
wedi Lean Combo Niche	16" × 42" (406 × 1067 mm) incl. 2 removable shelves	1 pc	US3000024	\$144.77
wedi Cathedral Niche	16" × 30" (406 × 762 mm) incl. removable shelf	1 pc	US3000016	\$100.98

! Installation over 2" × 4" construction, 16" o.c. framework.
Dimensions are outside dimensions.

wedi Shower Seat M & L



Description	Width × Length × Height	Unit	Item #	Retail Price
wedi Seat M, Suspended Seat	17" × 17" (wall sides) × 4" (432 × 432 × 102 mm)	1 pc	US3000001	\$139.00
wedi Seat L, Suspended Seat	24" × 24" (wall sides) × 4" (610 × 610 × 102 mm)	1 pc	US3000002	\$159.00

wedi Bench | Rectangular and Full Foam Triangular Seats

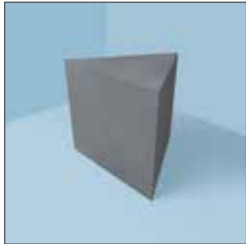

Description	Width × Length × Height	Unit	Item #	Retail Price
wedi Full Foam Corner Seat	23" × 23" (wall sides) × 20" sloped (584 × 584 × 508 mm)	1 pc	073784101	\$270.00
<p>! Rectangular bench made with 2" wedi Building Panel, full foam corner seat made of solid XPS foam. These units are pre-made and ready for thinset installation against walls and feature a 1/8" slope to the front.</p>				

wedi Sanoasa® Bench 1



Description	Length × Height × Depth	Unit	Item #	Retail Price
wedi Sanoasa Bench 1 M	approx. 35" × 18" × 15" (900 × 454 × 380 mm)	1 pc	076447030	\$505.47
wedi Sanoasa Bench 1 L	approx. 47" × 18" × 15" (1200 × 454 × 380 mm)	1 pc	076447031	\$606.97
<p>!</p> <ul style="list-style-type: none"> The bench is delivered in four parts: Bench element, substructure element and 2 side elements wedi Joint Sealant is included for adhesion wedi Fiberglass Mesh Tape is included for the wall/floor connection 				

wedi Sanoasa® Bench 2

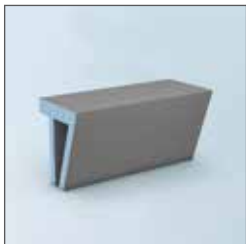

Description	Length × Height × Depth	Unit	Item #	Retail Price
wedi Sanoasa Bench 2 M	approx. 35" × 18" × 15" (900 × 454 × 380 mm)	1 pc	076447032	\$505.47
wedi Sanoasa Bench 2 L	approx. 47" × 18" × 15" (1200 × 454 × 380 mm)	1 pc	076447033	\$606.97
<p>!</p> <ul style="list-style-type: none"> The bench is delivered in four parts: Bench element, substructure element and 2 side elements wedi Joint Sealant is included for adhesion wedi Fiberglass Mesh Tape is included for the wall/floor connection 				

wedi Sanoasa® Bench 3

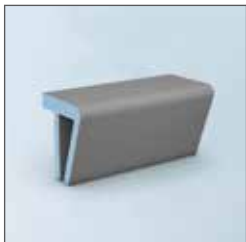

Description	Length × Height × Depth	Unit	Item #	Retail Price
wedi Sanoasa Bench 3 M	approx. 35" × 18" × 15" (900 × 454 × 380 mm)	1 pc	076447034	\$505.47
wedi Sanoasa Bench 3 L	approx. 47" × 18" × 15" (1200 × 454 × 380 mm)	1 pc	076447035	\$606.97
<p>!</p> <ul style="list-style-type: none"> The bench is delivered in four parts: Bench element, substructure element and 2 side elements wedi Joint Sealant is included for adhesion wedi Fiberglass Mesh Tape is included for the wall/floor connection 				

wedi Sanoasa® Shower Bench 4



Description	Length × Depth × Height	Unit	Item #	Retail Price
wedi Sanoasa Shower Bench 4, straight	47 1/4" × 15" × 3 1/8" (1200 × 380 × 80 mm)	1 pc	US3000000	\$343.07
<p>i</p> <ul style="list-style-type: none"> wedi Joint Sealant is included for adhesion wedi Fiberglass Mesh Tape is included for the wall/floor connection 				

wedi Sanoasa® 5 Floating Bench



Description	Length × Depth × Height	Unit	Item #	Retail Price
wedi Sanoasa Floating Bench	59" x 17 7/10" x 3 9/10" (1500 x 450 x 100 mm)	1 pc	076400760 (special order only)	\$1,806.09
wedi Sanoasa Floating Bench	78" x 17 7/10" x 3 9/10" (2000 x 450 x 100 mm)	1 pc	076400760 (special order only)	\$2,193.11
wedi Sanoasa Floating Bench	98" x 17 7/10" x 3 9/10" (2500 x 450 x 100 mm)	1 pc	076400760 (special order only)	\$2,580.12
wedi Sanoasa Floating Bench	118" x 17 7/10" x 3 9/10" (3000 x 450 x 100 mm)	1 pc	076400760 (special order only)	\$2,967.14
wedi Sanoasa Floating Bench, Corner element	17" x 17 7/10" x 3 9/10" (450 x 450 x 100 mm)	1 pc	076400761 (special order only)	\$1,290.06

wedi Subliner® Dry | Waterproofing Sheet Membrane



Description	Width × Roll Length	Unit	Item #	Retail Price
wedi Subliner Dry Mat (waterproofing)	39" × 16' (1 × 5 m)	1 roll	US5000001	\$97.10
wedi Subliner Dry Mat (waterproofing)	39" × 98' (1 × 30 m)	1 roll	US5000005	\$544.31
wedi Subliner Dry Waterproof Sealing Tape	5" × 32.8' (127 mm × 10 m)	1 roll	US5000002	\$46.59
wedi Mixing Valve Flexi Collar	Ø 5" (Ø 127 mm)	1 piece	US5000000	\$15.97
wedi Flexi Collar, for sealing around 1/2" to 3/4" shower pipe protrusions	4 3/4" × 4 3/4" (115 × 115 mm)	1 piece	US5000033	\$13.16
Subliner Dry Sealing Tape Inside Corner	4 3/4" × 4 3/4" × 2 1/4" (115 × 115 × 57.15 mm)	1 pack/ 2 pieces	US5000007	\$15.60
Subliner Dry Sealing Tape Outside Corner	4 3/4" × 4 3/4" × 2 1/4" (115 × 115 × 57.15 mm)	1 pack/ 2 pieces	US5000008	\$15.60

! Flexible waterproofing membrane for medium and high exposure wet areas – for interior walls/showers and steam showers.

wedi Accessories | wedi Tub Sealing Tape with Waterproof Butyl Connection Strip



Description	Width × Roll Length	Unit	Item #	Retail Price
wedi Tub Sealing Tape with Waterproof Butyl Connection Strip	4.72" × 11.8" (120 mm × 3.6 m)	1 roll	US5000084	\$55.12



wedi Joint Sealant | MS Polymer Sealant and Adhesive



Description	Contents	Unit	Item #	Retail Price
wedi Joint Sealant, MS polymer sealant	10.5 oz. (310 ml)	1 Cartridge	US5000013	\$16.71
wedi Joint Sealant, MS polymer sealant	20 oz. (519.5 ml)	1 Sausage	US5000010	\$27.79

! Permanently flexible, waterproof sealant and adhesive for joint treatment.

wedi Sausage Gun | Gun for MS Polymer Sealant Sausages and Replacement Tips

	Description	Unit	Item #	Retail Price
	wedi Sausage Gun, gun for wedi joint MS polymer sealant sausages	1 piece	US5000019	\$78.28
	wedi Sausage Gun Replacement Tip	per piece	US5000020	\$1.09
	<p>i For use with 20 oz. sausages and 10 oz. tubes.</p>			

wedi Tools | Corner Putty Knife

	Description	Unit/Bag	Item #	Retail Price
	wedi Tools, corner putty knife for wedi shower system installations	1 pc	US5000044	\$4.69
	<p>i Use to smooth out wedi Joint Sealant applications.</p>			

wedi Fastener Kit

	Description	Length	Unit	Item #	Retail Price
	wedi Fastener Kit	100 wedi Coarse Thread Screws 1 5/8" 100 wedi Tab Steel Washers	1 piece	US5000070	\$31.20
	wedi Tabless Washer Fastener Kit	100 wedi Coarse Thread Screws 1 5/8" 100 wedi Tabless Steel Washers	1 piece	US5000086	\$31.20
	<p>i Phillips head for wood studs, premium ceramic coating (ACQ Compliant). For installation to wooden and metal framework (20 gage). Tabbed washers provide four tabs for fast and secure placement. wedi Washers provide a solid gauge according to ISO standards and less potential for deformation. Load capabilities are independently tested.</p>				

wedi Accessories | Thread Screws

	Description	Length	Unit/Box	Item #	Retail Price
	Coarse thread screws, ceramic coating,	1 5/8" (41.5 mm)	1000 pcs	US5000012	\$91.86
	Fine thread self-tapping zinc coated	1 1/4" (31.75 mm)	100 pcs	US5000018	\$21.92

i Phillips head for wood studs, premium ceramic coating (ACQ Compliant). For installation to wooden and metal framework (20 gage).
For installation to metal framing 18 ga. or heavier.

wedi Accessories | Tab Steel Washers, Galvanized

	Description	Diameter	Unit/Box	Item #	Retail Price
	Tab Steel Washers, Galvanized	1 1/4" (31.75 mm)	1000 pcs	US5000009	\$140.26
	<p>i Tabbed washers provide four tabs for fast and secure placement. wedi Washers provide a solid gauge according to ISO standards and less potential for deformation. Load capabilities are independently tested.</p>				



- Hospitality
- Health Care
- Universities
- Dormitories

wedi Custom Wellness & Spa Design Solutions

Starting a new custom project, residential or commercial steam room? Do you need custom loungers? From idea to installation, you have our promise that wedi will support you right from the start. The moment you contact us, our team springs into action. We generate custom CAD drawings based upon your ideas and plans. We produce custom products fabricated from impermeable extruded polystyrene foam material exclusively for steam showers and wet rooms. We test all the assemblies to ensure everything works flawlessly before we supply you with all the components, ready to install. We understand products are just part of the project. That's why we create and work in tandem with your lighting concepts, heating systems and preferred shower technologies.

wedi is at your side – in all areas, at all times.

- **Your idea** – As you envision your wellness concept, contact wedi and we can help bring your idea to life.
- **We plan together** – wedi provides integrated project planning to ensure all components, shower technologies, drains and supply pipes are incorporated into your vision and unified for proper performance.
- **Made-to-measure products** – With your approval, we produce solutions that fit your specifications and requirements perfectly. Then we assure the system measures up in terms of performance through trial assemblies at our factory all prior to shipping.
- **On time delivery** – We deliver all prefabricated components on time and in their entirety, with complete step-by-step assembly instructions so you can take your idea and bring it to life!





Did you know?

Great quality installation results depend on not only having great products to use – the Know-How and Experience in how to use them is key too. We have trained a variety of installers around the country and now they fully know and appreciate what they can achieve with wedi.

This educational service is offered to all professional contractors of all trades and wedi's local Technical Sales Support Managers come out on site and install with you when you do your first wedi shower installation. Your peace of mind – at no charge. Just a call away!

wedi is a proud member of:



Be sure to ask for:



Follow us on:

Instagram: @wedicorp

www.youtube.com/wedicorp

www.facebook.com/wedicorp

Certified wedi Installer

wedi-quality and performance certified by:



Serving USA and Canada



wedi Corporation

Tel. +1-847-357-9815

Fax. +1-847-357-9819

info@wedicorp.com

www.wedicorp.com



Made in USA

