

# INSTALLATION INSTRUCTIONS

## CHOOSE THE PROPER LOCATION

### ⚠ WARNING

- **The washer is heavy. Two or more people are required when moving and unpacking the washer.** Failure to do so may result in damage to property or serious bodily harm.
- **Store and install the washer where it will not be exposed to temperatures below freezing or exposed to outdoor weather conditions.** Failure to follow this warning can cause serious injury, fire, electric shock, or death.
- **Properly ground the washer to conform with all electric governing codes and ordinances.** Failure to follow this warning can cause serious injury, fire, electric shock, or death.
- **To reduce the risk of electric shock, do not install the washer in humid spaces.** Failure to follow this warning can cause serious injury, fire, electric shock, or death.
- **To ensure proper air flow, do not block the large opening on the bottom of the washer with carpeting or other materials.**
- **Do not remove ground prong. Do not use an adapter or extension cord. Plug into a grounded 3-prong outlet.** Failure to follow this warning can cause serious injury, fire, electric shock, or death.

## POWER OUTLET

- The power outlet must be within 60 in. (1.5 m) of either side of the washer.
- The appliance and outlet must be positioned so that the plug is easily accessible.
- Do not overload the outlet with more than one appliance.
- The outlet must be grounded in accordance with current wiring electric codes and regulations.
- Time-delay fuse or circuit breaker is recommended.

**NOTE:** It is the personal responsibility and obligation of the product owner to have a proper outlet installed by a qualified service technician.

## FLOORING

- To minimize noise and vibration, the washer **MUST** be installed on a solidly constructed floor.
- Allowable slope under the entire washer is a maximum 1 inch. difference from side to side or from front to back.
- Installing on carpeting and soft tile surfaces is not recommended.
- Never install the washer on a platform or weakly supported structure.

**NOTE:** The washer must be installed on firm flooring to minimize vibration during the spin cycle. Concrete flooring is best, but a wood floor is sufficient, provided it is built to FHA standards. The washer should not be installed on rugs or exposed to weather.

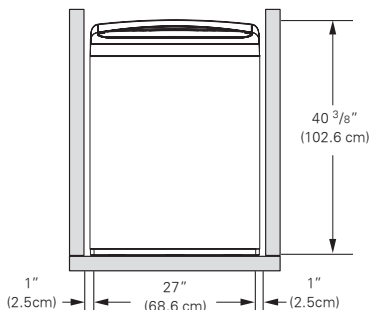

To ensure sufficient clearance for water lines and airflow, allow minimum clearances of at least 1 in. (2.5 cm) at the sides and 4 in. (10 cm) behind the unit. Be sure to allow for wall, door, or floor moldings that may increase the required clearances.

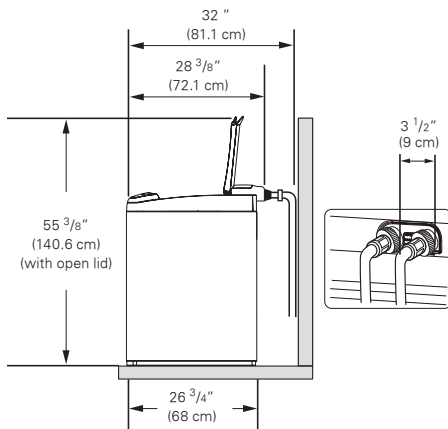

Minimum vertical space from floor to overhead shelves, cabinets, ceilings, etc., is 56 in.

## UNPACKING AND REMOVING SHIPPING MATERIAL

1. After removing the carton and shipping material, lift the washer off the foam base. Make sure the plastic tub support comes off with the base and is not stuck to the bottom of the washer.

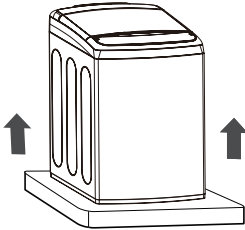

If you must lay the washer down to remove the base packaging materials, always protect the side of the washer and lay it carefully on its side. DO NOT lay the washer on its front or back.

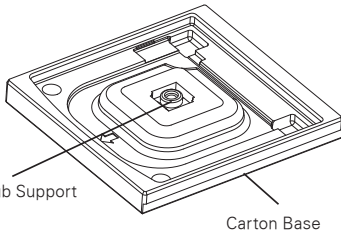

2. Save the foam block (that contains the Owner's Manual, parts and laundry product samples) for future use. If the washer must be moved in the future, the foam block will help prevent damage to the washer during transportation.

**NOTE:** To prevent damage, do not remove the foam block until the washer is at the final location.

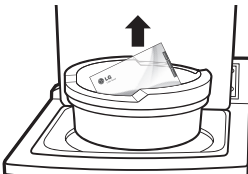

3. Carefully remove the two foam pads which cover the top sides of the tub guide, making sure not to leave behind any pieces of the foam.

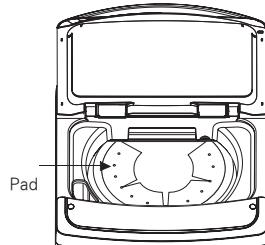

4. Unfasten the power cord from the back of the washer.

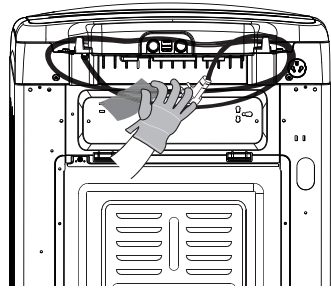

## TOOLS YOU WILL NEED

- Adjustable Pliers

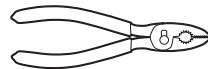

- Carpenter's Level



## CONNECTING THE WATER LINES

- LG recommends the use of LG hoses. Any leaking, property damage, or damage to the washing machine caused by an improper installation or by the use of non-LG hoses is not covered under the terms of the LG warranty and is the sole responsibility of the customer and/or an installer.
- Water supply pressure must be between 20 psi and 120 psi (138~827 kPa). If the water supply pressure is more than 120 psi, a pressure reducing valve must be installed.
- Periodically check the hose for cracks, leaks, and wear, and replace the hose if necessary.
- Make sure that the water lines are not stretched, pinched, crushed, or kinked.
- The washer should never be installed or stored in a location subject to freezing temperatures. Damage to the water lines and internal mechanisms of the washer can result. If the washer was exposed to freezing temperatures prior to installation, allow it to stand at room temperature for several hours before use and check for leaks prior to operation.

**NOTE:** Do not use flood-preventing hoses with auto shutoff devices. The devices can be tripped during fill and prevent the machine from filling properly.

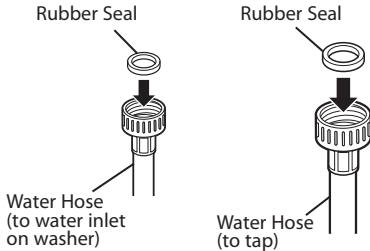

1. Inspect the threaded fitting on each hose and make sure there is a rubber seal in place in both ends of each hose.

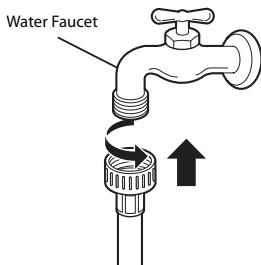

### ⚠ WARNING

- **Do not reuse old hoses.** Only use new hoses when you install the washing machine. Old hoses could leak or burst causing flooding and property damage.

2. Connect the water supply hoses to the HOT and COLD water faucets tightly by hand and then tighten another 2/3 turn with pliers.

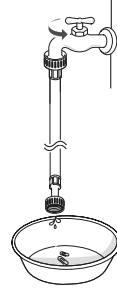

### ⚠ WARNING

- **Do not overtighten.** Damage to the coupling can result.

3. Always run a gallon or two of water through each inlet hose to flush dirt, scale and other debris out of the water lines. Doing so will help prevent future problems with clogged filter screens, and will also allow you to verify which water line is hot and which is cold.

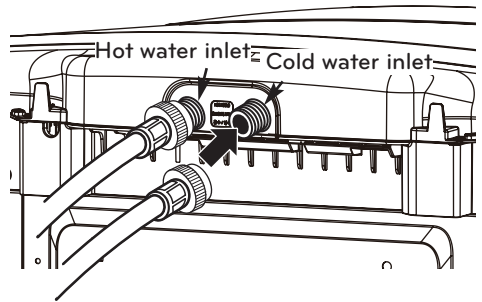

### ⚠ WARNING

- **Do not overtighten the hoses.** Overtightening can damage the valves resulting in leaking and property damage.

4. Attach the hot water line to the hot water inlet on the back of the washer. Attach the cold water line to the cold water inlet on the back of the washer. Tighten the fittings securely. Turn ON both faucets all the way and check for leaks at both ends of the hoses.

**NOTE:** Be careful not to cross-thread the hose fittings. This will damage the valve and could result in property damage from leaks.

## CONNECTING THE DRAIN HOSE

- The drain hose should always be properly secured. Failure to properly secure the drain hose can result in flooding and property damage.
- The drain must be installed in accordance with any applicable local codes and regulations.
- Make sure that the drain hose is not stretched, pinched, crushed, or kinked.

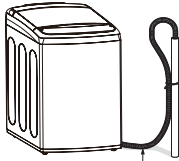

Drain Hose

### OPTION 1: STANDPIPE

Bend the outlet end of the drain hose to form a U shape. Insert the end of the drain hose into the drain. If the drain is large enough for the flange on the hose to fit inside, then do not insert the flange more than 1-2 inches into the drain. Use the tie strap included with the installation materials in the foam block in the tub to secure the drain hose to the drain.

If the water valves and drain are built into the wall,

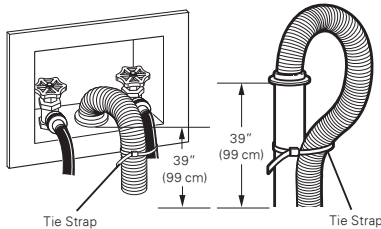

Tie Strap

Tie Strap

fasten the drain hose to one of the water hoses with the tie strap (ribbed side on inside).

If your drain is a standpipe, fasten the drain hose to the standpipe with the tie strap provided.

### NOTE:

- Normal height of the end of the hose should be approximately 35"~47" (0.9~1.2 m) from the floor.
- Do not install the end of the drain hose lower than 29 in. (73.7 cm) or higher than 96 in. (243.8 cm) above the bottom of the washer or more than 60 in. (152.4 cm) away from the washer.
- Never create an airtight seal between the hose and the drain with tape or other means. If no air gap is present, water can be siphoned out of the tub resulting in poor wash/rinse performance or clothing damage.

### CAUTION

- Do not insert the end of the drain hose into the standpipe more than 8 inches (20cm). **Doing so can cause siphoning, odors, or improper draining.**

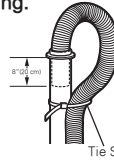

No more than 8 inches (20cm)

Tie Strap

### OPTION 2: LAUNDRY TUB

Bend the end of the drain hose to the desired shape and support it on the edge of the laundry tub. Use the tie strap to secure the drain hose in place.

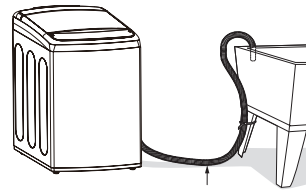

Drain Hose

### NOTE:

- Do not use this drain hose with a floor drain. The end of the drain hose must be at least 29 inches above the floor for proper draining to occur.

## LEVELING THE WASHER

The tub of your new washer spins at very high speeds. To minimize vibration, noise, and movement, the floor must be a level, solid surface.

### NOTE:

- Adjust the leveling feet only as far as necessary to level the washer. Extending the leveling feet more than necessary can cause the washer to vibrate.
- Before installing the washer, make sure that the floor is clean, dry and free of dust, dirt, water and oil so the washer feet cannot slide easily. Leveling feet that move or slide on the floor can contribute to excessive vibration and noise due to poor contact with the floor.

All four leveling feet must rest solidly on the floor. Attempt to rock the washer from corner to corner to make sure that all four leveling feet are in firm contact with the floor.

1. Position the washer in its final location, taking special care not to pinch, strain, or crush the water and drain lines. Place a level across the top of the washer.

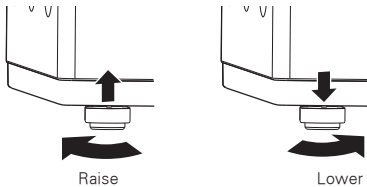

2. Adjust the leveling feet. Turn clockwise to raise the washer or counterclockwise to lower it.

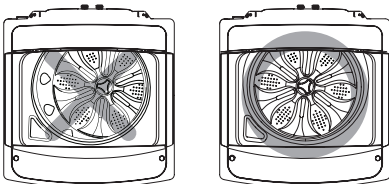

3. To make sure that the washer is properly level, open the lid and look from above to see if the tub is centered. If the tub is NOT centered (as shown in the drawing with the X through it), readjust the front feet. If you have a level, check your washer with the level.

- To check if the washer is level from side to side, place a level on the back edge of the lid.
- To check if the washer is level front to back, place a level at the side of the washer on the edge where

the cabinet side meets the top cover. Do not place the level on the top of the lid. Using these surfaces will result in the washer being unlevel.

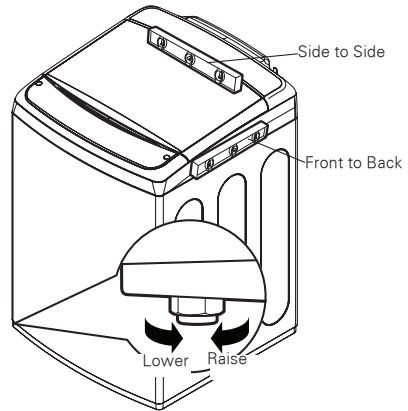

### ⚠ WARNING

- Using the washing machine without leveling it may result in malfunction caused by the production of excess vibration and noise.
- **Use the leveling feet only when you level the washing machine.** If you raise the leveling feet unnecessarily, it may cause abnormal vibration of the washing machine.

### NOTE:

- If the lid will not stay open, the washer may need to be leveled. Extend the front leveling legs until the washer is level.

## CONNECT TO THE POWER SUPPLY SORTING WASH LOADS

The washer should be plugged into a 120-VAC, 60-Hz grounded 3-prong outlet. Plug in the washer. Improper connection of the equipment-grounding conductor can result in risk of electric shock. Check with a qualified electrician or service technician if you are in doubt as to whether the appliance is properly grounded. Do not modify the plug provided with the appliance. If it does not fit the outlet, have a proper outlet installed by a qualified electrician. Failure to follow these warnings can cause serious injury, fire, electrical shock, or death.

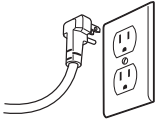

### ⚠️ WARNING

- The power outlet must be within 60 inches (1.5 m) of either side of the washer.
- The appliance and outlet must be positioned so that the plug is easily accessible.
- Do not overload the outlet with more than one appliance.
- The outlet must be grounded in accordance with current wiring codes and regulations.
- Time-delay fuse or circuit breaker is recommended.
- It is the personal responsibility and obligation of the product owner to have a proper outlet installed by a qualified electrician.
- Do not use a worn or damaged power cord or power plug. Replace or repair it immediately. Failure to do so may result in death, fire, electric shock, or malfunction.
- Do not modify the power cord and take care not to damage it when installing or moving the washing machine. Failure to do so may result in death, fire, electric shock, or malfunction.
- Make sure that the washing machine is grounded.
- Connect this washing machine to a grounded outlet conforming to the rating prior to use. Failure to do so may result in fire, electric shock, or malfunction.
- Do not use adaptors or extension cords. The washing machine should always be plugged into its own individual electrical outlet which has a voltage rating that matches the rating plate. Failure to do so may result in fire, electric shock or disorder.
- Do not damage or cut off the ground prong of the power cord. Doing so may cause death, fire, electric shock, or product malfunction.

### ⚠️ CAUTION

- Do not load items higher than the top edge of the tub. Failure to follow this caution can result in leakage or damage to fabrics.
- Use the Bedding cycle for buoyant or nonabsorbent items such as pillows or comforters. Failure to follow this caution can result in leakage.
- If possible, do not wash any water-resistant items. If you must, please select the Waterproof cycle. (i.e. Water resistant clothing, mattress covers, outdoor clothes, plastic mats etc.)
- If waterproof material laundry is washed in a course other than Waterproof, it may result in injury or damage to the washer, clothes, walls, floor, and surrounding objects due to abnormal vibration.

### GROUPING SIMILAR ITEMS

For the best washing results, and to reduce the possibility of damage to clothing, care should be taken to sort the clothing into loads that are made up of similar items.

Mixing different fabric types and/or soil levels can result in poor wash performance, color transfer, discoloration, fabric damage or linting. Fabrics should be sorted into groups as described below.

### COLORS

Sort articles by color. Wash dark clothes together in a separate load from light colors or whites. Mixing dark clothes with light clothes can result in dye transfer or discoloration of the lighter clothes.

### SOIL LEVEL

Wash heavily soiled clothing together. Washing lightly soiled clothing in the same load with heavily soiled clothing could result in poor wash performance for the lightly soiled clothing.

### FABRIC TYPE

Delicate articles should not be mixed with heavier or sturdier fabric types. Washing heavier fabrics in a delicate load can result in poor wash performance for the heavier fabrics and possible damage to the delicacies.

### LINT TYPE

Some fabrics attract and bind lint to them while others give off lint in the laundry process. Avoid mixing these lint collectors and lint producers in the same load. Mixing these fabrics will result in pilling and linting on the lint collectors. (For example, lint collector – knit sweater; lint producer – terry cloth towels.)

### SORT LAUNDRY...



By Colors	By Soil	By Fabric	By Lint
White	Heavy	Delicates	Lint Producer
Lights	Normal	Easy Care	Line Collector
Darks	Light	Sturdy	

### FABRIC CARE LABELS



Many articles of clothing include a fabric care label. Using the chart below, adjust the cycle and option selections to care for your clothing according to the manufacturer’s recommendations.

**Fabric Care Labels**



**Machine wash cycle**

		
Normal	Permanent press/ wrinkle resistant	Gentle/ delicate



**Hand wash**

		
Hand wash	Do not wash	Do not wring

**Water temperature**

		
Hot	Warm	Cold/cool

**Bleach symbols**

		
Any bleach (when needed)	Only non-chlorine bleach (when needed)	Do not bleach

### LOADING THE WASHER



- Check all pockets to make sure that they are empty. Items such as clips, matches, pens, coins, and keys can damage both your washer and your clothes.
- Close zippers, hooks, and drawstrings to prevent these items from snagging or tangling on other clothes.
- Pretreat heavily stained areas for best results.
- Combine large and small items in a load. Load large items first.
- Large items should not be more than half of the total wash load.
- The washer can be fully loaded, but the tub should not be tightly packed with items. The lid of the washer should close easily.
- To prevent an out-of-balance load, do not wash single items. Add one or two similar items to the load. Large, bulky items, such as a blanket, comforter, or bedspread, should be washed individually.
- Waterproof items do wash or spin Waterproof cycle. (i.e. Water resistant clothing, mattress covers, outdoor clothes, plastic mats etc.)
- The washer will not fill or operate with the lid open.

**NOTE:** Use the Bedding cycle for large or bulky items such as poly-filled jackets, comforters, pillows, etc. These items may not be as absorbent as other laundry items and should be sorted into a separate wash load for optimal results.

Bulky items should be placed as far down in the tub as possible for optimal results. Always place buoyant items at the bottom of the tub. The washer will automatically detect the load size. Because of the high-efficiency wash system, the water level may not completely cover the load.

1. For best performance, load clothes as shown.

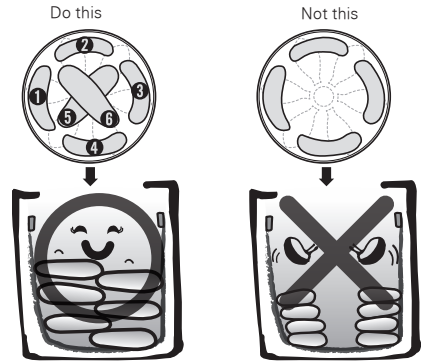

2. Load clothes loosely, and do not load clothes over the maximum guideline on the tub. Clothes need room to circulate in order to get clean.

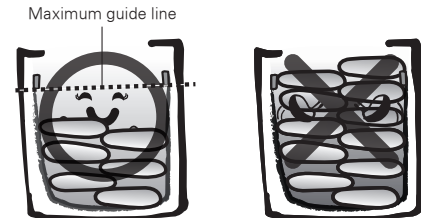

## ABOUT THE DISPENSERS

The automatic dispenser consists of two compartments which hold:

- Liquid fabric softener.
- Liquid or powdered detergent for the main wash.

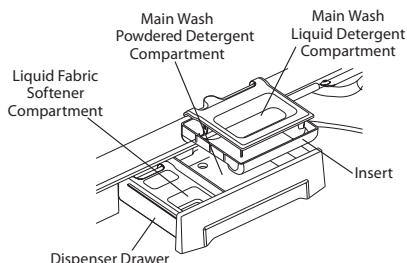

### MAIN WASH DETERGENT COMPARTMENT

This compartment holds laundry detergent for the main wash cycle. The detergent is added to the load at the beginning of the cycle. Always use High-Efficiency (HE) detergent with your washing machine. Either powdered or liquid detergent may be used.

**Never** exceed the manufacturer's recommendations when adding detergent. Using too much detergent can result in detergent buildup in clothing and the washer.

When using liquid detergent, make sure the liquid detergent cup and insert are in place. Do not exceed the maximum fill line.

When using powdered detergent, remove the liquid detergent cup from the compartment. Powdered detergent will not dispense with the liquid detergent cup in place.

### FABRIC SOFTENER COMPARTMENT

This compartment holds liquid fabric softener, which is automatically dispensed during the final rinse cycle.

Never exceed the manufacturer's recommendations when adding softener. Using too much fabric softener can result in damage to clothing and the washer. Either powdered or liquid fabric softener.

- Always follow the manufacturer's recommendations when adding fabric softener. Do not exceed the maximum fill line. Using too much fabric softener may stain clothes.
- Dilute concentrated fabric softeners with warm water. Do not exceed the maximum fill line.
- Never pour fabric softener directly onto the load or into the tub.

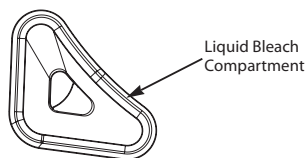

### LIQUID BLEACH COMPARTMENT

The bleach dispenser is a separate compartment at the left front of the tub opening. This compartment holds liquid bleach, which is dispensed automatically at the proper time during the wash cycle. Any liquid remaining in the dispenser at the end of the cycle is water, not bleach.

- Do not add powdered bleach to this compartment. The bleach compartment is designed to dispense liquid bleach only. Powdered or liquid color-safe bleach will not dispense properly.
- Always follow the manufacturer's recommendations when adding bleach. Never add more than one cup and do not exceed the maximum fill line since this can cause the bleach to be dispensed immediately, resulting in damage to fabrics. Using too much bleach can damage fabrics.
- Never pour undiluted liquid chlorine bleach directly onto the load or into the tub. Fabric damage can occur.
- Do not use color-safe bleach or Oxi products in the same cycle with liquid chlorine bleach.

### **⚠ DANGER**

**Do NOT mix chlorine bleach with ammonia or acids, such as vinegar or rust/scale remover.** Mixing chemicals like these can produce a lethal gas, resulting in severe injury or death.

### DETERGENT AND DISPENSER USE A WORD ABOUT DETERGENTS

High-Efficiency (HE) detergents produce fewer suds, dissolve more efficiently to improve washing and rinsing performance, and help to keep the interior of your washer clean. Using detergent that is not HE may cause oversudsing and unsatisfactory performance which could result in error codes, cycle failure, and machine damage.

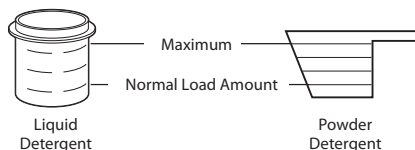



For proper wash performance, always measure the detergent using the measuring device provided by the detergent manufacturer.

The normal amount of HE detergent needed, for average loads, is less than ½ of the recommended maximum. Use less detergent for soft water, light soil or smaller loads. Never use more than the maximum amount recommended by the detergent manufacturer.



### DESIGNED TO USE ONLY HIGH-EFFICIENCY (HE) DETERGENT

**IMPORTANT:** Your washing machine is designed for use with only High-Efficiency (HE) detergents. HE detergents are formulated specifically for High-Efficiency washers and contain suds-reducing agents. Always look for the HE symbol when purchasing detergent.

**IMPORTANT:** Not all detergents are the same. Pay careful attention to the amount of detergent used to avoid oversudsing, poor rinsing and detergent buildup in clothing, and residue buildup that can contribute to odors in the machine. NEVER use a cup or scoop other than the one supplied by the manufacturer of the detergent you are using. Never use more than the maximum amount of detergent recommended by the manufacturer. A full scoop or measure of detergent should only be used for very large and heavily soiled loads. Using too much detergent can result in detergent buildup in the washer and in your clothes.

Always measure the detergent amount. While HE detergents are designed for this type of washing machine, be careful when measuring the detergent. For most normal loads, no more than 1/4 to 1/2 a cap or scoop of HE detergent should be used.

#### NOTE:

- Extra care must be exercised when using 2X and 3X concentrated detergents because even a little bit extra can contribute to the problems mentioned above.
- Detergents designated as HE compatible may not provide optimal results.

### USING THE SOFTENER AND DETERGENT DISPENSER

To add detergent, and fabric softener to the automatic dispenser:

1. Open the dispenser drawer.
2. Load the laundry products into the appropriate compartments.
3. Close the drawer before starting the cycle.

4. If using fabric softener on NORMAL or HEAVY DUTY cycles, press the FABRIC SOFTENER button or select the EXTRA RINSE option.

**NOTE:** It is normal for a small amount of water to remain in the bleach dispenser and softener compartment at the end of the cycle.

**IMPORTANT:** Do not place or store laundry products, such as detergent, bleach, or liquid fabric softener, on top of your washer or dryer. Wipe up any spills immediately. These products can damage the finish and controls.

### USING THE LIQUID BLEACH DISPENSER

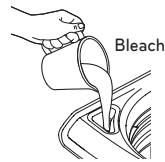

The bleach dispenser automatically dilutes and dispenses liquid bleach at the proper time in the wash cycle.

1. Check clothing care labels for special instructions.
2. Measure liquid bleach carefully, following instructions on the bottle. High-efficiency washers use less water, so less bleach is needed. One half cup is enough for most loads.
3. Carefully pour the pre-measured amount of bleach directly into the bleach dispenser. If you are using powdered bleach of any kind, pour it directly into the tub before adding the laundry. Never add powdered bleach to the liquid bleach dispenser.
  - Never pour undiluted liquid chlorine bleach directly onto clothes or into the tub.
  - Do not pour powdered bleach into bleach dispenser.
  - Do not place laundry items on top of the bleach dispenser when loading and unloading the washer.
  - Always measure and pour bleach carefully. Avoid overfilling or splashing when adding bleach to the dispenser. The maximum capacity of the bleach dispenser is one cup of bleach per wash cycle. Overfilling could result in bleach being dispensed immediately, which can result in damage to the clothes in the washer.