

45-HI
INDOOR



45-H
OUTDOOR

ECCOTEMP
THE FUTURE OF EFFICIENCY



ECCOTEMP 45 SERIES RESIDENTIAL INDOOR/OUTDOOR GAS TANKLESS

WATER HEATER

USE & CARE MANUAL

WITH INSTALLATION INSTRUCTIONS FOR THE INSTALLER

PHONE: 866-356-1992 | EMAIL: SUPPORT@ECCOTEMP.COM | ADDRESS: 315 - A INDUSTRIAL RD SUMMERVILLE, SC 29483

 **SUPPORT:** ECCOTEMP.COM/HELP-DESK  **SHOP ONLINE:** ECCOTEMP.COM/PRODUCT  **STORE LOCATOR:** ECCOTEMP.COM/LOCATOR

ECCOTEMP.COM



Eccotemp Systems, LLC 315-A Industrial Road Summerville, SC 29483 866-356-1992					
AUTOMATIC INSTANTANEOUS WATER HEATER					
MODEL #:	45H-NG	Maximum Input Rating (Btu per hour):	140,000		
SERIAL #		Minimum Input Rating (Btu per hour):	25,000		
TYPE GAS:	NATURAL GAS ONLY	Minimum Inlet Gas Pressure:	4" w.c (1Kpa)		
Voltage:	120 Volts	Maximum Inlet Gas Pressure:	10.5" w.c (2.61Kpa)		
Frequency:	60 Hz	Manifold Pressure:	3.05" w.c (0.76Kpa)		
Amps:	Less than 12 Amperes	Maximum Working Pressure:	150 psi		
Recovery Rating:	As used in this standard, the quantity of water obtained by multiplying the manufacturer's input rating in Btu per hour by the thermal efficiency and dividing the product by 825 Btu per gallon. This is based on a 100°F temperature rise, and a nominal specific heat for water of 8.25 Btu per gallon per degree F.				
Not recommended in excess of 2,000 ft. above sea level.			Category III Water Heater		
CANADIAN HIGH ALTITUDE RATING					
		0-2000 feet	2000-4500 feet		
Input (btu/hr)	140,000		126,000		
Manifold pressure (in. w.c)	3.05		2.24		
ANSI Z21.10.3-2014/CSA 4.3-2014 CAN 2.17 STANDARD		SUITABLE FOR WATER (POTABLE) HEATING ONLY			
FOR YOUR SAFETY Do not store or use gasoline or other flammable vapors and liquids in the vicinity of this or any other appliance		This appliance must be installed in accordance with local codes or, in the absence of local codes, the <i>National Fuel Gas Code, ANSI Z223.1/NFPA 54</i> or the <i>CSA B149.1, Natural Gas and Propane Installation Code</i>			
The unit must be installed on a fire retardant area, and must be away from all combustible materials. Clearance should be 1.75 ft to the left and right side of combustible materials, and 6.75 ft to the front.					
Open on three sides and an overhead clearance of 36"					
The temperature and pressure relief valve provided by the manufacturer shall be installed at the time of installation of the heater in the location specified by the manufacturer. Local codes shall govern installation of relief devices. For safe operation of the water heater, the relief valve must not be removed or plugged.					
OUTDOOR USE ONLY					

Eccotemp Systems, LLC 315-A Industrial Road Summerville, SC 29483 866-356-1992					
AUTOMATIC INSTANTANEOUS WATER HEATER					
MODEL #:	45H-LP	Maximum Input Rating (Btu per hour):	140,000		
SERIAL #		Minimum Input Rating (Btu per hour):	25,000		
TYPE GAS:	LIQUID PROPANE ONLY	Minimum Inlet Gas Pressure:	9" w.c (2.24 Kpa)		
Voltage:	120 Volts	Maximum Inlet Gas Pressure:	13" w.c (3.23Kpa)		
Frequency:	60 Hz	Manifold Pressure:	4.93" w.c (1.22Kpa)		
Amps:	Less than 12 Amperes	Maximum Working Pressure:	150 psi		
Recovery Rating:	As used in this standard, the quantity of water obtained by multiplying the manufacturer's input rating in Btu per hour by the thermal efficiency and dividing the product by 825 Btu per gallon. This is based on a 100°F temperature rise, and a nominal specific heat for water of 8.25 Btu per gallon per degree F.				
Not recommended in excess of 2,000 ft. above sea level.			Category III Water Heater		
CANADIAN HIGH ALTITUDE RATING					
		0-2000 feet	2000-4500 feet		
Input (btu/hr)	140,000		126,000		
Manifold pressure (in. w.c)	4.93		3.62		
ANSI Z21.10.3-2014/CSA 4.3-2014 CAN 2.17 STANDARD		SUITABLE FOR WATER (POTABLE) HEATING ONLY			
FOR YOUR SAFETY Do not store or use gasoline or other flammable vapors and liquids in the vicinity of this or any other appliance		This appliance must be installed in accordance with local codes or, in the absence of local codes, the <i>National Fuel Gas Code, ANSI Z223.1/NFPA 54</i> or the <i>CSA B149.1, Natural Gas and Propane Installation Code</i>			
The unit must be installed on a fire retardant area, and must be away from all combustible materials. Clearance should be 1.75 ft to the left and right side of combustible materials, and 6.75 ft to the front.					
Open on three sides and an overhead clearance of 36"					
The temperature and pressure relief valve provided by the manufacturer shall be installed at the time of installation of the heater in the location specified by the manufacturer. Local codes shall govern installation of relief devices. For safe operation of the water heater, the relief valve must not be removed or plugged.					
OUTDOOR USE ONLY					

Eccotemp Systems, LLC 315-A Industrial Road Summerville, SC 29483 866-356-1992					
AUTOMATIC INSTANTANEOUS WATER HEATER					
MODEL #:	45HI-NG	Maximum Input Rating (Btu per hour):	140,000		
SERIAL #		Minimum Input Rating (Btu per hour):	25,000		
TYPE GAS:	NATURAL GAS ONLY	Minimum Inlet Gas Pressure:	4" w.c (1Kpa)		
Voltage:	120 Volts	Maximum Inlet Gas Pressure:	10.5" w.c (2.61Kpa)		
Frequency:	60 Hz	Manifold Pressure:	3.05" w.c (0.76Kpa)		
Amps:	Less than 12 Amperes	Maximum Working Pressure:	150 psi		
Recovery Rating:	As used in this standard, the quantity of water obtained by multiplying the manufacturer's input rating in Btu per hour by the thermal efficiency and dividing the product by 825 Btu per gallon. This is based on a 100°F temperature rise, and a nominal specific heat for water of 8.25 Btu per gallon per degree F.				
Not recommended in excess of 2,000 ft. above sea level.			Category III Water Heater		
CANADIAN HIGH ALTITUDE RATING					
		0-2000 feet	2000-4500 feet		
Input (btu/hr)	140,000		126,000		
Manifold pressure (in. w.c)	3.05		2.24		
ANSI Z21.10.3-2014/CSA 4.3-2014 CAN 2.17 STANDARD		SUITABLE FOR WATER (POTABLE) HEATING ONLY			
FOR YOUR SAFETY Do not store or use gasoline or other flammable vapors and liquids in the vicinity of this or any other appliance		This appliance must be installed in accordance with local codes or, in the absence of local codes, the <i>National Fuel Gas Code, ANSI Z223.1/NFPA 54</i> or the <i>CSA B149.1, Natural Gas and Propane Installation Code</i>			
The unit must be installed on a fire retardant area, and must be away from all combustible materials. Minimum clearances from combustible construction, 6 inches sides, 0 inches back and 12 inches top.					
The temperature and pressure relief valve provided by the manufacturer shall be installed at the time of installation of the heater in the location specified by the manufacturer. Local codes shall govern installation of relief devices. For safe operation of the water heater, the relief valve must not be removed or plugged.					
This water heater requires a special venting system. Refer to the installation instructions for parts list and method of installation.					

Eccotemp Systems, LLC 315-A Industrial Road Summerville, SC 29483 866-356-1992					
AUTOMATIC INSTANTANEOUS WATER HEATER					
MODEL #:	45HI-LP	Maximum Input Rating (Btu per hour):	140,000		
SERIAL #		Minimum Input Rating (Btu per hour):	25,000		
TYPE GAS:	LIQUID PROPANE ONLY	Minimum Inlet Gas Pressure:	9" w.c (2.24 Kpa)		
Voltage:	120 Volts	Maximum Inlet Gas Pressure:	13" w.c (3.23Kpa)		
Frequency:	60 Hz	Manifold Pressure:	4.93" w.c (1.22Kpa)		
Amps:	Less than 12 Amperes	Maximum Working Pressure:	150 psi		
Recovery Rating:	As used in this standard, the quantity of water obtained by multiplying the manufacturer's input rating in Btu per hour by the thermal efficiency and dividing the product by 825 Btu per gallon. This is based on a 100°F temperature rise, and a nominal specific heat for water of 8.25 Btu per gallon per degree F.				
Not recommended in excess of 2,000 ft. above sea level.			Category III Water Heater		
CANADIAN HIGH ALTITUDE RATING					
		0-2000 feet	2000-4500 feet		
Input (btu/hr)	140,000		126,000		
Manifold pressure (in. w.c)	4.93		3.62		
ANSI Z21.10.3-2014/CSA 4.3-2014 CAN 2.17 STANDARD		SUITABLE FOR WATER (POTABLE) HEATING ONLY			
FOR YOUR SAFETY Do not store or use gasoline or other flammable vapors and liquids in the vicinity of this or any other appliance		This appliance must be installed in accordance with local codes or, in the absence of local codes, the <i>National Fuel Gas Code, ANSI Z223.1/NFPA 54</i> or the <i>CSA B149.1, Natural Gas and Propane Installation Code</i>			
The unit must be installed on a fire retardant area, and must be away from all combustible materials. Minimum clearances from combustible construction, 6 inches sides, 0 inches back and 12 inches top.					
The temperature and pressure relief valve provided by the manufacturer shall be installed at the time of installation of the heater in the location specified by the manufacturer. Local codes shall govern installation of relief devices. For safe operation of the water heater, the relief valve must not be removed or plugged.					
This water heater requires a special venting system. Refer to the installation instructions for parts list and method of installation.					



WARNING: If the information in these instructions is not followed exactly, a fire or explosion may result causing property damage, personal injury or death.

- **Do not store or use gasoline or other flammable vapors and liquids in the vicinity of this or any other appliances.**
- **WHAT TO DO IF YOU SMELL GAS**
 - **Do not try to light any appliances.**
 - **Do not touch any electrical switch; do not use any phone in your building.**
 - **Immediately call your gas supplier from a neighbor's phone. Follow the gas supplier's instructions.**
 - **If you cannot reach your gas supplier, call the fire department.**
- **Installation and service must be performed by a qualified installer, service agency or the gas supplier.**



Use & Care Manual

With Installation Instructions for the Installer

Residential Outdoor Gas

140,000 BTU Max Input @ 6.8 GPM

Tankless Water Heater

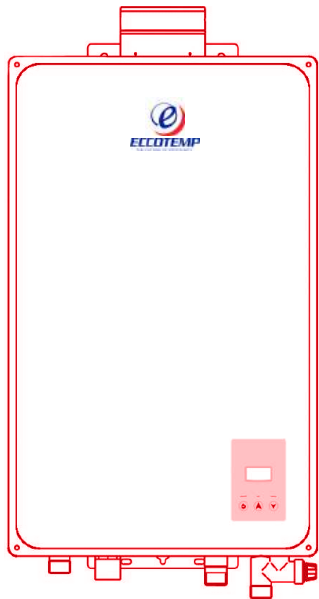
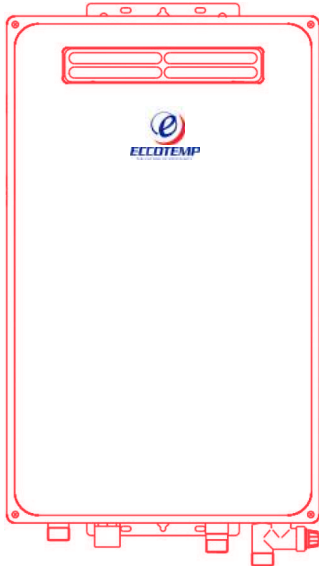

⚠ WARNING: This water heater may not be suitable for use in manufactured (mobile) homes! Please check local code restrictions pertaining to permanent/fixed installations in manufactured homes in your area.

The purpose of this manual is twofold: one, to provide the installer with the basic directions and recommendations for the proper installation and adjustment of the water heater; and two, to the owner-operator, to explain the features, operation, safety precautions, maintenance and troubleshooting of the water heater. This manual also includes a parts list.

It is imperative that all persons who are expected to install, operate or adjust this water heater read the instructions carefully so they may understand how to perform these operations. If you don't understand these instructions or any terms within it, seek professional advice.

Any questions regarding the operation, maintenance, service or warranty of this water heater should be directed to the seller from whom it was purchased. If additional information is required, refer to the section on If You Need Service.

Do not destroy this manual. Please read carefully and keep in a safe place for future reference.

- ⚠** Recognize this symbol as an indication of Important Safety Information!
- ⚠** California Proposition 65 Warning: This product contains chemicals known to the State of California to cause cancer, birth defects or other reproductive harm.
- ⚠ WARNING:** If the information in these instructions is not followed exactly, a fire or explosion may result causing property damage, personal injury or death.

⚠ FOR YOUR SAFETY!

Improper installation, adjustment, alteration, service or maintenance can cause property damage, personal injury, or death. Refer to this manual. Installation and service must be performed by a qualified installer, service agency or the gas supplier.

DO NOT store or use gasoline or other flammable vapors or liquids or other combustible materials in the vicinity of this or any other appliance. To do so may result in an explosion or fire.

WHAT TO DO IF YOU SMELL GAS

- **DO NOT** try to light any appliances.
- **DO NOT** touch any electrical switch; do not use any phone in your building.
- Immediately call your gas supplier from a neighbor's phone. Follow the gas supplier's instructions.
- If you cannot reach your gas supplier, call the fire department.
- **DO NOT** return to your home until authorized by the gas supplier or fire department.

PLEASE NOTE: 45H IS FOR OUTDOOR PERMANENT INSTALLATIONS ONLY AND 45HI IS FOR INDOOR PERMANENT INSTALLATIONS ONLY. THIS MANUAL AND ALL ECCOTEMP CONTACT IS SUBJECT TO CHANGE WITHOUT NOTICE. PLEASE VISIT WWW.ECCOTEMP.COM/SUPPORT FOR MORE INFORMATION.



Safety Information

Safety Precautions 3-6

45-H Installation Instructions

Location7-8
 Typical Installation9
 Water Connections10
 Gas Supply.....10
 Relief Valve.....11
 Leak Testing.....12
 High Altitude12
 Venting12
 Remote Control13-14
 Electrical Connection15
 Pipe Insulation16
 Mounting17
 Installation Checklist18

45-HI Installation Instructions

Location 19-21
 Typical Installation22
 Water Connections23-24
 Gas Supply.....24
 Relief Valve.....25
 Leak Testing.....25
 High Altitude 25
 Venting26-31
 Remote Control32-33
 Electrical Connection34
 Pipe Insulation35
 Mounting36
 Installation Checklist37

Operating Instructions

Start Instructions38-39
 Water Temperature40
 Temperature Memory.....40

Care and Cleaning

Maintenance41
 Housekeeping41-42
 Extended Shut-Down42
 Anti-Freezing.....42
 Draining42-44

Troubleshooting Tips

Before You Call45
 Error Code Guide46

Customer Service

Parts List.....47-48

**FOR YOUR RECORDS**

Write the model and serial numbers here:

You can find them on a label on the water heater and/or packaging.

Staple sales slip or canceled check here.

Proof of the original purchase date is needed to obtain service under the warranty.

**READ THIS MANUAL**

Inside you will find many helpful hints on how to use and maintain your water heater properly. A little preventive care on your part can save you time and money over the life of your water heater. You'll find many answers to common problems in the Troubleshooting Guide. If you review the chart of Troubleshooting Tips first, you may not need to call for service.

**READ THE SAFETY INFORMATION**

Your safety and the safety of others are very important. There are many important safety messages in this manual and on your water heater. Always read and obey all safety messages. This is the safety alert symbol. Recognize this symbol as an indication of Important Safety Information! This symbol alerts you to potential hazards that can kill or hurt you and others.



All safety messages will follow the safety alert symbol and either the word **"DANGER"**, **"WARNING"**, **"CAUTION"** or **"NOTICE"**.

These words mean:

DANGER - An imminently hazardous situation that will result in death or serious injury.

WARNING - A potentially hazardous situation that could result in death or serious injury and/or damage to property.

CAUTION - A potentially hazardous situation that may result in minor or moderate injury.

NOTICE: Attention is called to observe a specified procedure or maintain a specific condition.

PLEASE NOTE: 45H IS FOR OUTDOOR PERMANENT INSTALLATIONS ONLY AND 45HI IS FOR INDOOR PERMANENT INSTALLATIONS ONLY. THIS MANUAL AND ALL ECCOTEMP CONTACT IS SUBJECT TO CHANGE WITHOUT NOTICE. PLEASE VISIT WWW.ECCOTEMP.COM/SUPPORT FOR MORE INFORMATION.



IMPORTANT SAFETY INFORMATION READ ALL INSTRUCTIONS BEFORE USING

Be sure to read and understand the entire Use and Care Manual before attempting to install or operate this water heater. It may save you time and money. Pay particular attention to the Safety Instructions. Failure to follow these warnings could result in serious bodily injury or death. Should you have problems understanding the instructions in this manual, or have any questions, STOP, and get help from a qualified service technician, or the local gas utility.

DANGER! PROPERLY INSTALL WATER HEATER



Failure to properly install the water heater outdoors as outlined in the Installation Instructions in this manual can result in unsafe operation of the water heater. To avoid the risk of fire, explosion, or asphyxiation from carbon monoxide, never operate this water heater unless it is installed properly and has an adequate air supply for proper operation. Be sure to inspect the flue terminal for proper installation at initial start-up; and at least annually thereafter. Refer to the Care and Cleaning section of this manual for more information regarding flue terminal inspection.

WARNING!



Gasoline, as well as other flammable materials and liquids (adhesives, solvents, paint thinners etc.), and the vapors they produce are extremely dangerous. DO NOT handle, use or store gasoline or other flammable or combustible materials anywhere near or in the vicinity of a water heater or any other appliance. Be sure to read and follow the labels on the water heater, as well as the warnings printed in this manual. Failure to do so can result in property damage, bodily injury or death.

DANGER

<p> Vapors from flammable liquids will explode and catch fire causing death or severe burns.</p> <p>Do not use or store flammable products such as gasoline, solvents or adhesives in the same room or area near the water heater.</p> <p>Keep flammable products :</p> <ol style="list-style-type: none"> 1. Far away from heater 2. In approved containers 3. Tightly closed 4. Out of children 's reach 	<p>Water heater has a main burner flame. The main burner flame</p> <ol style="list-style-type: none"> 1. Can come on at any time and 2. Will ignite flammable vapors. <p>Vapors:</p> <ol style="list-style-type: none"> 1. Cannot be seen 2. Are heavier than air 3. Go a long way on the floor 4. Can be carried from other rooms to the main burner flame by air currents.
<p>Installation:</p> <p>Do not install water heater where flammable products will be stored or used unless the main burner flame is at least 18" above the floor. This will reduce, but not eliminate, the risk of vapors being ignited by the main burner flame.</p>	
<p>Read and follow water heater warnings and Instructions. If owners manual is missing, contact the retailer or manufacturer.</p>	

PLEASE NOTE: 45H IS FOR OUTDOOR PERMANENT INSTALLATIONS ONLY AND 45HI IS FOR INDOOR PERMANENT INSTALLATIONS ONLY. THIS MANUAL AND ALL ECCOTEMP CONTACT IS SUBJECT TO CHANGE WITHOUT NOTICE. PLEASE VISIT WWW.ECCOTEMP.COM/SUPPORT FOR MORE INFORMATION.



IMPORTANT SAFETY INFORMATION

READ ALL INSTRUCTIONS BEFORE USING

⚠️ DANGER! WATER TEMPERATURE SETTING



Safety and energy conservation are factors to be considered when selecting the water temperature setting. Water temperatures above 125°F can cause severe burns or death from scalding. The thermostat is adjusted to its lowest temperature position when shipped from the factory. Be sure to read and follow the warnings outlined on the label pictured below.

DANGER



Water temperature over 125°F can cause severe burns instantly or death from scalds. Children, disabled and elderly are at highest risk of being scalded. See instruction manual before setting temperature at water heater. Feel water before bathing or showering. Temperature limiting valves are available, see manual.

Time/Temperature Relationship in Scalds	
Water Temperature	Time To Produce a Serious Burn
120°F	More than 5 minutes
125°F	1 1/2to 2 minutes
130°F	About 30 seconds
135°F	About 10 seconds
140°F	Less than 5 seconds
145°F	Less than 3 seconds
150°F	About 1 1/2 seconds
155°F	About 1 second

Table courtesy of Shriners Burn Institute

The chart shown above may be used as a guide in determining the proper water temperature for your home

⚠️ DANGER: Households with small children, disabled, or elderly persons may require a 120°F. or lower temperature setting to prevent contact with "HOT" water.

Maximum water temperature occurs while burner is on. To find water temperature being delivered, turn on a hot water faucet and place a thermometer in the water stream and read the thermometer.

The temperature of the water at the outlet of the water heater can be regulated by setting the temperature on Remote Control . The remote control was set at 110°F before it was shipped from the factory.

The illustration to the bottom left illustrates the Remote Control and how to adjust the water temperature.

NOTICE: When this water heater is supplying general purpose hot water requirements for use by individuals, a thermostatically controlled mixing valve for reducing point of use water temperature is recommended to reduce the risk of scald injury. Contact a licensed plumber or the local plumbing authority for further information.

NOTICE: The factory recommended operating temperatures are between 90°F and 140°F.

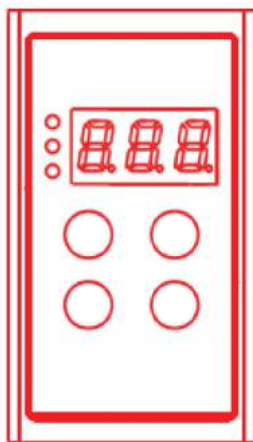

PLEASE NOTE: 45H IS FOR OUTDOOR PERMANENT INSTALLATIONS ONLY AND 45HI IS FOR INDOOR PERMANENT INSTALLATIONS ONLY. THIS MANUAL AND ALL ECCOTEMP CONTACT IS SUBJECT TO CHANGE WITHOUT NOTICE. PLEASE VISIT WWW.ECCOTEMP.COM/SUPPORT FOR MORE INFORMATION.



DANGER! **NATURAL GAS AND LIQUEFIED PETROLEUM MODELS**



Both LP and natural gas have an odorant added to aid in detecting a gas leak. Some people may not physically be able to smell or recognize this odorant. If you are unsure or unfamiliar with the smell of LP or natural gas, ask the gas supplier. Other conditions, such as “odorant fade”, which causes the odorant to diminish in intensity, can also hide or camouflage a gas leak. Always check with commercial leak detector or soapy water.

- Gas detectors are recommended in LP and natural gas applications and their installation should be in accordance with the detector manufacturer’s recommendations and/or local laws, rules, regulations or customs.
- Water heaters utilizing LP gas are different from natural gas models. A natural gas water heater will not function safely on LP gas and vice versa.
- No attempt should ever be made to convert the water heater from natural gas to LP gas. To avoid possible equipment damage, personal injury or fire, do not connect the water heater to a fuel type not in accordance with the unit data plate; propane for propane units and natural gas for natural gas units. These units are not certified for any other fuel type.
- LP water heaters should not be installed below grade (for example, in a basement) if such installation is prohibited by federal, state and/or local laws, rules, regulations or customs.
- Propane or LP gas must be used with great caution. It is heavier than air and will collect first in lower areas making it hard to detect at nose level.
- Before attempting to light the water heater, make sure to look and smell for gas leaks. Use a soapy solution to check all gas fittings and connections. Bubbling at a connection indicates a leak that must be corrected. When smelling to detect a gas leak, be sure to sniff near the floor also.
- It is recommended that more than one method, such as soapy solution, gas detectors, etc., be used to detect leaks in gas applications.

Notice: If a gas leak is present or suspected:

- **DO NOT attempt to find the cause yourself.**
- **DO NOT try to light any appliances.**
- **DO NOT touch any electrical switch.**
- **DO NOT use any phone in your building.**
- **Leave the house immediately and make sure your family and pets leave also.**
- **Leave the doors open for ventilation and contact the gas supplier, a qualified service agency or the fire department.**
- **Stay away from the house (or building) until the service call has been made, the leak is corrected and a qualified agency has determined the area to be safe.**

PLEASE NOTE: 45H IS FOR OUTDOOR PERMANENT INSTALLATIONS ONLY AND 45HI IS FOR INDOOR PERMANENT INSTALLATIONS ONLY. THIS MANUAL AND ALL ECCOTEMP CONTACT IS SUBJECT TO CHANGE WITHOUT NOTICE. PLEASE VISIT WWW.ECCOTEMP.COM/SUPPORT FOR MORE INFORMATION.



IMPORTANT SAFETY INFORMATION READ ALL INSTRUCTIONS BEFORE USING

WARNING!

For your safety, the information in this manual must be followed to minimize the risk of fire or explosion, electric shock, or to prevent property damage, personal injury, or loss of life.



FOR INSTALLATIONS I N THE STATE OF CALIFORNIA

California Law requires that residential water heaters must be braced, anchored or strapped to resist falling or horizontal displacement due to earthquake motions. For residential water heaters up to 52 gallon capacity, a brochure with generic earthquake bracing instructions can be obtained from: Office of the State Architect, 400 P Street, Sacramento, CA 95814 or you may call 916-445-8100 or ask a water heater dealer.

However, applicable local codes shall govern installation. For residential water heaters of a capacity greater than 52 gallons or tankless style, consult the local building jurisdiction code for acceptable bracing procedures.



SAFETY PRECAUTIONS

Have the installer show you the location of the gas shut-off valve and how to shut it off if necessary. Turn off the manual shut-off valve if the water heater has been subjected to overheating, fire, flood, physical damage or if the gas supply fails to shut off.

- Read this manual entirely before installing or operating the water heater.
- Use this water heater only for its intended purpose as described in this Use and Care Manual.
- Be sure your water heater is properly installed in accordance with local codes and the provided installation instructions.
- Part of your water heater unless it is specifically recommended in this manual. All other servicing should be referred to a qualified technician.



READ AND FOLLOW THIS SAFETY INFORMATION CAREFULLY .

SAVE THESE INSTRUCTIONS

This water heater must be installed in accordance with these instructions, local codes, utility company requirements, and/or in the absence of local codes, use the latest edition of the American National Standard/National Fuel Gas Code. A copy can be purchased from either the American Gas Association, 400 North Capitol Street Northwest, Washington, DC 20001 as ANSI standard Z223.1 or National Fire Protection Association, 1 Batterymarch Park, Quincy, MA 02269 as NFPA 54. In Canada, the latest edition of the CSA B149.1 Natural Gas and Propane Installation, and the Canadian Electrical Code, CSA C22.1Part1, in the absence of local codes.

PLEASE NOTE: 45H IS FOR OUTDOOR PERMANENT INSTALLATIONS ONLY AND 45HI IS FOR INDOOR PERMANENT INSTALLATIONS ONLY. THIS MANUAL AND ALL ECCOTEMP CONTACT IS SUBJECT TO CHANGE WITHOUT NOTICE. PLEASE VISIT WWW.ECCOTEMP.COM/SUPPORT FOR MORE INFORMATION.



45-H

English

Installing the 45-H water heater

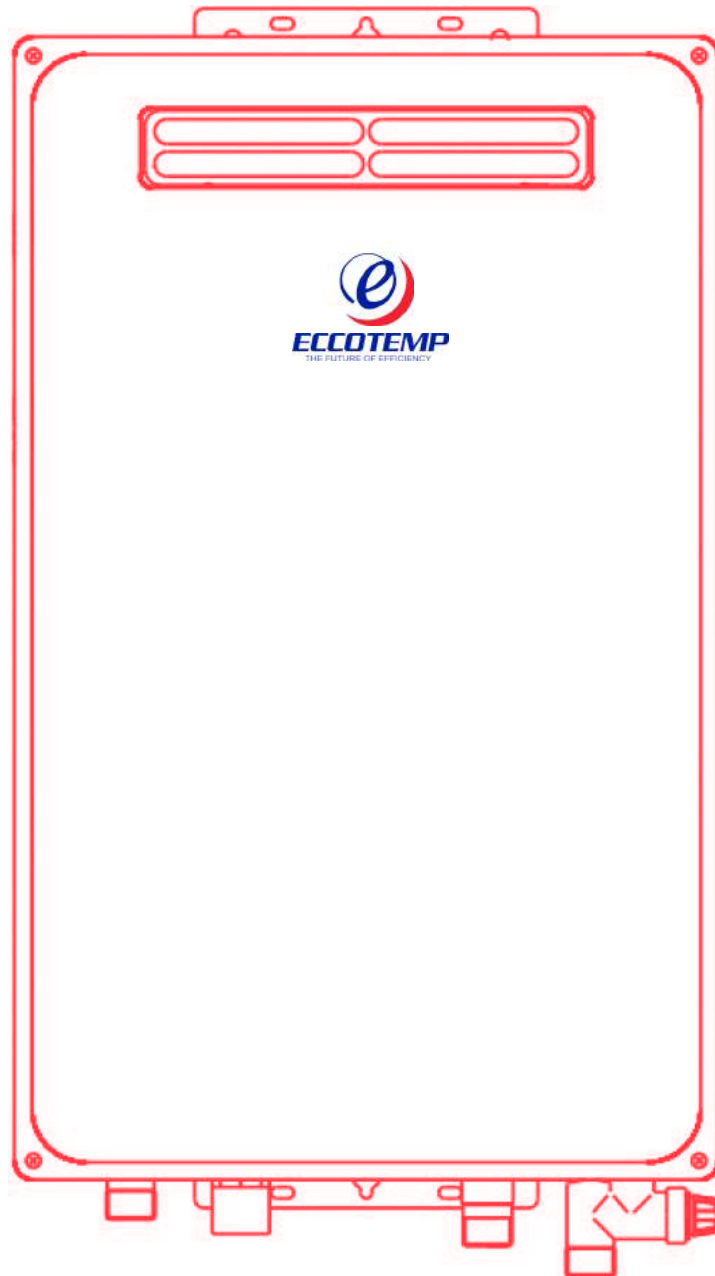

PLEASE NOTE: 45H IS FOR OUTDOOR PERMANENT INSTALLATIONS ONLY AND 45HI IS FOR INDOOR PERMANENT INSTALLATIONS ONLY. THIS MANUAL AND ALL ECCOTEMP CONTACT IS SUBJECT TO CHANGE WITHOUT NOTICE. PLEASE VISIT WWW.ECCOTEMP.COM/SUPPORT FOR MORE INFORMATION.



Installing the 45-H water heater

Location

This water heater is for OUTDOOR installation ONLY!

Make sure before installation that the gas type you will use is the same type on the data plate.

The water heater unit should be installed by professionals from your local gas company. Please don't attempt installation by yourself. Improper installation may cause failure or dangerous conditions such as gas leaking or explosion.

This water heater is an outdoor model and must be mounted on a vertical wall. It must not be installed indoors or in a confined space. The water heater should be installed close to the most frequently used outlet and its position chosen with safety and service in mind.

Make sure people (particularly children, disabled, and elderly) will not touch the hot water outlet or the flue terminal. The flue terminal and air inlet must be clear of obstruction and shrubbery.

If installed in a public corridor, please assure that the surrounding area is free of debris, obstruction and flammable materials.

The unit must be installed on a fire retardant area, and must be away from all flammable materials. Clearance should be 1.75 ft to the left and right side of flammable materials, and 6.75 ft to the front.

The unit should be installed in open area where strong currents are not prevalent

This unit is of high power and will consume a lot of oxygen when working, so the installation area must be well ventilated, and air in and out of the area has no blockage.

The outdoor unit should not be installed in a corridor with rooms on the both sides or in the closed corridor.

Take measures to avoid direct wind, rain and snow. The installation area should be constructed of fire retardant materials. The power socket connecting the water heater should be properly grounded.

The water heater must be located so it is not subject to physical damage, for example, by moving vehicles, area flooding, etc.

The water heater must be installed vertically with the water, gas, and power connections on the underside, pointing toward the ground.

Failure to properly install the water heater outdoors as outlined in this manual can result in unsafe operation.

Hot and cold water lines should be insulated to conserve water and energy.

DO NOT install water heater where subject to vibrations.

DO NOT install the water heater in Recreational Vehicles, Mobile Homes, Boats and other Watercraft.

DO NOT install the water heater near vents for heating or cooling. A minimum of 4 feet should be maintained.

If the clearances stated on the Instruction/Warning Label, located on the front panel of the heater differ, install the water heater according to the clearances stated on the label.

⚠ WARNING: Combustible construction refers to adjacent walls and ceilings and should not be confused with combustible or flammable products and materials. Combustible and/or flammable products and materials should never be stored in the vicinity of this or any gas appliances.

PLEASE NOTE: 45H IS FOR OUTDOOR PERMANENT INSTALLATIONS ONLY AND 45HI IS FOR INDOOR PERMANENT INSTALLATIONS ONLY. THIS MANUAL AND ALL ECCOTEMP CONTACT IS SUBJECT TO CHANGE WITHOUT NOTICE. PLEASE VISIT WWW.ECCOTEMP.COM/SUPPORT FOR MORE INFORMATION.



45-H

Installing the 45-H water heater

Proper operation of the water heater requires air for combustion and ventilation. Provisions for combustion and ventilation air must comply with referenced codes and standards.

Combustion and Ventilation Air

This water heater is for **OUTDOOR** installation **ONLY**.

It must **NOT** be installed indoors or in a confined space.

Corrosive Atmospheres

The air in beauty shops, dry cleaning establishments, photo processing labs, and storage areas for liquid and powdered bleaches or swimming pool chemicals often contain such halogenated hydrocarbons.

NOTICE: The water heater should not be installed near an air supply containing halogenated hydrocarbons.

An air supply containing halogenated hydrocarbons may be safe to breathe, but when it passes through a gas flame corrosive elements are released that will shorten the life of any gas burning appliance.

Propellants from common spray cans or gas leaks from A/ C and refrigeration equipment are highly corrosive after passing through a flame.

The water heater warranty is voided when failure of the heater is due to operation in a corrosive atmosphere.

Inspect Shipment

Inspect the water heater for possible damage. Check the markings on the rating plate of the water heater to be certain the type of gas supplied corresponds to the water heater requirements. Verify all included parts are present (see below).

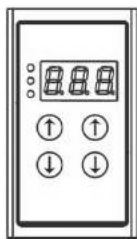

Remote Control



Gas Appliance Shut-Off

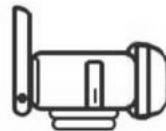

Pressure Relief Valve



Use & Care Manual

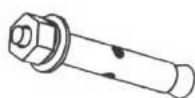

Exposive Screw x 2 pcs.



Wood Screw x 4pcs.



Washer x 2 pcs.

PLEASE NOTE: 45H IS FOR OUTDOOR PERMANENT INSTALLATIONS ONLY AND 45HI IS FOR INDOOR PERMANENT INSTALLATIONS ONLY. THIS MANUAL AND ALL ECCOTEMP CONTACT IS SUBJECT TO CHANGE WITHOUT NOTICE. PLEASE VISIT WWW.ECCOTEMP.COM/SUPPORT FOR MORE INFORMATION.



45-H

English

Installing the 45-H water heater.

Typical Installation (Some Items May Not Apply)

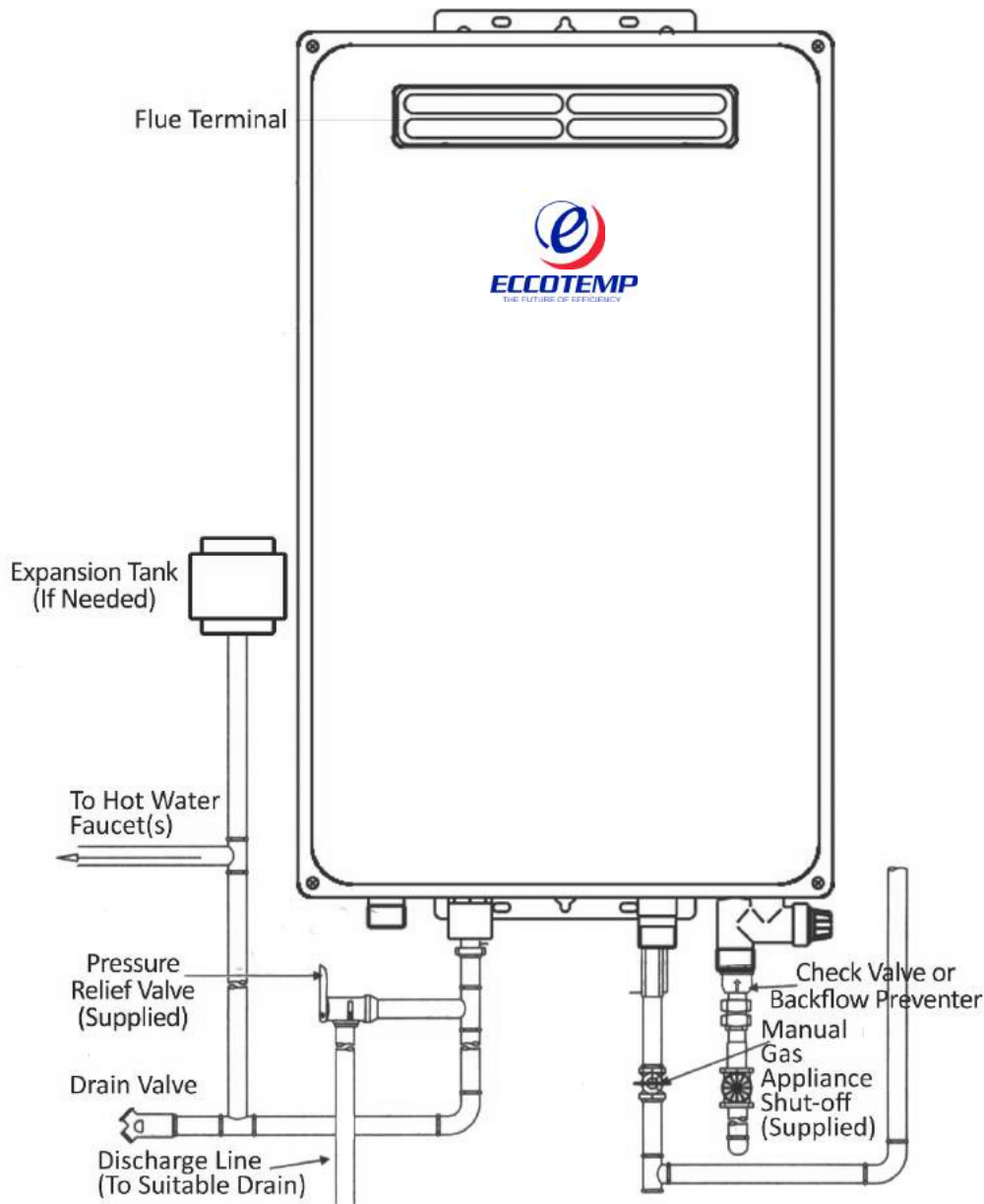

NOTICE: The National Fuel Gas Code (NFPA) mandates a manual gas shut- off valve: See (NFPA) for complete instructions. Local codes or plumbing authority requirements may vary from the instructions or diagrams provided and take precedent over these instructions.

PLEASE NOTE: 45H IS FOR OUTDOOR PERMANENT INSTALLATIONS ONLY AND 45HI IS FOR INDOOR PERMANENT INSTALLATIONS ONLY. THIS MANUAL AND ALL ECCOTEMP CONTACT IS SUBJECT TO CHANGE WITHOUT NOTICE. PLEASE VISIT WWW.ECCOTEMP.COM/SUPPORT FOR MORE INFORMATION.



Water Supply Connections Continued

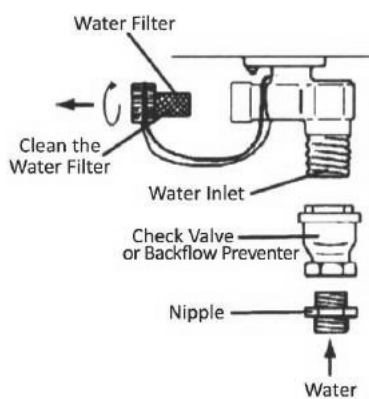

If a water heater is installed in a closed water supply system, such as one having a backflow preventer in the cold water supply line, means shall be provided to control thermal expansion. Contact the water supplier or local plumbing inspector on how to control this situation. Install a shutoff valve near the inlet of the water heater for service and draining purposes.

Before connecting the water supply pipe to the water heater, open the shutoff valve and clean out sand, debris, air, caulking material, etc. inside the pipe. Connect to the water inlet, then check water flow.

Close the shutoff valve and clean the water filter.

Be sure to connect the water inlet and the hot water outlet as shown on the water heater. If reversed, the water heater will not function.

Installation of unions or flexible copper connections are recommended on the HOT and COLD water lines, so that the water heater may disconnect easily for servicing if necessary.

Install a Check Valve between the water heater and the water shutoff valve. (See illustration to the top left).

In regards to the HOT WATER OUTLET:

Connections between the water heater and point(s) of use should be as short and direct as possible.

DO NOT use lead or non-approved plastic pipe.

NOTICE: The flow rate of hot water may vary when more than two faucets (appliances, fixtures, etc.) are being used simultaneously.

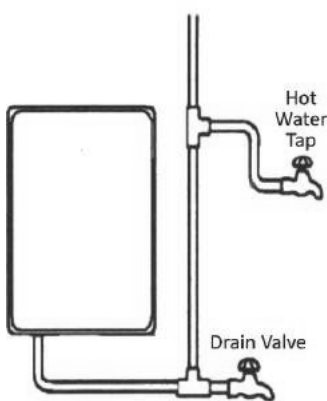

NOTICE: The pipes MUST be completely drainable. If the hot water faucets are located at a point higher than the water heater, place a drain valve at the lowest point (see illustration to the bottom left).

Gas Supply

⚠ WARNING: Do not attempt to convert this water heater for use with a different type of gas other than the type shown on the rating plate. Such conversion could result in hazardous operating conditions. Please have a professional connect the gas pipe.

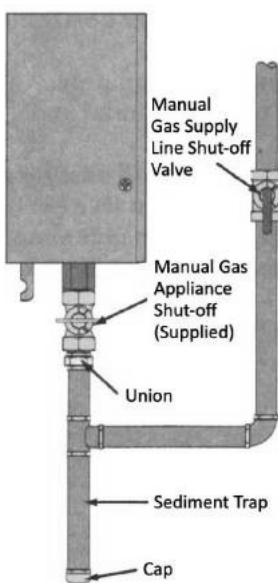

A Manual Gas Appliance Shut-off Valve must be installed at the gas connection of the water heater at the time of installation (see diagram to the left). The branch gas supply line to the water heater should be clean black steel pipe or other approved gas piping material.

A ground joint union or ANSI design certified semi-rigid or flexible gas appliance connector should be installed in the gas line close to the water heater. The National Fuel Gas Code (NFGC) mandates a manual gas shut-off valve: See (NFGC) for complete instructions.

If flexible connectors are used, the maximum length shall not exceed 36".

If lever type gas shut offs are used, they shall be T-Handle type.

Compound used on the threaded joints of the gas piping must be of the type resistant to the action of LP gas. Use compound sparingly on male threads only.

A sediment trap should be installed at the bottom of the gas line.

Do not use excessive force (over 31.5 ft lbs.) in tightening the pipe, particularly if pipe-tape compound is used, as the unit may be damaged.

The inlet gas pressure to the water heater must not exceed 10.5" w.c. for natural or 14" w.c. for LP gas. For purposes of input adjustment, the minimum inlet gas pressure (with main burner on) is shown on the water heater rating plate. If high or low gas pressures are present, contact your gas supplier for correction.

PLEASE NOTE: 45H IS FOR OUTDOOR PERMANENT INSTALLATIONS ONLY AND 45HI IS FOR INDOOR PERMANENT INSTALLATIONS ONLY. THIS MANUAL AND ALL ECCOTEMP CONTACT IS SUBJECT TO CHANGE WITHOUT NOTICE. PLEASE VISIT WWW.ECCOTEMP.COM/SUPPORT FOR MORE INFORMATION.



Relief Valve

A new pressure relief valve, complying with the Standard for relief Valves and Automatic Gas Shut-Off Devices for Hot Water Supply Systems, ANSI Z21.22, must be installed at the hot water outlet connection of the water heater at the time of installation. Local codes shall govern the installation of relief valves. For safe operation of the water heater, be sure that:

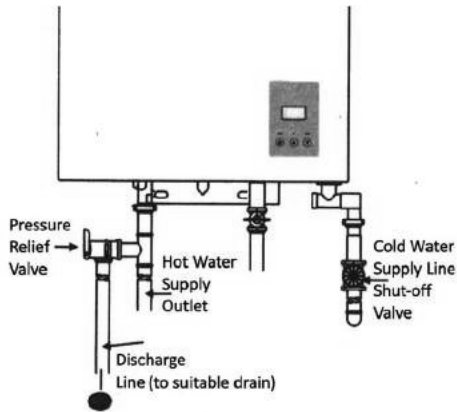

NOTICE: The above illustrates a pressure only relief valve. If local codes require a combination temperature and pressure relief valve be installed, an extension piece may be needed.

- The pressure rating of the relief valve must not exceed 150 psi, the maximum working pressure of the water heater as marked on the rating plate.
- The BTUH rating of the relief valve must equal or exceed the BTUH input of the water heater as marked on its rating plate.
- No valve of any type should be installed between the relief valve and the water heater.
- Discharge from the relief valve should be piped to a suitable drain to eliminate potential water damage. Piping used should be of a type approved for the distribution of hot water.
- Hot and cold water lines should be insulated up to the water heater.
- The discharge line must be NO SMALLER than the outlet of the valve and must pitch downward to allow complete drainage (by gravity) of the relief valve and discharge line.
- The end of the discharge line should not be threaded or concealed and should be protected from freezing. No valve of any type, restriction or reducer coupling should be installed in discharge line.

NOTICE: Local codes govern the installation of relief valves. If local codes require that a temperature and pressure relief valve should be installed the manufacturer recommends a type 40XL Watts T&P relief valve or an equivalent model be used.

NOTICE: Manual operation of relief valves should be performed at least once a year. Turn off the electrical power and gas shutoff valve. Lift and release lever on the relief valve and check the manual operation of the relief valve. You should take precaution to avoid contact with the hot water coming out of the relief valve and to prevent water damage.

NOTICE: If the relief valve on the system discharges periodically, this may be due to thermal expansion in a closed water supply system. Contact the water supplier or local plumbing inspector on how to correct this situation. Do not plug the relief valve.

Pressure Testing the Gas Supply System

⚠ WARNING: Install a gas pressure regulator, in the gas supply line, which does not exceed the maximum supply pressure.

DO NOT use an industrial type gas regulator.

Failure to isolate heater during pressure test can damage internal components voiding warranty. The water heater and its individual shutoff valve must be disconnected from the gas supply piping system during any pressure testing of that system at test pressures in excess of 1/2 psi. The water heater must be isolated from the gas piping system by closing the manual gas shut-off valve during any pressure testing of the gas supply piping at test pressures equal to or less than 1/2 psi (14'w.c.).

PLEASE NOTE: 45H IS FOR OUTDOOR PERMANENT INSTALLATIONS ONLY AND 45HI IS FOR INDOOR PERMANENT INSTALLATIONS ONLY. THIS MANUAL AND ALL ECCOTEMP CONTACT IS SUBJECT TO CHANGE WITHOUT NOTICE. PLEASE VISIT WWW.ECCOTEMP.COM/SUPPORT FOR MORE INFORMATION.



Leak Testing

⚠ WARNING: Never use an open flame to test for gas leaks, as property damage, personal injury, or death could result.

The water heater and its gas connections must be leak tested at normal operating pressures before it is placed in operation.

- Turn on the gas shut-off valve(s) to the water heater.
- Use a commercial leak detector or soapy water solution to test for leaks at all connections and fittings. Bubbles indicate a gas leak that must be corrected.

The factory connections should also be leak tested after the water heater is placed in operation.

High Altitude

Ratings of gas water heaters are based on sea level operation and need not be changed for installations at elevations up to 2,000 feet.

Unit not recommended for elevations in excess of 2,000 feet

Installing the water heater.

Flue Terminal Location

The location of the vent terminal depends on the following minimum clearances and considerations (see illustration):

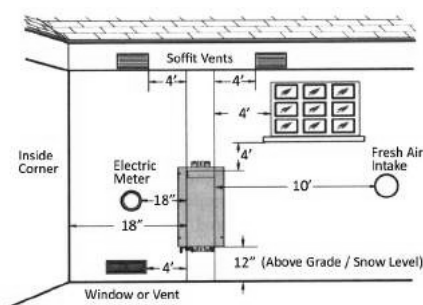

- Twelve (12) inches above grade level and above normal snow levels.
- Four (4) feet below, or four (4) feet horizontally from any door, window, soffit, under eave vent or gravity air inlet to the building or other appliances, or from gas or electric meters. Do not locate vent above walkways, doors, windows, air inlets, gas or electric meters or other equipment.
- Ten (10) feet from any forced air inlet to the building. Any fresh or make-up air inlet such as for a dryer or furnace area is considered to be a forced air inlet.
- Eighteen (18) inches from an inside corner formed by two exterior walls.

Additional Considerations

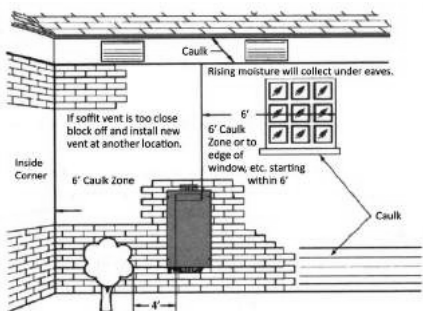

- DO NOT install vent terminal under any patio/deck or too close to shrubbery, as flue gases or condensate vapor may become a nuisance or hazard and may cause property damage. Condensate vapor could cause damage and be detrimental to the operation of regulators, relief valves, or other equipment.
- To help prevent moisture from freezing on walls and under eaves, do not locate vent terminal on the side of a building with prevailing winter winds. The water heater must be located as close as practicable to a chimney or gas vent.
- Caulk all cracks, seams and joints within six (6) feet of vent terminal.
- All painted surfaces should be primed to lessen the chance of physical damage. Painted surfaces will require maintenance.
- Use of cellular core PVC (ASTM F891), cellular core CPVC, or Radel (polyphenylsulfone) in non-metallic venting systems is prohibited. Covering non-metallic vent pipe and fittings with thermal insulation is prohibited.
- DO NOT connect to a chimney flue serving a separate appliance designed to burn solid fuel.

⚠ WARNING : Moisture in the flue gas will condense as it leaves the vent terminal. In cold weather this condensate can freeze on the exterior wall, under the eaves and on surrounding objects. Some discoloration to the exterior of the building is to be expected. However, improper location or installation can result in severe damage to the structure or exterior finish of the building. Code requirements are subject to change and may vary by location.

PLEASE NOTE: 45H IS FOR OUTDOOR PERMANENT INSTALLATIONS ONLY AND 45HI IS FOR INDOOR PERMANENT INSTALLATIONS ONLY. THIS MANUAL AND ALL ECCOTEMP CONTACT IS SUBJECT TO CHANGE WITHOUT NOTICE. PLEASE VISIT WWW.ECCOTEMP.COM/SUPPORT FOR MORE INFORMATION.



⚠ WARNING : Field wiring connections and electrical grounding must comply with local codes, or in the absence of local codes, with the latest edition of the National Electrical Code, ANSI/NFPA 70, or in Canada, Canadian Electrical Code, CSA C22.1 Part 1

Remote Control Installation

The following are considerations for determining the location of the remote control(s):

- **DO NOT** install any remote control outdoors.
- Place remote control(s) out of children's reach.
- The remote control(s) can be installed in convenient locations such as the kitchen, laundry room, or utility room.
- The included remote control can be placed in a convenient location in a bathroom, however, AVOID areas where water may come into contact with the control(s).
- Avoid areas where the remote control(s) may be exposed to heat, e.g. stove ranges or heaters.
- Avoid areas where the remote control(s) may be subjected to oil and/or steam from cooking.
- Avoid areas where chemical agents (such as thinner, benzine and alkaline) are used.
- Avoid areas of direct sunlight.
- The MAXIMUM distance between the water heater and the remote control(s) installation location is limited to 50 feet.
- No other manufacturer's controls are suitable for use with this water heater.
- **DO NOT** attempt to disassemble the remote control.

Remote control - Connection, Installation and Set

(For Panel Control/Remote Control and Remote Control units)

Panel Control/Remote Control and Remote Control units will work with either one or two remote controls. If two remotes are desired, a wire connector will need to be provided. To connect the remote control:

1. For one control: Plug the aviation joint into the socket directly on the water heater (see illustration below)

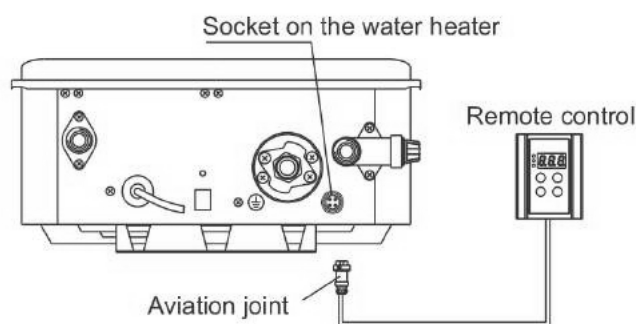

2. For two controls: First, cut off the aviation joints on the two controllers, plug one into the socket on the water heater (length is dependent on your requirements), and throw away the other. Then connect the wires of the aviation joint to the inlet wire of the connector, and connect the two remote control to the outlet wires of connector.

PLEASE NOTE: 45H IS FOR OUTDOOR PERMANENT INSTALLATIONS ONLY AND 45HI IS FOR INDOOR PERMANENT INSTALLATIONS ONLY. THIS MANUAL AND ALL ECCOTEMP CONTACT IS SUBJECT TO CHANGE WITHOUT NOTICE. PLEASE VISIT WWW.ECCOTEMP.COM/SUPPORT FOR MORE INFORMATION.



Installation of Remote Control

1. Remove the front cover of the Remote Control. (See illustration below)

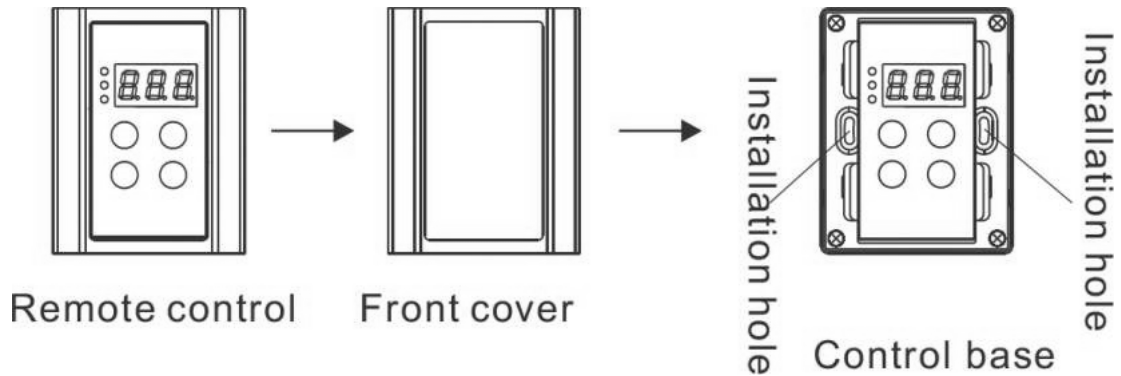

2. At installation site, mark and screw two holes with 0.24" with 1.2" depth. Insert 2 rubber screws into the holes. Place the remote control against the wall, align the holes of control with the holes in the wall, and fasten them with wood thread screws. (See illustration below)

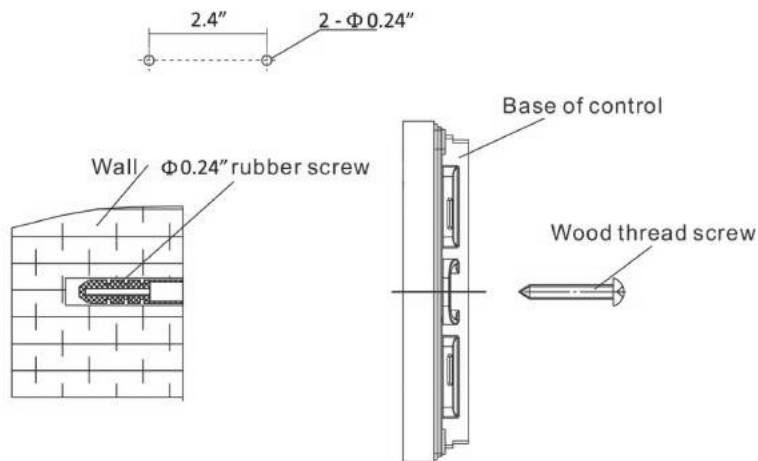

3. Replace the front cover on the remote control.

3. Replace the front cover on the remote control.

PLEASE NOTE: 45H IS FOR OUTDOOR PERMANENT INSTALLATIONS ONLY AND 45HI IS FOR INDOOR PERMANENT INSTALLATIONS ONLY. THIS MANUAL AND ALL ECCOTEMP CONTACT IS SUBJECT TO CHANGE WITHOUT NOTICE. PLEASE VISIT WWW.ECCOTEMP.COM/SUPPORT FOR MORE INFORMATION.



Electrical Connections

⚠ WARNING :Field wiring connections and electrical grounding must comply with local codes, or in the absence of local codes, with the latest edition of the National Electrical Code, ANSI/NFPA 70, or in Canada, Canadian Electrical Code, CSA C22.1 Part 1.

Electrical Connection

POWER CORD:

- The electric power supply requirement for this water heater is 120 VAC/60HZ, 2 Amps.
- The water heater comes with a three (3) pin power supply cord. Use only a power outlet with a ground terminal.
- The installation of an electric leakage breaker is recommended. (GFCI)
- Keep any excess of the power supply cord on the outside of the water heater.
- If local codes require hardwiring, see instructions for "Hardwiring the Electrical Connections".

⚠ WARNING: Shock hazard line voltage is present. Before servicing the water heater, turn off the electrical power to the water heater at the main disconnect or circuit breaker. Failure to do so could result in severe personal injury or death.

HARDWIRING THE ELECTRICAL CONNECTIONS:

- Wiring should be carried out by a qualified electrician in accordance with local codes.
- The water heater requires 120 VAC/60Hz and should be properly grounded.
- DO NOT connect grounding wire to water pipes, gas pipes, telephone cables, lightning conductor circuits and to grounding circuit of other equipment that carry a ground-fault interrupter.
- An ON/OFF switch must be provided and installed for the incoming 120VAC power.
- Wire the water heater exactly as shown below. A wiring diagram is also found inside of the cover panel.
- A green screw is provided in the junction box for grounding connection.
- Connect the live wire to black leg wire and the neutral wire to the white neutral wire.

Electric Wiring Diagram

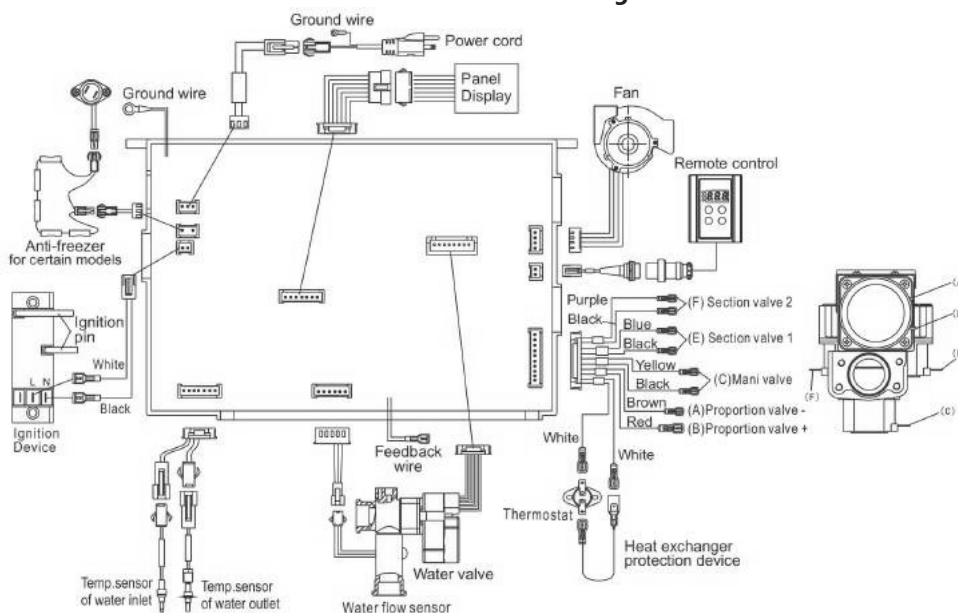

⚠ CAUTION: Label all wires prior to disconnection when servicing controls. Wiring errors can cause improper and dangerous operation. Verify correct operation after servicing.

PLEASE NOTE: 45H IS FOR OUTDOOR PERMANENT INSTALLATIONS ONLY AND 45HI IS FOR INDOOR PERMANENT INSTALLATIONS ONLY. THIS MANUAL AND ALL ECCOTEMP CONTACT IS SUBJECT TO CHANGE WITHOUT NOTICE. PLEASE VISIT WWW.ECCOTEMP.COM/SUPPORT FOR MORE INFORMATION.



Insulation Blankets

⚠ WARNING: If local codes require external application of insulation blanket kits the manufacturer's instructions included with the kit must be carefully followed.

Insulation blankets, available to the general public, for external use on gas water heaters are not necessary. The purpose of an insulation blanket is to reduce the standby heat loss encountered with storage tank heaters. This water heater does not store water making an insulation blanket unnecessary.

The manufacturer's warranty does not cover any damage or defect caused by installation, attachment or use of any type of energy saving

or other unapproved devices (other than those authorized by the manufacturer) into, onto or in conjunction with the water heater.

The use of unauthorized energy saving devices may shorten the life of the water heater and may endanger life and property.

The manufacturer disclaims any responsibility for such loss or injury resulting from the use of such unauthorized devices.

Pipe Installation

Inlet Pipe and Outlet Pipe Installation

Use pressure resistant pipe to connect the inlet and outlet water pipes of the water heater and the local water pipe (Make sure to place the rubber ring). Before connecting the inlet water pipe, flush the inside of the pipe.

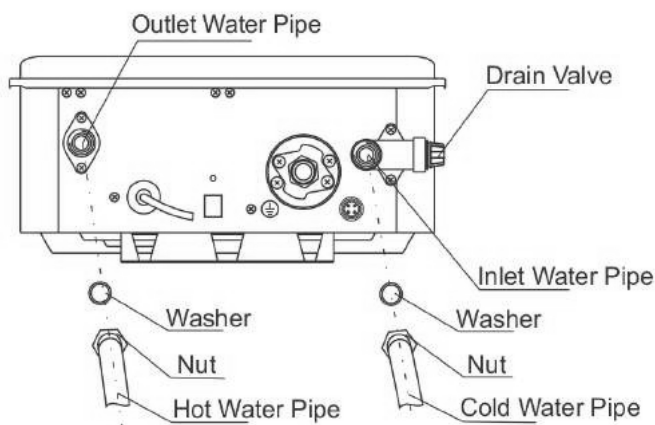

Hot and Cold Pipe

Insulation Installation

For increased energy efficiency, use pipe insulation. Please install the insulation, according to the illustrations above, making sure to insulate all the way to the top. Do not cover any drain or pressure valve(s).

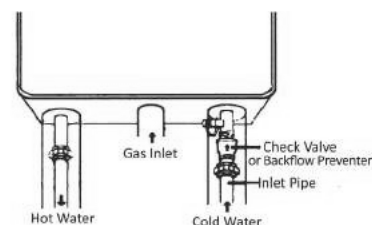

NOTICE: The hot and cold pipes should be insulated as shown help to provide additional freeze protection

During Installation of this water heater...

Do's

- **DO** check inlet gas pressure to ensure that it is within the range specified on the rating plate.
- **DO** provide adequate air for combustion and ventilation as discussed in the Use & Care Manual and the National Gas Code (CAN/CGA B 149 in Canada).
- **DO** maintain proper clearances to combustibles as specified by applicable code.
- **DO** ensure that the flue terminal location complies with the guidelines found in the Use & Care Manual and National Fuel Gas Code (CAN/CGA B 149 in Canada).

Dont's

- **DON'T** block or restrict Air Intake Opening located on the back side of the water heater.
- **DON'T** remove the front cover unless absolutely necessary. This should only be done after being examined by a qualified service technician.
- **DON'T** install this product where standing water may occur.

PLEASE NOTE: 45H IS FOR OUTDOOR PERMANENT INSTALLATIONS ONLY AND 45HI IS FOR INDOOR PERMANENT INSTALLATIONS ONLY. THIS MANUAL AND ALL ECCOTEMP CONTACT IS SUBJECT TO CHANGE WITHOUT NOTICE. PLEASE VISIT WWW.ECCOTEMP.COM/SUPPORT FOR MORE INFORMATION.



Mounting the 45-H Water Heater

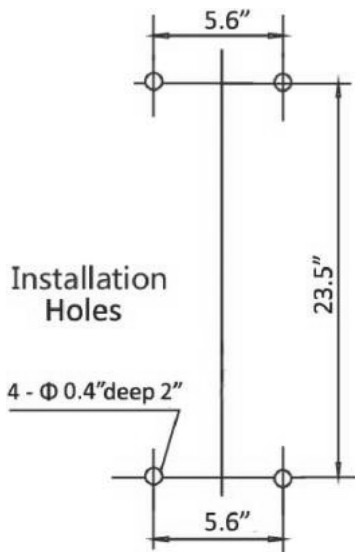

Make sure the location of the water heater allows for easy access and operation. The water heater should be located in an area where leakage of the tank or connections will not result in damage to the area adjacent to the water heater or to lower floors of the structure. When such locations cannot be avoided, it is recommended that a suitable drain pan, adequately drained, be installed under the appliance. The pan must not restrict combustion air flow.

In case of dry wall or concrete wall use dry wall anchors or lag bolts.

The water heater requires 120VAC/ 60Hz. Have a receptacle with ground terminal near the water heater. The length of the power supply cord is 5 feet.

Drill the holes as per the sizes in the figure to the left, put 2 expansion screws into the top holes, and 2 rubber screws into the bottom holes.

Hang up the water heater unit, tighten the expansion screws, and put 2 wood thread screws into the bottom holes.

When being installed directly on carpeting, the water heater shall be installed on a metal or wood panel extending beyond the full width and depth of the water heater by at least 3 in (76.2 mm) in any direction or, if the water heater is installed in an alcove or closet, the entire floor shall be covered by the panel. The panel must be strong enough to carry the weight of the heater when full of water.

⚠ CAUTION: Reinforcement of the wall is required in case the wall is not strong enough to hold the water heater.

Water Supply Connections

Plumbing should be carried out by a qualified plumber in accordance with local codes.

Use approved plumbing materials and tools only.

To conserve energy and to prevent freezing, insulate both cold and hot water supply lines. **DO NOT** cover the drain valves.

To ensure proper operation of the water heater, the following water pressure guidelines should be followed:

- Operation of the water heater requires the minimum water pressure of 14 psi and a minimum water flow rate of 0.75 gpm.
- Additional water pressure is required for long pipe runs and outlet fitting(s) water pressure drops.
- To maintain proper performance, ensure sufficient water supply pressure. The Required Water Pressure = Min. Operating Water Pressure (14 psi) + Pipe Pressure Loss + Faucet and Shower Pressure Loss + Safety Margin (more than 5 psi).

- To supply hot water to upper floors, additional water pressure (0.44 psi/ft) must be ensured. The measurement should be calculated by the distance between the water inlet of the water heater (ground level) to the hot water faucet (upper floor level).
- Well water systems should be set at a range of 50-60 psi.
- When the water is supplied from a water supply tank, the height of the tank and the diameter of the pipes and their relation to water pressure, should be taken into consideration. Gravity **water pressure is not recommended.**

NOTICE: If the water flow resistance of a shower head is too high, the burner in the water heater will fail to ignite. Keep the shower head clean from debris that could cause additional pressure drop.

NOTICE: If using mixing valves on the outlet, choose one which prevents cold water pressure from overcoming hot water line pressure.

IMPORTANT: Do not apply heat to the HOT or COLD water connections. Any heat applied to the water supply fittings will permanently damage the internal components of the water heater.

⚠ CAUTION: This water heater must only be used with the following water supply system conditions:

- **With clean, potable water free of corrosive chemicals, sand, dirt, or other contaminants.**
- **With inlet water temperatures above 32°F, but not exceeding 120°F.**
- **Free of lime and scale deposits.**
- **DO NOT reverse the hot and cold water connections. The water heater will not operate.**

PLEASE NOTE: 45H IS FOR OUTDOOR PERMANENT INSTALLATIONS ONLY AND 45HI IS FOR INDOOR PERMANENT INSTALLATIONS ONLY. THIS MANUAL AND ALL ECCOTEMP CONTACT IS SUBJECT TO CHANGE WITHOUT NOTICE. PLEASE VISIT WWW.ECCOTEMP.COM/SUPPORT FOR MORE INFORMATION.



Installing the 45-H water heater

Installation Check List

A. Water Heater Location

- Installed OUTDOORS.
- Close to area of mostly used outlet.
- Protected from freezing temperatures.
- Proper clearance from combustible surfaces observed.
- Sufficient fresh air supply for proper operation of water heater.
- Air supply free of corrosive elements and flammable vapors.
- Provisions made to protect area from water damage.
- Sufficient room to service heater.
- Combustible materials, such as clothing, cleaning materials, rags, etc. clear of the heater and vent piping.
- Water heater is properly attached to the wall.

B. Water Supply

- Water supply has sufficient pressure.
- Air purged from water heater and piping.
- Water connections tight and free of leaks
- Water filter is clean and in place.
- Materials used are as instructed in this manual.
- Water pipes are insulated.

C. Gas Supply

- Gas type matches rating plate.
- Gas supply pressure is sufficient for the water heater.
- Gas line equipped with shut-off valve, union and sediment trap.
- Approved pipe joint compound used.
- Commercial leak detector or soap and water solution used to check all connections and fittings for possible gas leak.
- Gas Company inspected installation (if required).

D. Relief Valve

- Pressure Relief Valve properly installed and discharge line run to open drain
- Discharge line protected from freezing.

E . Electrical Wiring

- Voltage matches rating plate.
- Water heater is properly grounded .
- Wiring meets all local codes.
- GFCI Protection where required.

PLEASE NOTE: 45H IS FOR OUTDOOR PERMANENT INSTALLATIONS ONLY AND 45HI IS FOR INDOOR PERMANENT INSTALLATIONS ONLY. THIS MANUAL AND ALL ECCOTEMP CONTACT IS SUBJECT TO CHANGE WITHOUT NOTICE. PLEASE VISIT WWW.ECCOTEMP.COM/SUPPORT FOR MORE INFORMATION.



45-HI

English

Installing the 45-HI water heater

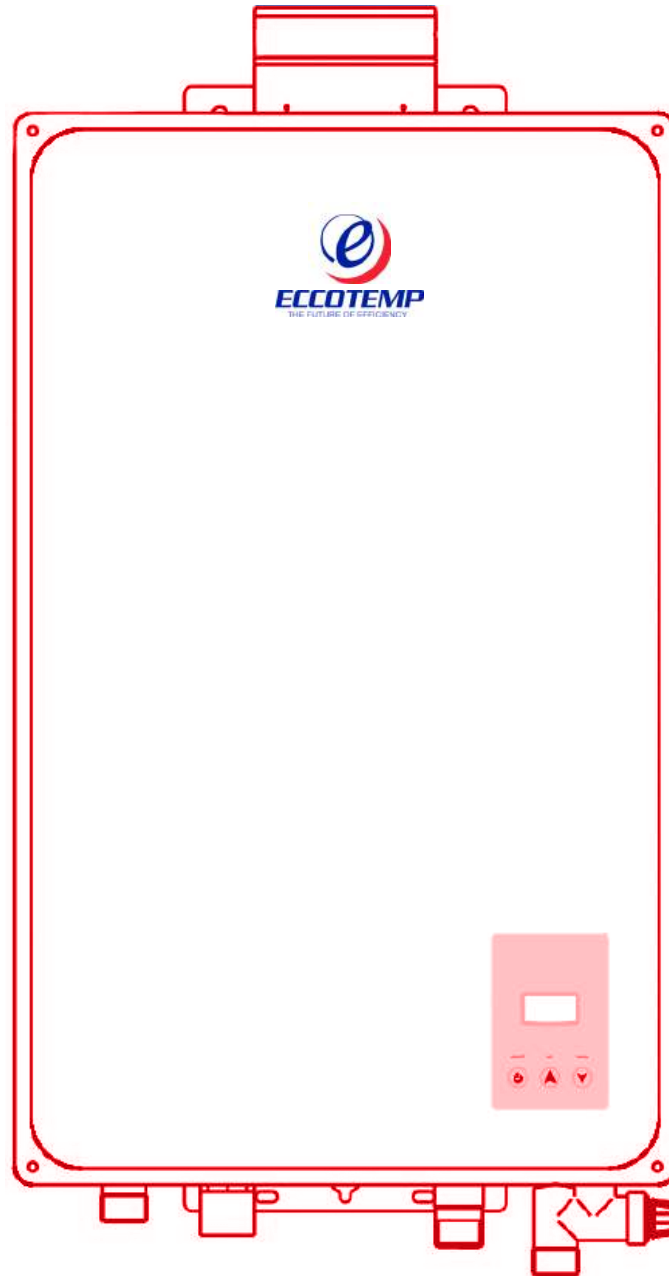

PLEASE NOTE: 45H IS FOR OUTDOOR PERMANENT INSTALLATIONS ONLY AND 45HI IS FOR INDOOR PERMANENT INSTALLATIONS ONLY. THIS MANUAL AND ALL ECCOTEMP CONTACT IS SUBJECT TO CHANGE WITHOUT NOTICE. PLEASE VISIT WWW.ECCOTEMP.COM/SUPPORT FOR MORE INFORMATION.



45-HI

Installing the 45-HI water heater

Indoor Location

- Installation distances may vary by local code. It is the installer's responsibility to verify installation requirements.
- Make sure before installation that the gas type you will use is the same type on the data plate.
- The water heater unit should be installed by professionals. Improper installation may cause failure or dangerous conditions such as gas leaking or explosion.
- Water Heater cannot be installed in an UN-VENTED bathroom, bedroom, basement, living room, closet, outdoor, stairway or an exit area. If installed in an exit area, it must be at least 16.5 ft. or more away from the exit.
- Vent pipe should extend from the wall at least 2". The terminal must be at least 1.64 ft. away from obstruction, and must be well vented.
- Vent pipe should slope 3° downward, to avoid condensing water and protect from rain entering.
- Vent pipe should avoid direct, strong wind because the downdraft will cause malfunction.
- The water heater should be installed far from any blockage, and with plenty of enough space for installation and maintenance. Adequate clearances for servicing must be provided.
- The water heater should not be installed in the same room with a gas stove .
- When determining the floor clearance, a clearance of 6 inches must be maintained between the vent pipe and combustible material. A side wall clearance of 6 inches and a top clearance of 12 inches must be maintained.
- The vent pipe can be up to 32 ft. in length with one elbow.
- The vent pipe should be installed with a flame retardant wall thimble. Owner must refer to vent manufacturer's instructions and specifications. Z-Flex information can be found at www.novaflex.com, please refer to page 19 for additional links. Installation guidelines for venting provided by NovaFlex, who is solely responsible for venting installation accuracy.
- The power socket connecting the water heater should be grounded properly with a GFCI circuit protector.
- The water heater should not be located in an area where leakage of the heat exchanger or connections will result in damage to the area adjacent to it or to lower floors of the structure. When such areas cannot be avoided it is recommended that a suitable catch pan, adequately drained, must be installed under the water heater. The pan must not restrict combustion airflow.
- The water heater should be installed as close as practical to the vent termination to minimize vent length and the number of elbows required for venting.
- A gas fired water heater or any other appliance should not be installed in a space where liquids which give off flammable vapors are to be used or stored. Such liquids include gasoline, LP gas (butane or propane), paint or adhesives and their thinners, solvents or removers.
- The water heater should be installed far from heat sources, flammable and dangerous materials. Because of natural air movement in a room or other enclosed space, flammable vapors can be carried some distance from where their liquids are being used or stored. The open flame of the water heater's main burner can ignite these vapors causing an explosion or fire which may result in severe burns, death or property damage.

PLEASE NOTE: 45H IS FOR OUTDOOR PERMANENT INSTALLATIONS ONLY AND 45HI IS FOR INDOOR PERMANENT INSTALLATIONS ONLY. THIS MANUAL AND ALL ECCOTEMP CONTACT IS SUBJECT TO CHANGE WITHOUT NOTICE. PLEASE VISIT WWW.ECCOTEMP.COM/SUPPORT FOR MORE INFORMATION.



Installing the 45-HI water heater continued....

- Raising the water heater will reduce, **BUT NOT** eliminate the possibility of lighting the vapor of any flammable liquids which may be improperly stored or accidentally spilled .
- If the water heater is installed in a garage, it should be installed so that the direct ignition system and main burner are no less than 18 inches above the garage floor.
- Hot and cold water lines should be insulated to conserve water and energy.
- The water heater must be located so it is not subject to physical damage, for example, by moving vehicles, area flooding, etc.
- The water heater should be installed with the proper venting materials and termination suitable for Category III venting. Failure to install and properly vent the water heater to the outdoors as outlined in the Venting Section of this manual can result in unsafe operation. Owner must refer to vent manufacturer's instructions and specifications. Z-Flex information can be found at www.novaflex.com, please refer to page 19 for additional links.
- For other than a direct vent appliance, the appliance must be located as close as practicable to a chimney or gas vent.
- **DO NOT** install water heater where subject to vibrations. or on the road use
- **DO NOT** install the water heater in Recreational Vehicles, Mobile Homes, Boats and other Watercraft.
- **DO NOT** install the water heater near vents for heating or cooling. A minimum of 4 feet should be maintained.
- If the clearances stated on the Instruction/Warning Label, located on the front panel of the heater differ, install the water heater according to the clearances stated on the label.

⚠ WARNING: Combustible construction refers to adjacent walls and ceilings and should not be confused with combustible or flammable products and materials. Combustible and/or flammable products and materials should never be stored in the vicinity of this or any gas appliance.

PLEASE NOTE: 45H IS FOR OUTDOOR PERMANENT INSTALLATIONS ONLY AND 45HI IS FOR INDOOR PERMANENT INSTALLATIONS ONLY. THIS MANUAL AND ALL ECCOTEMP CONTACT IS SUBJECT TO CHANGE WITHOUT NOTICE. PLEASE VISIT WWW.ECCOTEMP.COM/SUPPORT FOR MORE INFORMATION.



45-HI

Installing the 45-HI water heater continued....

Proper operation of the water heater requires air for combustion and ventilation. Provisions for combustion and ventilation air must comply with referenced codes and standards.

Combustion and Ventilation Air

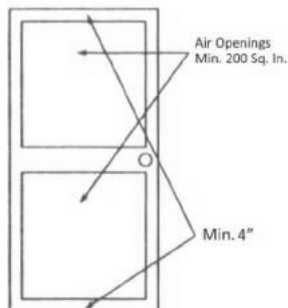

A confined space is one having a volume of less than 50 cubic feet per 1,000 BTUH of the aggregate input of all appliances within that space.

The air must be supplied through two permanent openings of equal area. One is to be located within 12" above the floor and the other is to be located within 12" below the ceiling.

The minimum net free area of each opening must not be less than one square inch per 1,000 BTUH of the total input rating of all the appliances in the enclosure (but not less than 100 square inches), if each opening communicates with other unconfined areas inside the building.

Buildings of unusually tight construction shall have the combustion and ventilation air supplied from outdoors, or a freely ventilated attic or crawl space. If air is supplied from outdoors, directly or through vertical ducts, there must be two openings located as specified above and each must have a minimum net free

area of not less than one square inch per 4,000 BTUH of the total input rating of all the appliances in the enclosure.

If horizontal ducts are used to communicate with the outdoors, each opening must have a minimum net free area of not less than one square inch per 2,000 BTUH of the total input rating of all the appliances in the enclosure. If ducts are used, the minimum dimensions of rectangular air ducts shall not be less than 4"

NOTICE: If the water heater is installed in an unconfined space within a building of conventional frame, masonry or metal construction, infiltration air is normally adequate for proper combustion and ventilation. If the water heater is installed in a confined space, provisions for combustion and ventilation air must be made.

NOTICE: If the duct openings which supply combustion and ventilation air are to be covered with a protective screen or grill, the net free area (openings in the material) of the covering material must be used in determining the size of the openings. Protective screening of the openings MUST NOT be smaller than 1/4" mesh to prevent clogging by lint or other debris. .

Corrosive Atmospheres

The air in beauty shops, dry cleaning establishments, photo processing labs, and storage areas for liquid and powdered bleaches or swimming pool chemicals often contain such halogenated hydrocarbons.

An air supply containing halogenated hydrocarbons may be safe to breathe, but when it passes through a gas flame corrosive elements are released that will shorten the life of any gas burning appliance.

Propellants from common spray cans or gas leaks from A/C and refrigeration equipment are highly corrosive after passing through a flame.

The water heater warranty is voided when failure of the heater is due to operation in a corrosive atmosphere.

NOTICE: The water heater should not be installed near an any air supply containing halogenated hydrocarbons.

Inspect Shipment

Inspect the water heater for possible damage. Check the markings on the rating plate of the water heater to be certain the type of gas supplied corresponds to the water heater requirements. Verify all included parts are present (see below).



Pressure Relief Valve



Gas Appliance Shut-off



Wood Screw x 4 pcs.



Washer x 2 pcs.



Exposive Screw x 2 pcs.



PLEASE NOTE: 45H IS FOR OUTDOOR PERMANENT INSTALLATIONS ONLY AND 45HI IS FOR INDOOR PERMANENT INSTALLATIONS ONLY. THIS MANUAL AND ALL ECCOTEMP CONTACT IS SUBJECT TO CHANGE WITHOUT NOTICE. PLEASE VISIT WWW.ECCOTEMP.COM/SUPPORT FOR MORE INFORMATION.



45-HI

English

Installing the 45-HI water heater.

Typical Installation (Some Items May Not Apply)

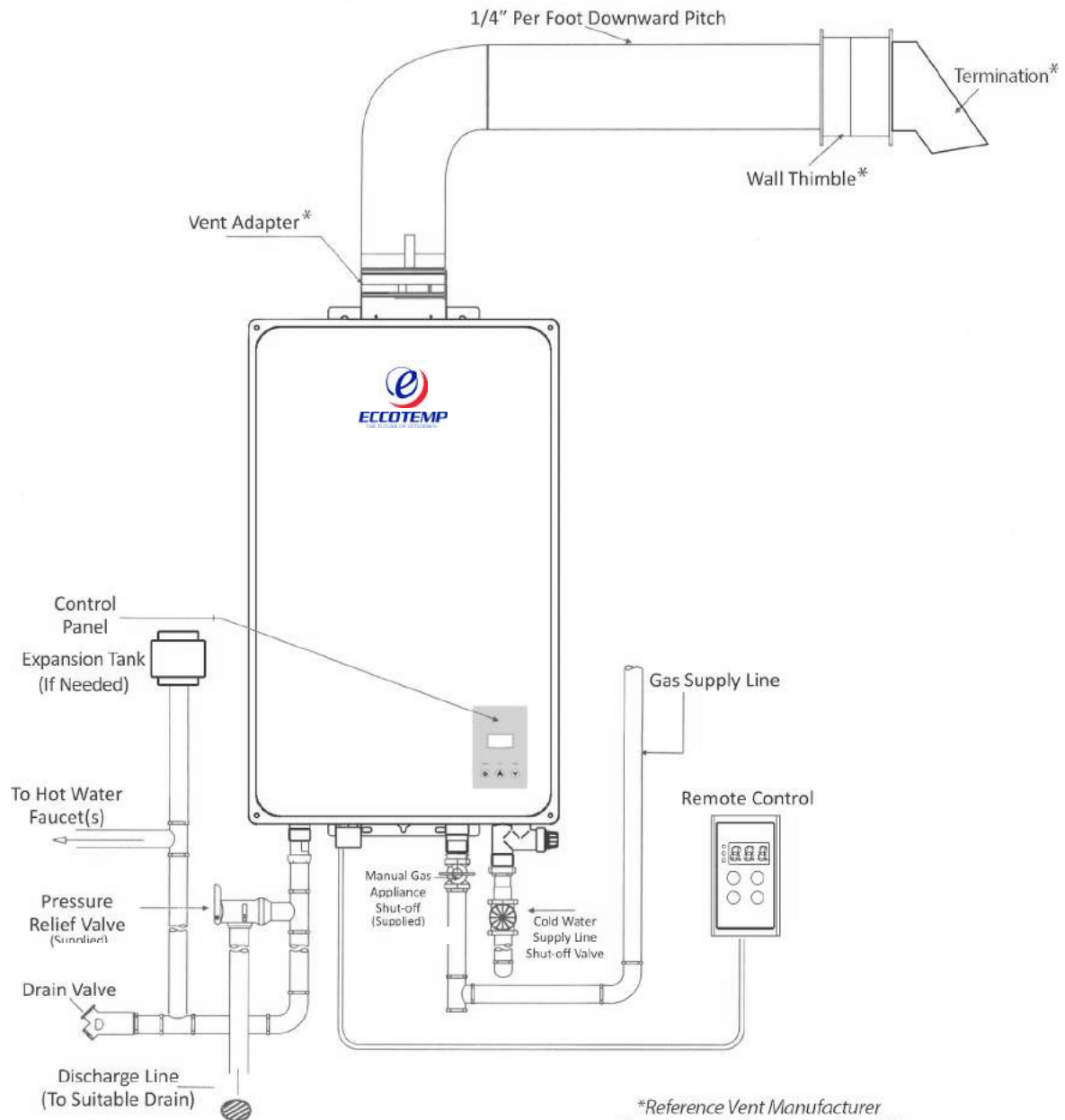

NOTICE: The National Fuel Gas Code (NFGC) mandates a manual gas shut- off valve: See (NFGC) for complete instructions. Local codes or plumbing authority requirements may vary from the instructions or diagrams provided and take precedent over these instructions.

PLEASE NOTE: 45H IS FOR OUTDOOR PERMANENT INSTALLATIONS ONLY AND 45HI IS FOR INDOOR PERMANENT INSTALLATIONS ONLY. THIS MANUAL AND ALL ECCOTEMP CONTACT IS SUBJECT TO CHANGE WITHOUT NOTICE. PLEASE VISIT WWW.ECCOTEMP.COM/SUPPORT FOR MORE INFORMATION.



Water Supply Connections...

Plumbing should be carried out by a qualified plumber in accordance with local codes. Use approved plumbing materials and tools only.

Install a Check Valve between the water heater and the water shutoff valve. (See illustration below).

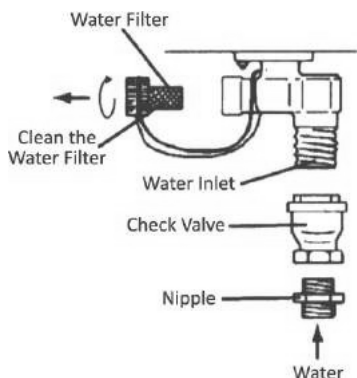

To conserve energy and to prevent freezing, insulate both cold and hot water supply lines. **DO NOT** cover the drain valves. Install a shutoff valve near the inlet of the water heater for service and draining purposes. Before connecting the water supply pipe to the water heater, open the shutoff valve and clean out sand, debris, air, caulking material, etc. inside the pipe. Connect to the water inlet, then check water flow. Close the shutoff valve and clean the water filter.

If a water heater is installed in a closed water supply system, such as one having a backflow preventer in the cold water supply line, means shall be provided to control thermal expansion. Contact the water supplier or local plumbing inspector on how to control this situation.

- ⚠ CAUTION: This water heater must only be used with the following water supply system conditions:**
- **With clean, potable water free of corrosive chemicals, sand, dirt, or other contaminants.**
 - **With inlet water temperatures above 32°F, but not to exceed 90°F.**
 - **Free of lime and scale deposits.**
 - **DO NOT reverse the hot and cold water connections. The water heater will not operate.**

To ensure proper operation of the water heater, the following water pressure guidelines should be followed:

- Operation of the water heater requires the minimum water pressure of 14 psi and a minimum water flow rate of 0.75 gpm.
- Additional water pressure is required for long pipe runs and outlet fitting(s) water pressure drops.
- To maintain proper performance, ensure sufficient water supply pressure. The Required Water Pressure = Min. Operating Water Pressure (14 psi) + Pipe Pressure Loss + Faucet and Shower Pressure Loss + Safety Margin (more than 5 psi).
- To supply hot water to upper floors, additional water pressure (0.44 psi/ft) must be ensured. The measurement should be calculated by the distance between the water inlet of the water heater (ground level) to the hot water faucet (upper floor level).
- Well water systems should be set at a range of 50-60 psi.
- When the water is supplied from a water supply tank, the height of the tank and the diameter of the pipes and their relation to water pressure, should be taken into consideration. Gravity water pressure is not recommended.

IMPORTANT: Do not apply heat to the HOT or COLD water connections. Any heat applied to the water supply fittings will permanently damage the internal components of the water heater.

NOTICE: If the water flow resistance of a shower head is too high, the burner in the water heater will fail to ignite. Keep the shower head clean from debris that could cause additional pressure drop.

Notice: If using mixing valves on the outlet, choose one which prevents cold water pressure from overcoming hot water line pressure.

DO NOT use pipes with smaller diameters than the water supply connection of the water heater.

Be sure to connect the water inlet and the hot water outlet as shown on the water heater. If reversed, the water heater will not function.

Installation of unions or flexible copper connections are recommended on the HOT and COLD water lines, so that the water heater may disconnect easily for servicing if necessary.



Water Supply Connections Continued...

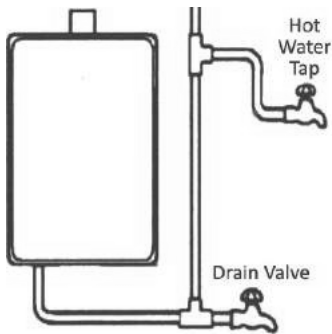

In regards to the HOT WATER OUTLET:

- Connections between the water heater and point(s) of use should be as short and direct as possible.
- DO NOT use lead or non-approved plastic pipe.
- To conserve energy and minimize heat loss, insulation of hot water piping is recommended.

NOTICE: The flow rate of hot water may vary when more than two faucets (appliances, fixtures, etc.) are being used simultaneously.

NOTICE: The pipes MUST be completely drainable. If the hot water faucets are located at a point higher than the water heater, place a drain valve at the lowest point (see diagram to the left).

Gas Supply

⚠ WARNING: Do not attempt to convert this water heater for use with a different type of gas other than the type shown on the rating plate. Such conversion could result in hazardous operating conditions. Please have a professional connect the gas pipe.

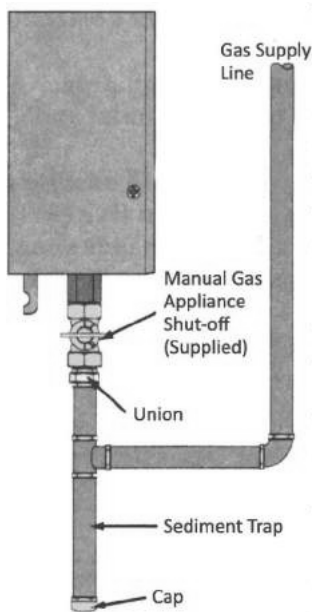

The supplied Manual Gas Appliance Shutoff Valve must be installed at the gas connection of the water heater at the time of installation (see diagram to the left).

The branch gas supply line to the water heater should be clean black steel pipe or other approved gas piping material. A ground joint union or ANSI design certified semi-rigid or flexible gas appliance connector should be installed in the gas line close to the water heater.

The National Fuel Gas Code (NFGC) mandates a manual gas shut-off valve: See (NFGC) for complete instructions.

A sediment trap should be installed at the bottom of the gas line.

The inlet gas pressure to the water heater must not exceed 10.5" w.c. for natural or 14" w.c. for LP gas. For purposes of input adjustment, the minimum inlet gas pressure (with main burner on) is shown on the water heater rating plate. If high or low gas pressures are present, contact your gas supplier for correction.

The water heater and its individual shutoff valve must be disconnected from the gas supply piping system during any pressure testing of that system at test pressures in excess of 1/2 psi (3.5 kPa). The water heater must be isolated from the gas supply piping system by closing its individual manual shutoff valve during any pressure testing of the gas supply piping system at test pressures equal to or less than 1/2 psi (3.5 kPa).

DO NOT use excessive force (over 31.5 ft lbs.) in tightening the pipe, particularly if pipe compound is used, as the unit may be damaged.

Compound used on the threaded joints of the gas piping must be of the type resistant to the action of LP gas. Use compound sparingly and use on male threads only.



Relief Valve

A new pressure relief valve, complying with the Standard for relief Valves and Automatic Gas Shut-Off Devices for Hot Water Supply Systems, ANSI Z21.22, must be installed at the hot water outlet connection of the water heater at the time of installation. Local codes shall govern the installation of relief valves.

For safe operation of the water heater, be sure that:

- The pressure rating of the relief valve must not exceed 150 psi, the maximum working pressure of the water heater as marked on the rating plate.
- The BTUH rating of the relief valve must equal or exceed the BTUH input of the water heater as marked on its rating plate.
- No valve of any type should be installed between the relief valve and the water heater.
- Discharge from the relief valve should be piped to a suitable drain to eliminate potential water damage. Piping used should be of a type approved for the distribution of hot water.
- Hot and cold water lines should be insulated up to the water heater.
- The discharge line must be NO SMALLER than the outlet of the valve and must pitch downward to allow complete drainage (by gravity) of the relief valve and discharge line.
- The end of the discharge line should not be threaded or concealed and should be protected from freezing. No valve of any type, restriction or reducer coupling should be installed in discharge line.

NOTICE: The diagram below illustrates a pressure only relief valve. If local codes require a combination temperature and pressure relief valve be installed, an extension piece may be needed.

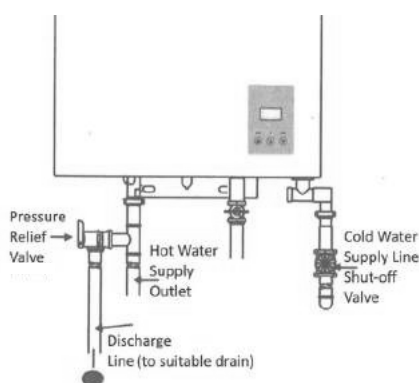

NOTICE: Local codes govern the installation of relief valves. If local codes require that a temperature and pressure relief valve should be installed the manufacturer recommends a type 40XL Watts T&P relief valve or an equivalent model be used.

NOTICE: Manual operation of relief valves should be performed at least once a year. Turn off the electrical power and gas shutoff valve. Lift and release lever on the relief valve and check the manual operation of the relief valve. You should take precaution to avoid contact with the hot water coming out of the relief valve and to prevent water damage.

NOTICE: If the relief valve on the system discharges periodically, this may be due to thermal expansion in a closed water supply system. Contact the water supplier or local plumbing inspector on how to correct this situation. Do not plug the relief valve.

Leak Testing

⚠ WARNING: Never use an open flame to test for gas leaks, as property damage, personal injury, or death could result.

The water heater and its gas connections must be leak tested at normal operating pressures before it is placed in operation.

- Turn on the gas shut-off valve(s) to the water heater.
- Use a commercial leak detector or soapy water solution to test for leaks at all connections and fittings. Bubbles indicate a gas leak that must be corrected.

All connections should also be leak tested after the water heater is placed in operation.

Pressure Testing the Gas Supply System

⚠ WARNING: Install a gas pressure regulator, in the gas supply line, which does not exceed the maximum supply pressure. **DO NOT** use an industrial type gas regulator.

The water heater must be isolated from the gas piping system by closing the manual gas shut-off valve during any pressure testing of the gas supply piping at pressures equal to or less than 1/2 psi (14'w.c.) .

High Altitude

Ratings of gas appliances are based on sea level operation and need not be changed for installations at elevations up to 2,000 feet. Unit not recommended for elevations in excess of 2,000 feet

PLEASE NOTE: 45H IS FOR OUTDOOR PERMANENT INSTALLATIONS ONLY AND 45HI IS FOR INDOOR PERMANENT INSTALLATIONS ONLY. THIS MANUAL AND ALL ECCOTEMP CONTACT IS SUBJECT TO CHANGE WITHOUT NOTICE. PLEASE VISIT WWW.ECCOTEMP.COM/SUPPORT FOR MORE INFORMATION.



Installing the 45-HI water heater

⚠ DANGER: Failure to install the vent adapter and properly vent the water heater to the outdoors as outlined in the Venting section of this manual will result in unsafe operation of the water heater causing death, serious injury, explosion, or fire. To avoid the risk of fire, explosion, or asphyxiation from carbon monoxide, NEVER operate the water heater unless it is properly vented and has adequate air supply for proper operation as outlined in the Venting section of this manual.

⚠ WARNING: Use UL approved Category III Stainless Steel vent material only. No other vent material is permitted. Owner must refer to vent manufacturer's instructions and specifications. Z-Flex information can be found at www.novaflex.com, see page 19 for additional links.

⚠ WARNING: Refer to pages 17-18 for clearances to combustible material.

Venting Through Closed Spaces

If the vent piping passes through a closed space, wrap the vent pipe with inflammable insulation material that is at least 3/4" thick. DO NOT let the insulation material make contact with flammable materials. A minimum clearance of 6" between the vent pipe and ceiling should be maintained. Follow local codes.

For maintenance and inspection purposes, the

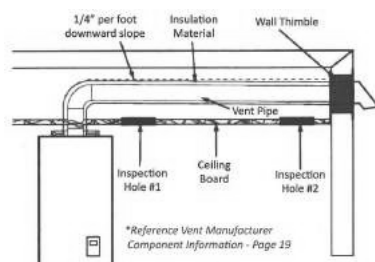

inflammable material when installed in alcoves, closets, and garages and must not touch any flammable material.

Venting

The installation of venting must comply with national codes, local codes, and the vent manufacturer's instructions. Owner must refer to vent manufacturer's instructions and specifications. Z-Flex information can be found at www.novaflex.com, please refer to page 19 for additional links.

The water heater must be vented to the outdoors as described in these instructions. DO NOT connect this water heater to an existing Vent or Chimney, it must be vented separately from all other appliances.

All vent components (adapters, pipe, elbows, terminals, etc.) should be UL 1738 Certified Stainless Steel Venting Material (e.g. AL29-4C).

The specified vent termination must be used. The termination should be a 90° elbow type with screen. (Refer to page 19).

Use a vent pipe with an antidisconnection structure.

The use of a High Temperature Silicone (500' F) may be required to seal vent connections. To prevent accidental gas exhaust leakage, apply a 1/4" wide bead approximately 1/4" from the end and another bead against the joint side of the stop bead.

Follow vent manufacturer's installation instructions.

The unit can be vented either horizontally or vertically.

Vent pipe runs must be adequately supported along both horizontal and vertical runs.

The maximum recommended unsupported span should be no more than five (5) feet. Support isolation hanging bands should be used. **DO NOT** use wire. (See diagram below).

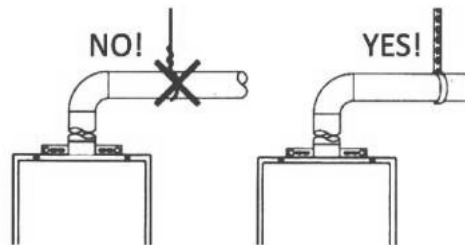

following holes are required to be made:

- Two (2) inspection openings that allow access to venting. One (1) of these openings should be close to where the vent pipe enters the ceiling. The other opening should be near the vent termination.
- A ventilation hole with a 16 sq. in. opening should be made at least every 10 feet.

NOTICE: Vent pipes must be completely insulated with

PLEASE NOTE: 45H IS FOR OUTDOOR PERMANENT INSTALLATIONS ONLY AND 45HI IS FOR INDOOR PERMANENT INSTALLATIONS ONLY. THIS MANUAL AND ALL ECCOTEMP CONTACT IS SUBJECT TO CHANGE WITHOUT NOTICE. PLEASE VISIT WWW.ECCOTEMP.COM/SUPPORT FOR MORE INFORMATION.



Installing the 45-HI water heater, Continued...

Venting Lengths

MAXIMUM VENT LENGTH

Owner must refer to vent manufacturer's instructions and specifications. Z-Flex information can be found at www.novaflex.com, please refer to page 19 for additional links.

Number of 90° elbows (bends)	Maximum Length of Straight Pipe
1	32'
2	27'
3	22'

One (1) 90° Elbow is Equivalent to 5 Feet of Straight Pipe

The system will not operate if there is excessive restriction (pressure drop) in the venting system. A maximum of 32 feet of vent pipe may be used provided there is only one 90° elbow in the system. If additional elbows are required: two elbows can be used with 27 feet, and three elbows can be used with 22 feet of vent pipe.

A 90° elbow is equivalent to 5 feet of straight pipe. A 45° elbow is equivalent to 2 feet 6 inches of straight pipe .

The termination elbow does not count as an elbow when determining total vent lengths.

The vent must be installed with a slight downward slope of 1/4" per foot of horizontal run toward the vent terminal (see diagram below). This ensures that any condensate formed during operation of the unit is evacuated from the water heater.

A 1/4" per foot upward slope is acceptable when it is not possible to vent with a downward slope, however, a UL approved Category III Stainless Steel condensate trap MUST be installed at the beginning of the horizontal run (See page 20 "Typical Horizontal Termination w/ 1/4" per foot UPWARD Slope" or page 14, "Standard Vertical Vent Termination" for examples).

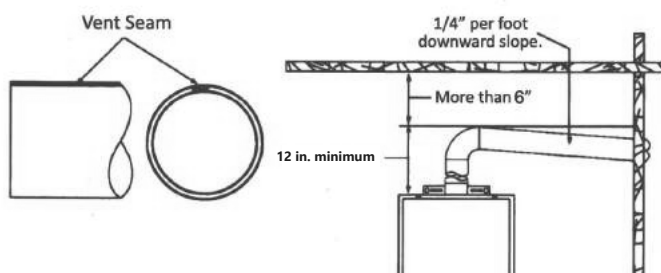

MINIMUM VENT LENGTH

The venting may be as short as 12", provided one vent termination is installed to the outdoors through a sidewall, one 90°elbow is included in the installation, and the wall thimble is installed.

NOTICE: Make sure that the seam of the vent pipe in horizontal runs is toward the top of the installation (see illustration to the left)

Draining the Condensate

In certain conditions, installations in unconditioned space or having long horizontal or vertical runs may accumulate condensate.

Condensate is known to be acidic; refer to local, state (provincial) or federal codes for proper handling methods.

In order to prevent condensate from draining back into the water heater, we recommend a condensate trap and drain to be installed in a horizontal vent section as close as practical to the water heater vent connection.

Not following proper condensate procedures will void warranty.

PLEASE NOTE: 45H IS FOR OUTDOOR PERMANENT INSTALLATIONS ONLY AND 45HI IS FOR INDOOR PERMANENT INSTALLATIONS ONLY. THIS MANUAL AND ALL ECCOTEMP CONTACT IS SUBJECT TO CHANGE WITHOUT NOTICE. PLEASE VISIT WWW.ECCOTEMP.COM/SUPPORT FOR MORE INFORMATION.



Installing the 45-HI water heater, Continued...

VENT TERMINATION CLEARANCES FOR NON-DIRECT VENT INSTALLATIONS IN THE US AND CANADA

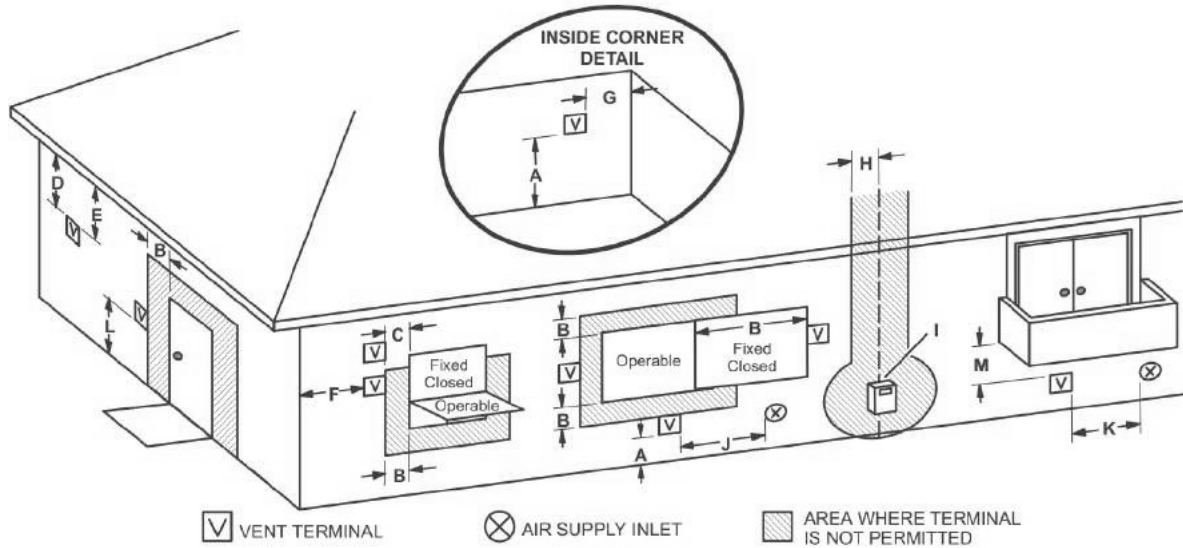

		US Installations ¹	Canadian Installations ²
A =	Clearance above grade, veranda, porch, deck, or balcony	12 in (30 cm)	12 in (30 cm)
B =	Clearance to window or door that may be opened	4 ft (1.2 m) below or to side of opening; 1 ft (300 mm) above opening	6 in (15 cm) for appliances ≤ 10,000 BTUH (3 kW), 12 in (30 cm) for appliances > 10,000 BTUH (3 kW) and ≤ 100,000 BTUH (30 kW), 36 in (91 cm) for appliance > 100,000 BTUH (30 kW)
C =	Clearance to permanently closed window	*	
D =	Vertical clearance to ventilated soffit located above the terminal within a horizontal distance of 2 feet (61 cm) from the center line of the terminal	*	
E =	Clearance to unventilated soffit	*	

PLEASE NOTE: 45H IS FOR OUTDOOR PERMANENT INSTALLATIONS ONLY AND 45HI IS FOR INDOOR PERMANENT INSTALLATIONS ONLY. THIS MANUAL AND ALL ECCOTEMP CONTACT IS SUBJECT TO CHANGE WITHOUT NOTICE. PLEASE VISIT WWW.ECCOTEMP.COM/SUPPORT FOR MORE INFORMATION.



45-HI

F =	Clearance to outside corner	*	
G =	Clearance to inside corner	*	
H =	Clearance to each side of center line extended above meter /regulator assembly	*	3 ft (91 cm) within a height 15 ft above the meter/regulator assembly
I =	Clearance to service regulator vent outlet	*	3 ft (91 cm)
J =	Clearance to nonmechanical air supply inlet to building or the combustion air inlet to any other appliance	4 ft (1.2 m) below or to side of opening; 1 ft (300 mm) above opening	6 in (15 cm) for appliances ≤ 10,000 BTUH (3 kW), 12 in (30 cm) for appliances > 10,000 BTUH (3kW) and ≤ 100,000 BTUH (30 kW), 36 in (91 cm) for appliances > 100,000 BTUH (30 kW)
K =	Clearance to a mechanical air supply inlet	3 ft (91 cm) above if within 10 ft (3 m) horizontally	6 feet (1.83 m)
L =	Clearance above paved sidewalk or paved driveway located on public property	*	7 ft (2.13 m)
M =	Clearance under veranda, porch, deck or balcony	*	12 in (30)

* For clearances not specified in ANSI Z223.1 / NFPA 54 or CSA-B149.1, one of the following shall be indicated:

A) *A minimum clearance value determined by testing in accordance with Clause 5.20, or;*

B) *A reference to the following footnote:*

"Clearance in accordance with local installation codes and the requirements of the gas supplier."

- A vent shall not terminate directly above a sidewalk or paved driveway that is located between two single family dwellings and serves both dwellings.

- Permitted only if veranda, porch, deck, or balcony is fully open on a minimum of two sides beneath the floor.

Notes:

- 1) In accordance with the current CSA B149.1 Natural Gas and Propane Installation Code**
- 2) In accordance with the current ANSI Z223.1 / NFPA 54 National Fuel Gas Cod**

PLEASE NOTE: 45H IS FOR OUTDOOR PERMANENT INSTALLATIONS ONLY AND 45HI IS FOR INDOOR PERMANENT INSTALLATIONS ONLY. THIS MANUAL AND ALL ECCOTEMP CONTACT IS SUBJECT TO CHANGE WITHOUT NOTICE. PLEASE VISIT WWW.ECCOTEMP.COM/SUPPORT FOR MORE INFORMATION.



Ventilation Parts

Owner must refer to vent manufacturer's instructions and specifications by visiting www.novaflex.com. Installation guidelines for venting is provided by NovaFlex, who is solely responsible for venting installation accuracy.

Z-Flex parts are available for purchase by visiting www.eccotemp.com.

Z-Flex Installation Instructions:

www.novaflex.com/information_centre/zflex/032-Vent%20Residential/Z-Vent%20Installation%2Guide%20CURRENT.pdf

Z-Flex Ventilation Parts:

<https://www.eccotemp.com/installation>

Part #	Description	Part #	Description
2ZVB04	Universal Adapter	2ZVWB04	Horizontal Vent Kit
2SVSRPKE04	Vertical Vent Kit	2SVSWTF04	Horizontal Wall Thimble
2SVEEWCF	90 Elbow	2SVSWTEF04	Horizontal Wide Wall Thimble
2SVSTEX0490	90 Termination Elbow	2SVEVWC04	Vertical Drain Tee
2SVSTB04	Termination Box	2SVEDWCF04	Horizontal Drain Pipe
2SVSHTX04	Termination Hood	2SVEPWCF	Vent Pipe

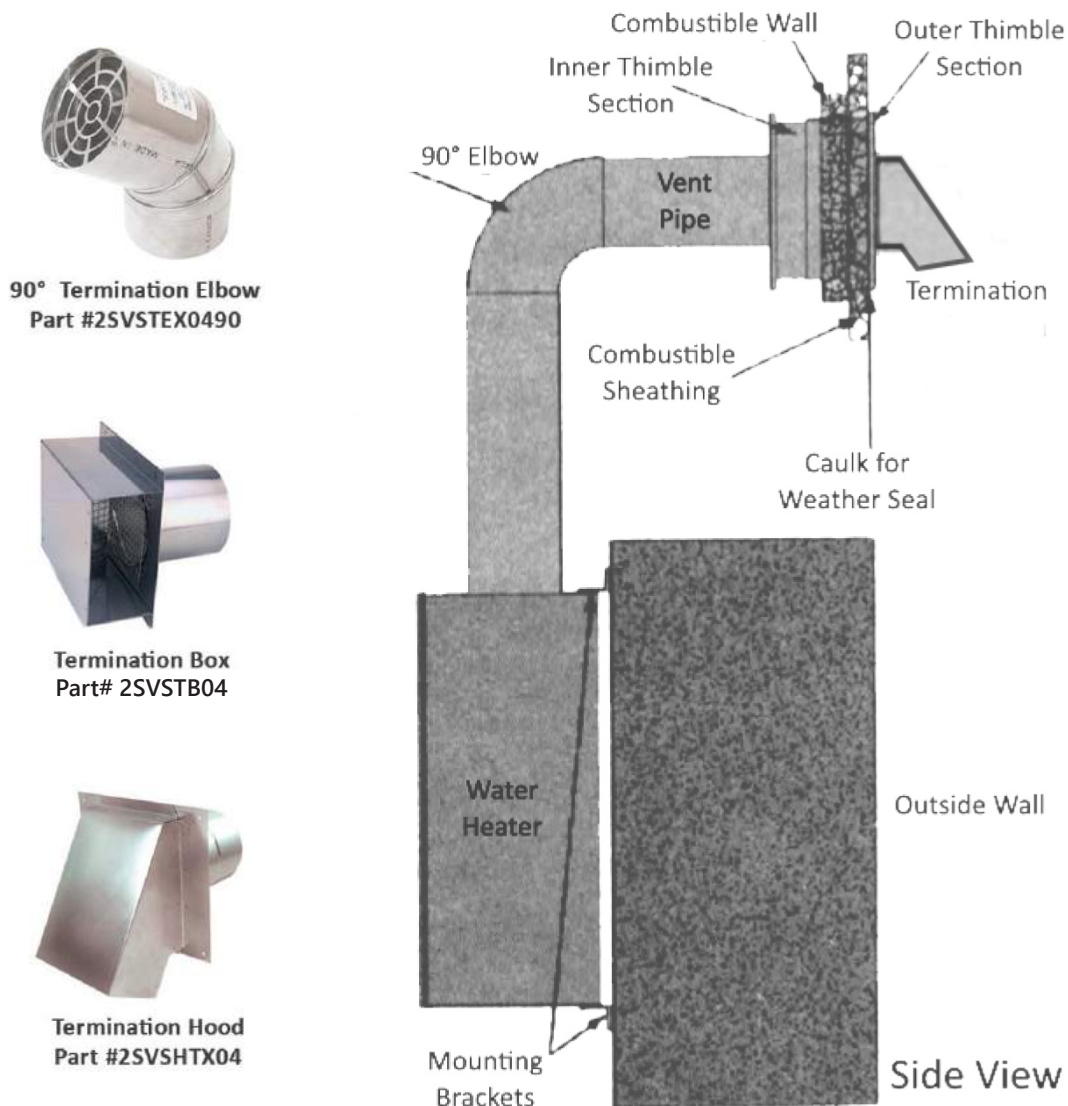

PLEASE NOTE: 45H IS FOR OUTDOOR PERMANENT INSTALLATIONS ONLY AND 45HI IS FOR INDOOR PERMANENT INSTALLATIONS ONLY. THIS MANUAL AND ALL ECCOTEMP CONTACT IS SUBJECT TO CHANGE WITHOUT NOTICE. PLEASE VISIT WWW.ECCOTEMP.COM/SUPPORT FOR MORE INFORMATION.



45-HI

Installing the 45-HI water heater, Continued...

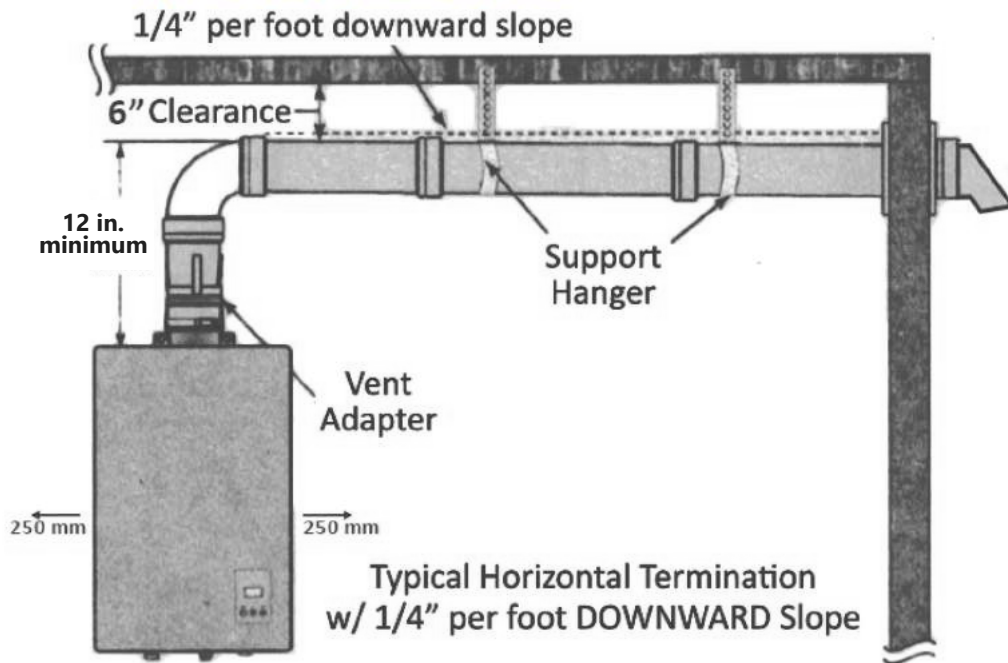

⚠ WARNING: Use UL approved Category III vent material only. No other vent material is permitted. Owner must refer to vent manufacturer's instructions and specifications. Z-Flex information can be found at www.novaflex.com, refer to page 19 for additional links.

⚠ CAUTION: Follow the vent manufacturers installation instructions as design might vary om manufacturer to manufacturer.

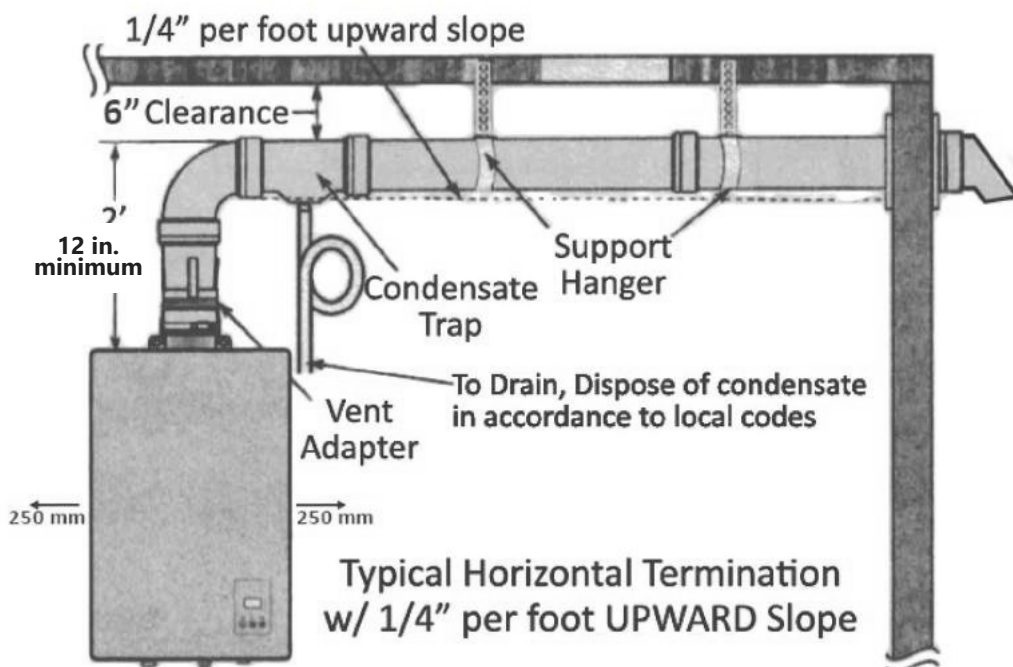
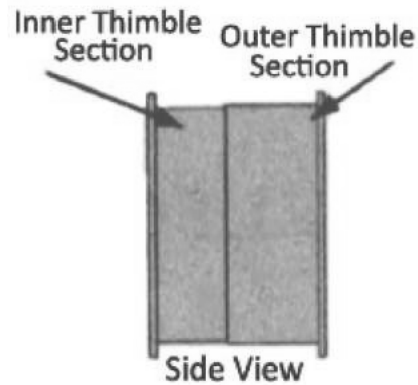

PLEASE NOTE: 45H IS FOR OUTDOOR PERMANENT INSTALLATIONS ONLY AND 45HI IS FOR INDOOR PERMANENT INSTALLATIONS ONLY. THIS MANUAL AND ALL ECCOTEMP CONTACT IS SUBJECT TO CHANGE WITHOUT NOTICE. PLEASE VISIT WWW.ECCOTEMP.COM/SUPPORT FOR MORE INFORMATION.



⚠ WARNING : Field wiring connections and electrical grounding must comply with local codes, or in the absence of local codes, with the latest edition of the National Electrical Code, ANSI/NFPA 70, or in Canada, Canadian Electrical Code, CSA C22.1 Part 1

Remote Control Installation

The following are considerations for determining the location of the remote control(s):

- **DO NOT** install any remote control outdoors.
- Place remote control(s) out of children's reach.
- The remote control(s) can be installed in convenient locations such as the kitchen, laundry room, or utility room.
- The included remote control can be placed in a convenient location in a bathroom, however, AVOID areas where water may come into contact with the control(s).
- Avoid areas where the remote control(s) may be exposed to heat, e.g. stove ranges or heaters.
- Avoid areas where the remote control(s) may be subjected to oil and/or steam from cooking.
- Avoid areas where chemical agents (such as thinner, benzine and alkaline) are used.
- Avoid areas of direct sunlight.
- The MAXIMUM distance between the water heater and the remote control(s) installation location is limited to 50 feet.
- No other manufacturer's controls are suitable for use with this water heater.
- **DO NOT** attempt to disassemble the remote control.

(Optional) Eccotemp Remote control - Connection, Installation and Set

(For Panel Control/Remote Control and Remote Control units)

Panel Control/Remote Control and Remote Control units will work with either one or two remote controls. If two remotes are desired, a wire connector will need to be provided. To connect the remote control:

1. For one control: Plug the aviation joint into the socket directly on the water heater (see illustration below)

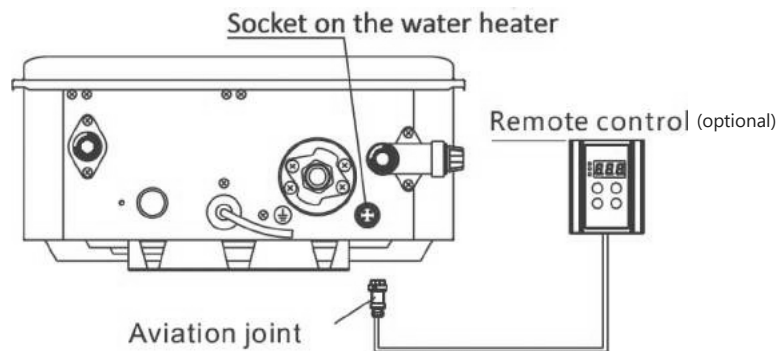

2. For two controls: First, cut off the aviation joints on the two controllers, plug one into the socket on the water heater (length is dependent on your requirements), and throw away the other. Then connect the wires of the aviation joint to the inlet wire of the connector, and connect the two remote control to the outlet wires of connector.

PLEASE NOTE: 45H IS FOR OUTDOOR PERMANENT INSTALLATIONS ONLY AND 45HI IS FOR INDOOR PERMANENT INSTALLATIONS ONLY. THIS MANUAL AND ALL ECCOTEMP CONTACT IS SUBJECT TO CHANGE WITHOUT NOTICE. PLEASE VISIT WWW.ECCOTEMP.COM/SUPPORT FOR MORE INFORMATION.



Installation of Remote Control

1. Remove the front cover of the Remote Control. (See illustration below)

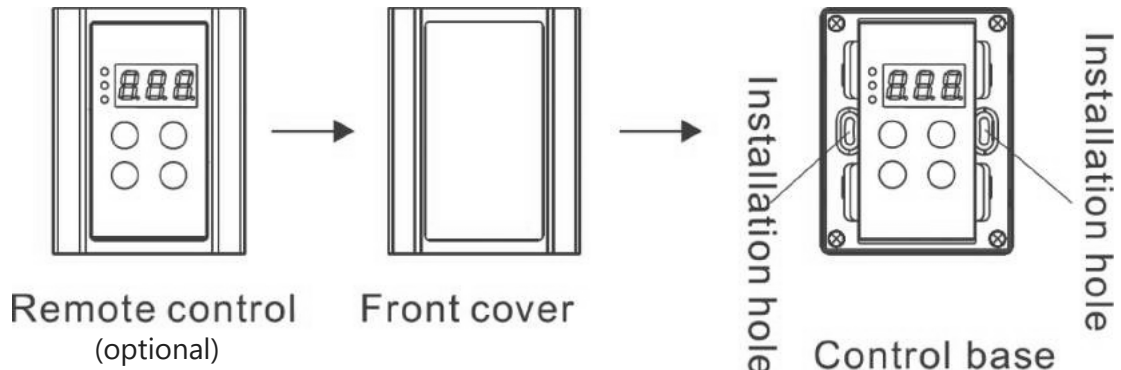

2. At installation site, mark and screw two holes with 0.24" with 1.2" depth. Insert 2 rubber screws into the holes. Place the remote control against the wall, align the holes of control with the holes in the wall, and fasten them with wood thread screws. (See illustration below)

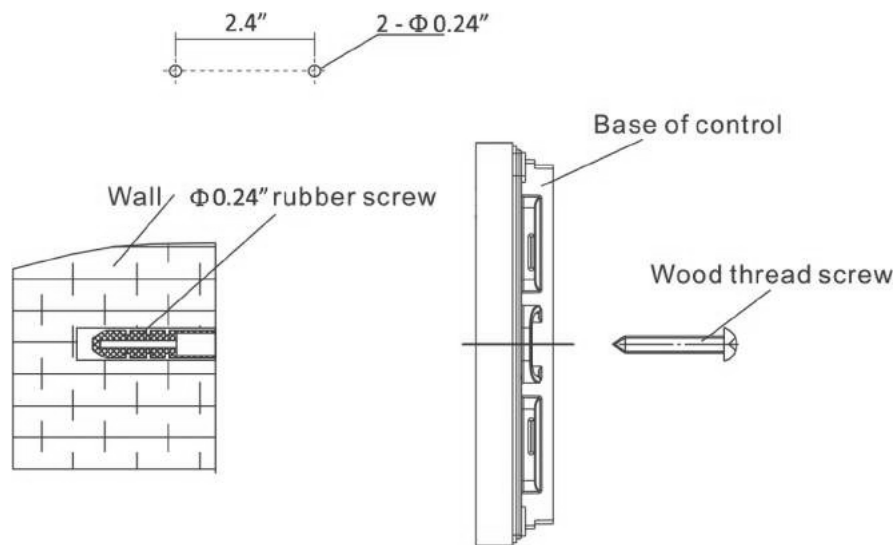

3. Replace the front cover on the remote control.

PLEASE NOTE: 45H IS FOR OUTDOOR PERMANENT INSTALLATIONS ONLY AND 45HI IS FOR INDOOR PERMANENT INSTALLATIONS ONLY. THIS MANUAL AND ALL ECCOTEMP CONTACT IS SUBJECT TO CHANGE WITHOUT NOTICE. PLEASE VISIT WWW.ECCOTEMP.COM/SUPPORT FOR MORE INFORMATION.



⚠ WARNING :Field wiring connections and electrical grounding must comply with local codes, or in the absence of local codes, with the latest edition of the National Electrical Code, ANSI/NFPA 70, or in Canada, Canadian Electrical Code, CSA C22.1 Part 1.

Electrical Connection

POWER CORD:

- The electric power supply requirement for this water heater is 120 VAC/60HZ, 2 Amps.
- The water heater comes with a three (3) pin power supply cord. Use only a power outlet with a ground terminal.
- The installation of an electric leakage breaker is recommended. (GFCI)
- Keep any excess of the power supply cord on the outside of the water heater.
- If local codes require hardwiring, see instructions for "Hardwiring the Electrical Connections".

⚠ WARNING: Shock hazard line voltage is present. Before servicing the water heater, turn off the electrical power to the water heater at the main disconnect or circuit breaker. Failure to do so could result in severe personal injury or death.

HARDWIRING THE ELECTRICAL CONNECTIONS:

- Wiring should be carried out by a qualified electrician in accordance with local codes.
- The water heater requires 120 VAC/60Hz and should be properly grounded.
- DO NOT connect grounding wire to water pipes, gas pipes, telephone cables, lightning conductor circuits and to grounding circuit of other equipment that carry a ground-fault interrupter.
- An ON/OFF switch must be provided and installed for the incoming 120VAC power.
- Wire the water heater exactly as shown below. A wiring diagram is also found inside of the cover panel.
- A green screw is provided in the junction box for grounding connection.
- Connect the live wire to black leg wire and the neutral wire to the white neutral wire.

⚠ CAUTION: Label all wires prior to disconnection when servicing controls. Wiring errors can cause improper and dangerous operation. Verify correct operation after servicing.

Electric Wiring Diagram

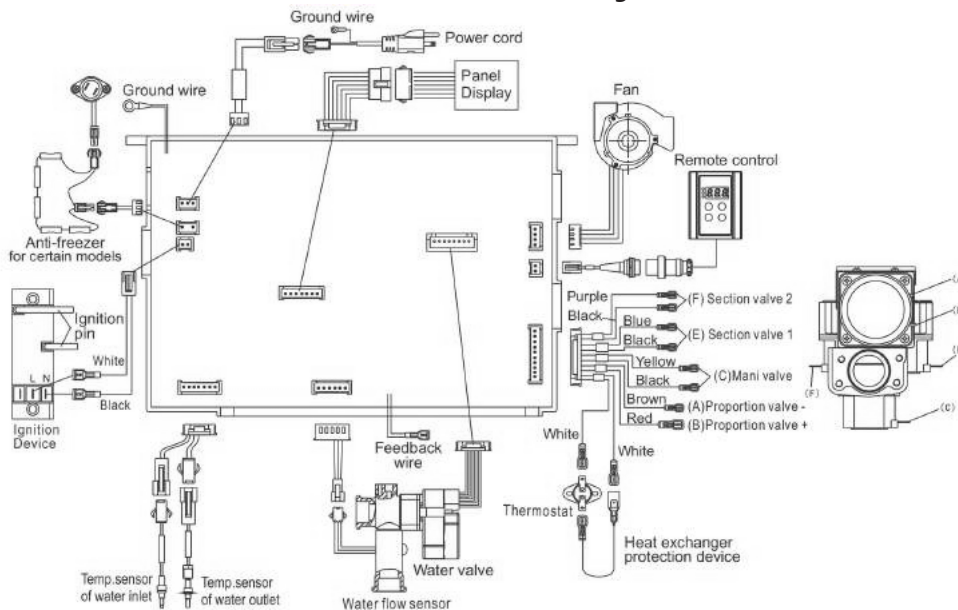

PLEASE NOTE: 45H IS FOR OUTDOOR PERMANENT INSTALLATIONS ONLY AND 45HI IS FOR INDOOR PERMANENT INSTALLATIONS ONLY. THIS MANUAL AND ALL ECCOTEMP CONTACT IS SUBJECT TO CHANGE WITHOUT NOTICE. PLEASE VISIT WWW.ECCOTEMP.COM/SUPPORT FOR MORE INFORMATION.



45-HI

Insulation Blankets

⚠ WARNING: If local codes require external application of insulation blanket kits the manufacturer's instructions included with the kit must be carefully followed.

Insulation blankets, available to the general public, for external use on gas water heaters are not necessary. The purpose of an insulation blanket is to reduce the standby heat loss encountered with storage tank heaters. This water heater does not store water making an insulation blanket unnecessary.

The manufacturer's warranty does not cover any damage or defect caused by installation, attachment or use of any type of energy saving

or other unapproved devices (other than those authorized by the manufacturer) into, onto or in conjunction with the water heater.

The use of unauthorized energy saving devices may shorten the life of the water heater and may endanger life and property.

The manufacturer disclaims any responsibility for such loss or injury resulting from the use of such unauthorized devices.

Pipe Installation

Inlet Pipe and Outlet Pipe Installation

Use pressure resistant pipe to connect the inlet and outlet water pipes of the water heater and the local water pipe (Make sure to place the rubber ring). Before connecting the inlet water pipe, flush the inside of the pipe.

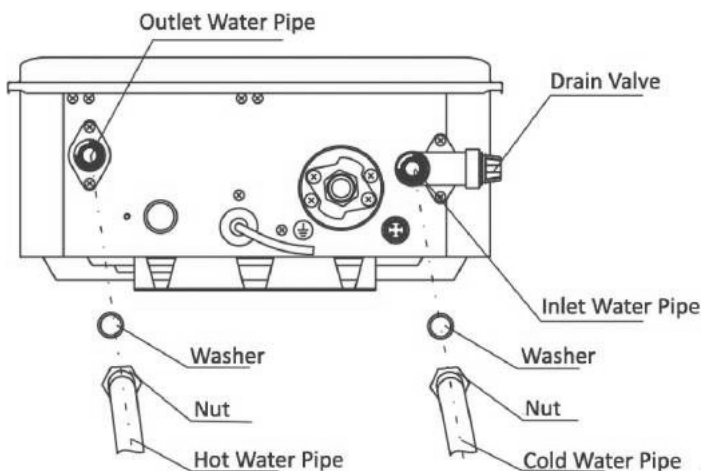

Hot and Cold Pipe

Insulation Installation

For increased energy efficiency, use pipe insulation. Please install the insulation, according to the illustrations above, making sure to insulate all the way to the top. Do not cover any drain or pressure valve(s).

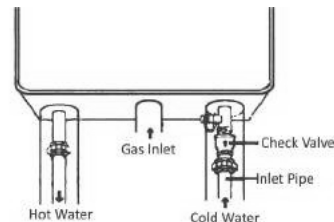

NOTICE: The hot and cold pipes should be insulated as shown help to provide additional freeze protection

During Installation of this water heater

Do's

- **DO** check inlet gas pressure to ensure that it is within the range specified on the rating plate.
- **DO** provide adequate air for combustion and ventilation as discussed in the Use & Care Manual and the National Gas Code (CAN/CGA B 149 in Canada).
- **DO** maintain proper clearances to combustibles as specified by applicable code.
- **DO** ensure that the flue terminal location complies with the guidelines found in the Use & Care Manual and National Fuel Gas Code (CAN/CGA B 149 in Canada).

Dont's

- **DON'T** block or restrict Air Intake Opening located on the back side of the water heater.
- **DON'T** remove the front cover unless absolutely necessary. This should only be done after being examined by a qualified service technician.
- **DON'T** install this product where standing water may occur.

PLEASE NOTE: 45H IS FOR OUTDOOR PERMANENT INSTALLATIONS ONLY AND 45HI IS FOR INDOOR PERMANENT INSTALLATIONS ONLY. THIS MANUAL AND ALL ECCOTEMP CONTACT IS SUBJECT TO CHANGE WITHOUT NOTICE. PLEASE VISIT WWW.ECCOTEMP.COM/SUPPORT FOR MORE INFORMATION.



45-HI

Mounting the 45-HI Water Heater

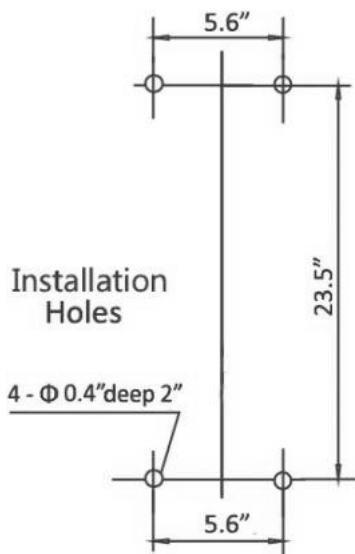

Make sure the location of the water heater allows for easy access and operation.

In case of dry wall or concrete wall use dry wall anchors or lag bolts.

The water heater requires 120VAC/ 60Hz. Have a receptacle with ground terminal near the water heater. The length of the power supply cord is 5 feet.

Drill the holes as per the sizes in the figure to the left, put 2 expansion screws into the top holes, and 2 rubber screws into the bottom holes.

Hang up the water heater unit, tighten the expansion screws, and put 2 wood thread screws into the bottom holes.

⚠ CAUTION: Reinforcement of the wall is required in case the wall is not strong enough to hold the water heater.

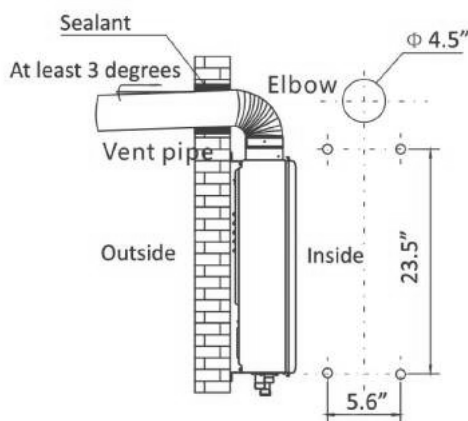

Back installation

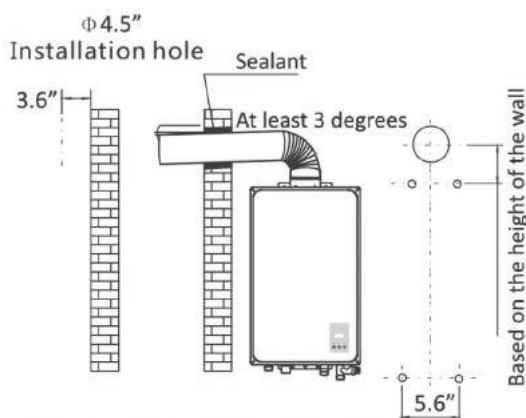

Side installation

*Reference Vent Manufacturer Component Information - Page 19

Indoor unit must be installed with CAT 3 vent pipe in accordance with vent supplier/ Manufacturer in accordance with local code. Owner must refer to vent manufacturer's instructions and specifications. Z-Flex information can be found at www.novaflex.com, please refer to page 19 for additional links.

A. BACK INSTALLATION

1. Insert the vent pipe through the installation holes in the wall with the terminal sticking out.
2. Connect the elbow to the vent pipe and water heater, moving straight backwards until the expansion screws go into the holes of the water heater. Screw the nuts tight (pay attention to the direction of the elbow).

B. SIDE INSTALLATION:

1. Aim the holes in the water heater onto the expansion screws, hang it up and screw the nuts tightly.
2. Put the vent pipe through the holes in the wall, and connect the elbow with the water heater and vent pipe.

C. VERTICAL INSTALLATION

Please refer to local installation professional or venting manufacturer:

The installation hole in the wall needs to be sealed by fire-retardant material or wall thimble, making sure the water heater is tight and will not come off.

PLEASE NOTE: 45H IS FOR OUTDOOR PERMANENT INSTALLATIONS ONLY AND 45HI IS FOR INDOOR PERMANENT INSTALLATIONS ONLY. THIS MANUAL AND ALL ECCOTEMP CONTACT IS SUBJECT TO CHANGE WITHOUT NOTICE. PLEASE VISIT WWW.ECCOTEMP.COM/SUPPORT FOR MORE INFORMATION.



Installing the 45-HI water heater

Installation Check List

A. Water Heater Location

- Installed indoors.
- Close to area of mostly used outlet.
- Protected from freezing temperatures.
- Proper clearance from combustible surfaces observed.
- Sufficient fresh air supply for proper operation of water heater.
- Air supply free of corrosive elements and flammable vapors.
- Provisions made to protect area from water damage.
- Sufficient room to service heater.
- Combustible materials, such as clothing, cleaning materials, rags, etc. clear of the heater and vent piping.
- Water heater is properly attached to the wall.

B. Water Supply

- Water supply has sufficient pressure.
- Air purged from water heater and piping.
- Water connections tight and free of leaks
- Water filter is clean and in place.
- Materials used are as instructed in this manual.
- Water pipes are insulated.

C. Gas Supply

- Gas type matches rating plate.
- Gas supply pressure is sufficient for the water heater.
- Gas line equipped with shut-off valve, union and sediment trap.
- Approved pipe joint compound used.
- Commercial leak detector or soap and water solution used to check all connections and fittings for possible gas leak.
- Gas Company inspected installation (if required).

D. Relief Valve

- Pressure Relief Valve properly installed and discharge line run to open drain
- Discharge line protected from freezing.

E. Electrical Wiring

- Voltage matches rating plate.
- Water heater is properly grounded .
- Wiring meets all local codes.
- GFCI Protection where required.

PLEASE NOTE: 45H IS FOR OUTDOOR PERMANENT INSTALLATIONS ONLY AND 45HI IS FOR INDOOR PERMANENT INSTALLATIONS ONLY. THIS MANUAL AND ALL ECCOTEMP CONTACT IS SUBJECT TO CHANGE WITHOUT NOTICE. PLEASE VISIT WWW.ECCOTEMP.COM/SUPPORT FOR MORE INFORMATION.



Lighting the Water Heater

Before operating this water heater, be sure to read and follow the instructions on the label pictured below and all other labels on the water heater, as well as the warnings printed in this manual. Failure to do so can result in unsafe operation of the water heater resulting in property damage, personal injury, or death. Should you have any problems reading or following the instructions in this manual. STOP, and get help from a qualified person.

FOR YOUR SAFETY BEFORE USING THE WATER HEATER

⚠ WARNING: If you do not follow these instructions exactly, a fire or explosion may result causing property damage, personal injury or loss of life.

- A. This water heater does not have a pilot. It is equipped with an ignition device which automatically lights the burner. Do not try to light the burner by hand.
- B. BEFORE OPERATING smell all around the water heater area for gas. Be sure to smell next to the floor because some gas is heavier than air and will settle on the floor. Test all connections with a commercial leak detector or soapy water.

WHAT TO DO IF YOU SMELL GAS

- **DO NOT** try to light any appliance • **DO NOT** touch any electric switch; **DO NOT** use any phone in your building. • Immediately call your gas supplier from a neighbor's phone. Follow the gas supplier's instructions. • If you cannot reach your gas supplier or fire department. • **DO NOT** return to your home until authorized by the gas supplier or fire department.
- C. Use only your hand to push in or turn the gas control knob. Never use tools. If the knob will not push in or turn by hand, don't try to repair it, call a qualified service technician. Force or attempted repair may result in a fire or explosion.
 - D. **DO NOT** use this water heater if any part has been under water. Immediately call a qualified service technician to inspect the water heater and to replace any part of the control system and any gas control which has been under water.

OPERATING INSTRUCTIONS

1. STOP! Read the safety information above on this label.
2. Turn off all electric power to the water heater.
3. Set the thermostat to lowest setting.
4. DO NOT attempt to light the burner by hand.
5. Turn the Gas Shut-off Valve located on the outside of the unit clockwise to the "OFF" position.
6. Wait five (5) minutes to clear out any gas. If you smell gas, STOP! Follow "B" in the safety information above on this label. If you don't smell gas, go to the next step.
7. Turn the Gas Shutoff Valve located on outside of the unit counterclockwise to the "ON" position.
8. Turn on all electric power to the water heater.
9. Set thermostat to desired setting.
10. If the water heater will not operate, follow the instructions "To Turn Off Gas To water heater" and call your service technician or gas supplier.



TO TURN OFF GAS TO WATER HEATER

1. Turn off all electric power to the water heater if service is to be performed.
2. Turn the Gas Shut-off Valve located on the outside of the unit clockwise to the "OFF" position.

PLEASE NOTE: 45H IS FOR OUTDOOR PERMANENT INSTALLATIONS ONLY AND 45HI IS FOR INDOOR PERMANENT INSTALLATIONS ONLY. THIS MANUAL AND ALL ECCOTEMP CONTACT IS SUBJECT TO CHANGE WITHOUT NOTICE. PLEASE VISIT WWW.ECCOTEMP.COM/SUPPORT FOR MORE INFORMATION.



Operating the Water Heater.

Turning on the Water Heater

1. Make sure the gas type you will use is same as the type on the data plate.
2. Turn on the main gas valve, plug in the power cord (be sure the socket is well grounded), and press the "ON/OFF" button on the control panel. Set temperature to 120° F.
3. Turn on the faucet, and the fan will begin working. You will hear the ignition sound after a few seconds. The burner will ignite, and hot water will come out. If the burner is not ignited successfully, the ignition sound will last a few seconds. If the burner still fails to ignite, turn off the faucet and wait for 10-20 seconds, and repeat the above procedures.

For first use and/or if the water heater has not been used for a considerable period of time, the repeat of the above procedures may be required, due to accumulated air inside the gas pipe.

Safety Precautions

If there is any difficulty in understanding or following the Operating Instructions or the Care and Cleaning section, it is recommended that a qualified person or serviceman perform the work.

- DO turn off manual gas shut-off valve if water heater has been subjected to over heating, fire, flood, physical damage or if the gas supply fails to shut off.
- DO NOT turn on water heater unless water and gas supplies are fully opened.
- DO NOT turn on water heater if cold water supply shut-off valve is closed.
- DO NOT allow combustible materials such as newspaper, rags or mops to accumulate near water heater.
- DO NOT store or use gasoline or other flammable vapors and liquids, such as adhesives or paint thinner, in vicinity of this or any other appliance. If such flammables must be used, open doors and windows for ventilation, and all gas burning appliances in the vicinity should be shut off including their pilot lights, to avoid vapors lighting.

NOTICE: Flammable vapors can be drawn by air currents from surrounding areas to the water heater

PLEASE NOTE: 45H IS FOR OUTDOOR PERMANENT INSTALLATIONS ONLY AND 45HI IS FOR INDOOR PERMANENT INSTALLATIONS ONLY. THIS MANUAL AND ALL ECCOTEMP CONTACT IS SUBJECT TO CHANGE WITHOUT NOTICE. PLEASE VISIT WWW.ECCOTEMP.COM/SUPPORT FOR MORE INFORMATION.



Water Temperature Setting

⚠️ DANGER: There is a hot water scald potential if the temperature is set too high. Households with small children, disabled, or elderly persons may require a 120°F. or lower temperature setting to prevent contact with HOT water.

Water Temperature	Time To Produce a Serious Burn
120°F	More than 5 minutes
125°F	1 1/2 to 2 minutes
130°F	About 30 seconds
135°F	About 10 seconds
140°F	Less than 5 seconds
145°F	Less than 3 seconds
150°F	About 1 1/2 seconds
155°F	About 1 second

Table courtesy of Shriners Burn Institute

Output temperature of water is regulated by setting the temperature on the front of the remote control.

Safety factors should be considered when selecting the water temperature setting of the water heater's remote control. The remote control was set at 110°F before the water heater was shipped from the factory. This is the recommended starting point.

Water temperatures above 120°F can cause severe burns or death from scalding. The thermostat is adjusted to its lowest temperature position when shipped from the factory.

Be sure to read and follow the warnings outlined in this manual and on the label located on the water heater. Mixing valves are available for reducing point of use water temperature by mixing hot and cold water in branch water lines.

Procedures for adjusting the thermostat for energy efficient operation at the minimum water temperature setting consistent with the consumer's needs.

Contact a licensed plumber or the local plumbing authority for further information. See page 4 for details.

Set Temperature Memory:

1. This model can memorize and save the last set temperature on the remote control with "priority".
 2. If no remote control has "priority", the set temperature of the unit will be the same as the set temperature of the remote control which starts the water heater.
- This water heater contains an electronically controlled thermostat. From the factory, the temperature range is between 90°F and 140°F.
 - The remote control is factory preset to 110°F.
 - To turn the remote control ON or OFF, press the POWER button for more than 3 seconds.
 - To adjust the temperature to a required setting, in "priority" mode, press the UP or DOWN temperature button. Press and hold UP or DOWN to raise or lower the temperature continuously.
 - When the unit is in use, the set temperature can increase to 122°F, but there is no limit to temperature decrease. To increase the temperature more than 122°F, the water will need to be shut off first.
 - The display will read the set temperature if the water heater is not in use or there is no water flow. If the water heater is in use or has water flow, the display will read the actual temperature. To view the set temperature in this condition, press UP or DOWN and the set temperature will flash for 3 seconds.
 - The hottest temperature water will be at the hot water faucet closest to the water heater
 - Always remember to test the water temperature with your hand before use and remember that hotter water increases the risk of scald injury.
 - Always supervise young children or others who are incapacitated.
 - If the water heater has been subjected to fire, flood or physical damage, turn off the manual gas shut-off valve(s), and do not operate the water heater again until it has been checked by qualified personnel.

NOTICE: If inlet water temperature is high, and set temperature is low, the actual temperature might be higher than the set temperature, and vice versa..

⚠️ WARNING: Should overheating occur or the gas supply fail to shut off, turn off the manual gas control valve to the water heater.

⚠️ NOTICE: If the BATH control is turned on, the temperature setting on the MAIN control cannot be changed. The BATH control(s) will always have PRIORITY over the MAIN control.

PLEASE NOTE: 45H IS FOR OUTDOOR PERMANENT INSTALLATIONS ONLY AND 45HI IS FOR INDOOR PERMANENT INSTALLATIONS ONLY. THIS MANUAL AND ALL ECCOTEMP CONTACT IS SUBJECT TO CHANGE WITHOUT NOTICE. PLEASE VISIT WWW.ECCOTEMP.COM/SUPPORT FOR MORE INFORMATION.



Care and cleaning of the water heater.

Routine Preventative Maintenance

⚠ DANGER: Before manually operating the relief valve, make certain no one will be exposed to the danger of the hot water released by the valve. The water may be hot enough to create a scald hazard. The water should be released into a suitable drain to prevent injury or property damage.

⚠ DANGER: Hotter water increases the potential for Hot Water Scalds.

⚠ DANGER: Failure to perform the recommended Routine Preventative Maintenance can harm the proper operation of this water heater, which can cause carbon monoxide dangers, excessive hot water temperatures and other potentially hazardous conditions.

Properly maintained, your water heater will provide years of dependable trouble-free service. It is recommended that a periodic inspection of the burner, relief valve, water filter and venting system should be made by service personnel qualified in gas appliance repair.

It is suggested that a routine preventive maintenance program be established and followed by the user.

At least once a year, lift and release the lever handle on the pressure relief valve, located in the hot outlet piping of the water heater, to make certain the valve operates freely. Allow several gallons to flush through the discharge line to an open drain.

Rapid closing of faucets or solenoid valves in automatic water using appliances can cause a banging noise heard in a water pipe. Strategically located risers in the water pipe system or water hammer arresting devices can be used to minimize the problem.

Inspect the area around the water heater to ensure a safe operating environment. Keep water heater area clear and free from combustible materials, gasoline, and other flammable vapors and liquids. Ensure the unit has not been damaged. If damage or denting is present, contact a service personnel to verify proper operation.

Check for any abnormal sounds during normal operation of the water heater.

All piping should be checked for gas and/or water leaks. Refer to page 12 of this manual for instructions on leak testing.

The air intake and cold water supply filters should be cleaned monthly. Refer to the "Housekeeping" section for further information.

DO NOT operate the water heater if you feel something is wrong with the unit.

DO NOT allow children to operate or otherwise handle the unit.

NOTICE: If the pressure relief valve on the hot water heater discharges periodically, this may be due to a problem in the water system. Contact the water supplier or your plumbing contractor on how to correct this. DO NOT plug the relief valve outlet.

NOTICE: After inspection, maintenance, and/ or cleaning, ensure proper operation by turning on a hot water faucet.

Housekeeping

HOW TO CLEAN THE WATER FILTER:

1. Make sure the unit is OFF and the electrical power supply has been disconnected.
2. Turn the water supply OFF to the heater.
3. Unscrew the water filter, and slide the filter out.
4. **DO NOT** tap the filter as it may deform and/or damage the filter.
5. To remove severe dust, use a soft brush and wash with running water.
6. Return the filter to the water heater and screw in the filter.
7. Turn the electrical power supply and cold water supply ON to the water heater

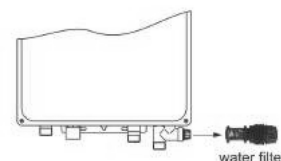

6 MONTH CLEANING ROUTINE

To prevent water scale, lime or rust deposit buildup and ensure your Eccotemp tankless water heater is running as efficiently as possible it is highly recommended that you clean your Eccotemp tankless water heater every 6 months. To do this we recommend that you use our Eccotemp EZ-Flush System Descaler Kit. For more information and to purchase please visit us at www.eccotemp.com or call 1-866-356-1992.

PLEASE NOTE: 45H IS FOR OUTDOOR PERMANENT INSTALLATIONS ONLY AND 45HI IS FOR INDOOR PERMANENT INSTALLATIONS ONLY. THIS MANUAL AND ALL ECCOTEMP CONTACT IS SUBJECT TO CHANGE WITHOUT NOTICE. PLEASE VISIT WWW.ECCOTEMP.COM/SUPPORT FOR MORE INFORMATION.



Housekeeping continued...

Before performing any Housekeeping tasks to this water heater, be sure to turn the unit off and disconnect the power supply.

Vacuum around the water heater for dust, dirt and lint on a regular basis. Clean the water heater and remote control by using a damp soft cloth with a few drops of mild detergent and gently wiping the surfaces of the unit. Wipe any remaining moisture with a dry soft cloth.

To ensure sufficient ventilation and combustion air supply, proper clearances must be maintained. The water filters should be cleaned on a monthly basis. Combustion system is fan-assisted

CLEANING THE WATER HEATER AND REMOTE CONTROL(S):

- Make sure the unit is OFF and the electrical power supply has been disconnected.
- **DO NOT** scrub the appliance with a brush.
- Use only mild soapy water, other cleaners may damage the surface of the water heater.
- **DO NOT** remove any label including the rating plate while cleaning or servicing.
- **DO NOT** splash water on the remote controls when cleaning.

⚠ DANGER: Shock Hazard. Make sure the electrical power to the water heater is off to avoid potential serious injury or damage to components.

⚠ DANGER: Combustible materials, such as clothing, cleaning materials, or flammable liquids, etc., must not be placed against or next to the water heater.

Vacation and Extended Shut-Down

If the water heater is to remain idle for an extended period of time, the power and water to the appliance should be turned off.

The water heater and piping should be drained if they might be subjected to freezing temperatures.

After a long shut-down period, the water heater's operation and controls should be checked by qualified service personnel.

Anti-Freezing

While the Anti-Freezers will help to protect from cold temperatures, they will in no way guarantee protection from freeze damage. DO NOT rely on the Anti-Freezers to fully protect the unit from freezing, take all precautions to prevent cold damage.

NOTICE: The anti-freezing device works for the water heater unit only, and not for the inlet and outlet water pipes.

*** Freezing anywhere in the plumbing system can result in damage to the water heater, such as a rupture in your Heat Exchanger. All pipes must be adequately protected from freezing.**

Units with Anti-Freezers have an automatic heating device and will help to avoid freeze damage, but the power must be kept on. Freezing will occur with no power. In very cold areas and when the temperature is under 32°F, or in event of an ice storm, freezing will occur as the heating power limit is exceeded. If these conditions take place, please follow the procedures explained below.

Draining Procedure

When the temperature falls below 32°F, water in your plumbing system or water heater can turn to ice and then expand causing damage to the water heater. This damage is not covered under your manufacturer's warranty. If these conditions are anticipated, please drain the water heater as follows to help but not guarantee from freezing:

1. Shut off the main gas valve and power
2. Shut off the inlet water valve
3. Open all faucets
4. Take off the drain valve, and allow water to drain for 3 minutes or until the unit is empty.
5. Making sure all water is out, replace the drain valve, and shut off the faucets.

PLEASE NOTE: 45H IS FOR OUTDOOR PERMANENT INSTALLATIONS ONLY AND 45HI IS FOR INDOOR PERMANENT INSTALLATIONS ONLY. THIS MANUAL AND ALL ECCOTEMP CONTACT IS SUBJECT TO CHANGE WITHOUT NOTICE. PLEASE VISIT WWW.ECCOTEMP.COM/SUPPORT FOR MORE INFORMATION.



Care and cleaning of the 45-H water heater.

Draining the Water Heater

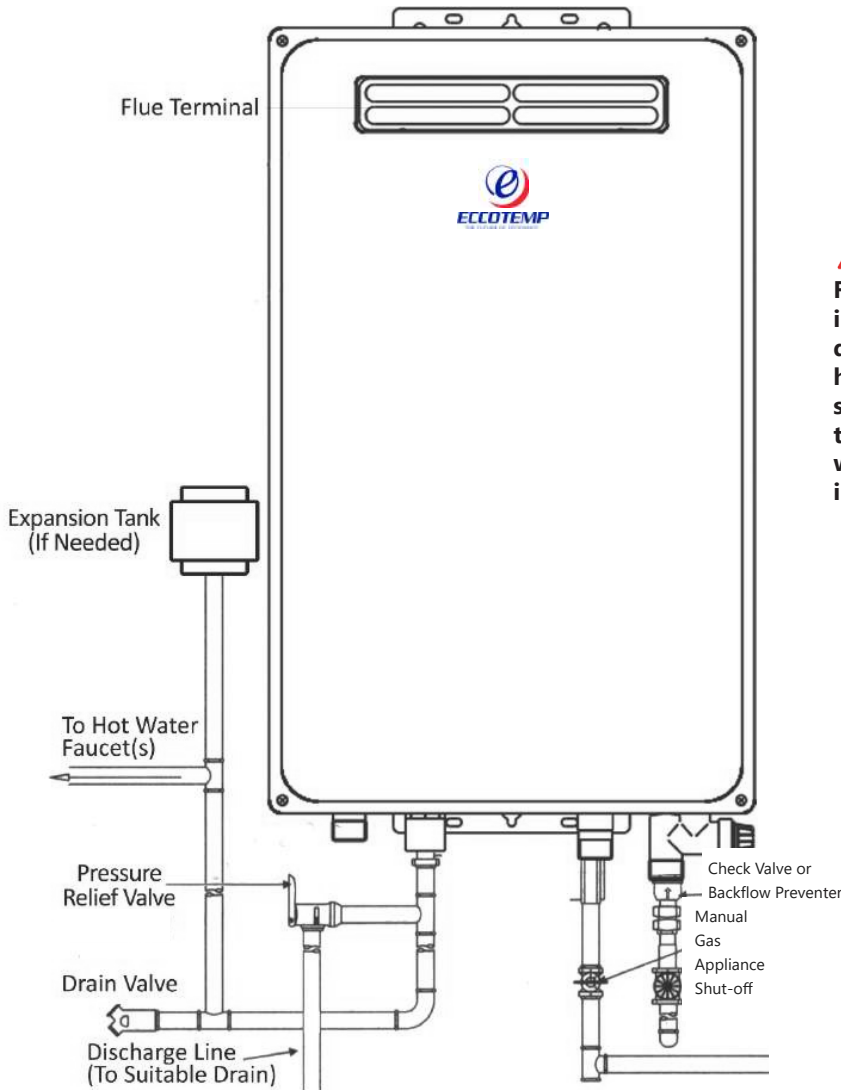

⚠ WARNING:
 Failure to follow these instructions while draining the water heater can cause serious damage to the water heater as well as personal injury including scalding.

Below are instructions for draining water out of the water heater.

1. Turn off the switch on the remote control.
2. Close the gas shut-off valve(s).
3. Close the water shut-off valve.
4. Turn the on/ off switch to the OFF position and disconnect breaker at least 10 seconds after step #1.
5. Open drain valve.
6. Open all hot water faucets. Before proceeding to the next step, make sure that COLD water is coming out of all hot water faucets.
7. To put the water heater back into operation after draining, follow the steps below.
8. Reinstall the water filter. Close the hot water outlet drain valve.
9. Open the water shut-off valve and close again after making sure that water comes out from hot water faucets. (This step is to remove air from the water lines.)
10. Reconnect the breaker and turn the on/off switch to the ON position, fully open the gas shut-off valve and the water shut-off valve.

NOTICE: The water heater may not operate unless the above procedure is followed correctly.

PLEASE NOTE: 45H IS FOR OUTDOOR PERMANENT INSTALLATIONS ONLY AND 45HI IS FOR INDOOR PERMANENT INSTALLATIONS ONLY. THIS MANUAL AND ALL ECCOTEMP CONTACT IS SUBJECT TO CHANGE WITHOUT NOTICE. PLEASE VISIT WWW.ECCOTEMP.COM/SUPPORT FOR MORE INFORMATION.



Care and cleaning of the 45-HI water heater.

Draining the Water Heater

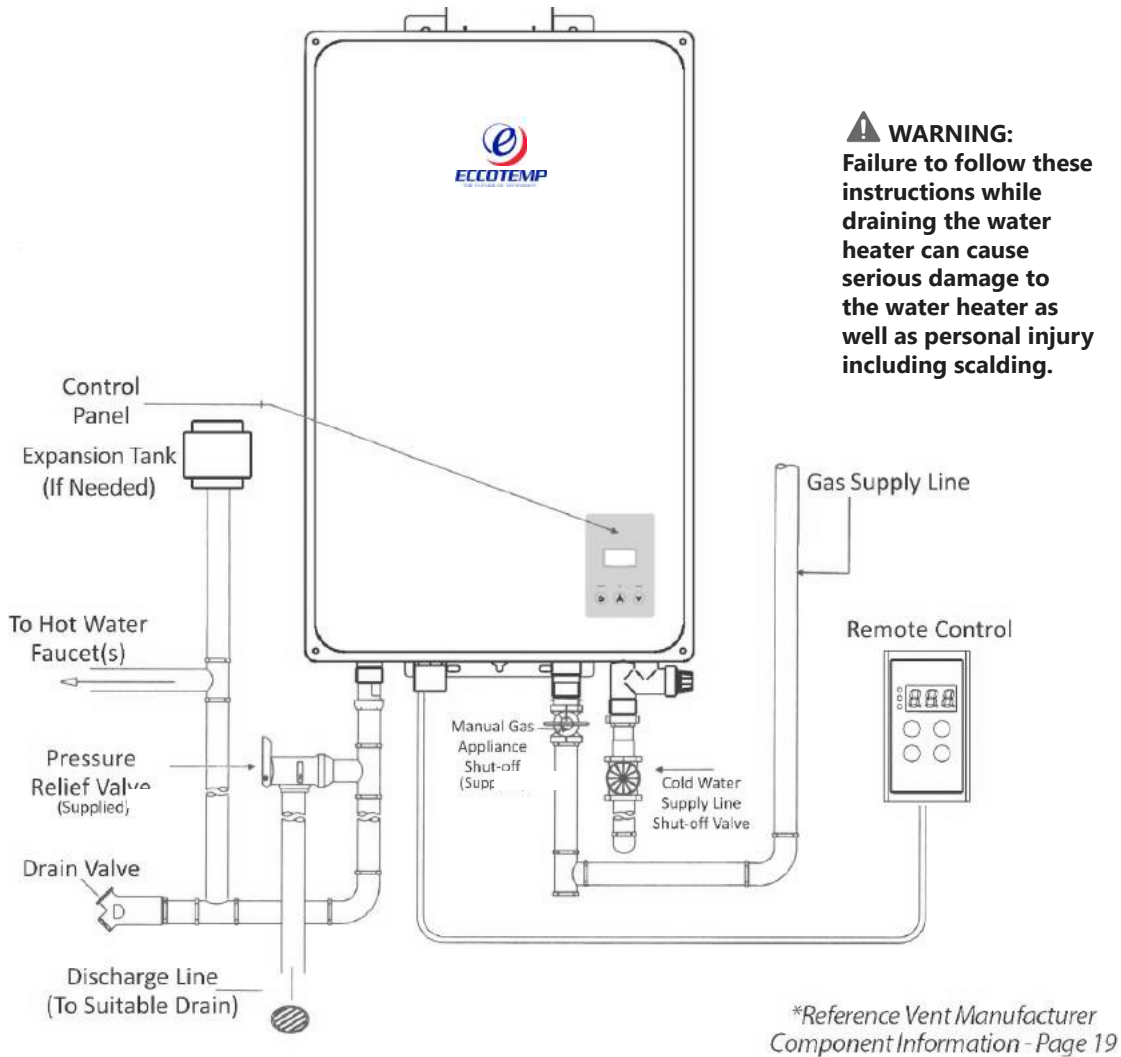

Below are instructions for draining water out of the water heater.

1. Turn off the switch on the remote control.
2. Close the gas shut-off valve(s).
3. Close the water shut-off valve.
4. Turn the on/ off switch to the OFF position and disconnect breaker at least 10 seconds after step #1.
5. Open drain valve.
6. Open all hot water faucets. Before proceeding to the next step, make sure that COLD water is coming out of all hot water faucets.
7. To put the water heater back into operation after draining, follow the steps below.
8. Reinstall the water filter. Close the hot water outlet drain valve.
9. Open the water shut-off valve and close again after making sure that water comes out from hot water faucets. (This step is to remove air from the water lines.)
10. Reconnect the breaker and turn the on/off switch to the ON position, fully open the gas shut-off valve and the water shut-off valve.

NOTICE: The water heater may not operate unless the above procedure is followed correctly.

PLEASE NOTE: 45H IS FOR OUTDOOR PERMANENT INSTALLATIONS ONLY AND 45HI IS FOR INDOOR PERMANENT INSTALLATIONS ONLY. THIS MANUAL AND ALL ECCOTEMP CONTACT IS SUBJECT TO CHANGE WITHOUT NOTICE. PLEASE VISIT WWW.ECCOTEMP.COM/SUPPORT FOR MORE INFORMATION.



Before You Call For Service

Troubleshooting Tips

Save time and money! Review the charts on the following pages first and you may not need to call for service.



This water heater incorporates a variety of shut off devices that prevents the operation of the water heater down if undesirable combustion conditions occur. Such as the presence of a blockage of the combustion air vent insufficient gas or pressure which can impact the safe operation of the water heater. Please contact a Qualified Service Technician if this occurs.

Problem	Possible Cause	What To Do
Not enough or no hot water	Water shutoff valve is not fully opened.	Check shutoff valve and open fully.
	Hot water faucet is not fully opened	Open hot water faucet completely. (The main burner goes off when incoming water volume is inadequate.
	Water piping is frozen	Allow piping to thaw.
	No electricity or water supply is cut off.	Check that proper power is being supplied and/or water supply is adequate.
	Unit is not "ON".	Turn the unit "ON" by the button on the remote control.
	The temperature may be set too low	Increase the temperature setting.
	Mixing Valve malfunction (if applicable).	Check and replace if necessary.
	Error code displayed on remote control panel	See instructions for Error Code and if required, contact a dealer for service.
Water not hot enough..	The temperature may be set too low.	Increase the temperature setting.
	The gas valve is not fully opened.	Check and open the gas valve fully.
Water too hot	The temperature is set too high	Decrease the temperature setting.
	Water shutoff valve is not fully opened.	Check shutoff valve and open fully.
	Small amount of water has been heated.	Allow more water to flow.
	Water filter is clogged	Clean the filter with a tooth brush.
Fan continues to rotate after hot water faucet is closed.	This function is to purge unburned gas 10-15 seconds.	Normal operation. There is no need to call for service. Check for error code.

PLEASE NOTE: 45H IS FOR OUTDOOR PERMANENT INSTALLATIONS ONLY AND 45HI IS FOR INDOOR PERMANENT INSTALLATIONS ONLY. THIS MANUAL AND ALL ECCOTEMP CONTACT IS SUBJECT TO CHANGE WITHOUT NOTICE. PLEASE VISIT WWW.ECCOTEMP.COM/SUPPORT FOR MORE INFORMATION.



Error Code Guide

When an error code is displayed:

- Close the hot water faucet, turn off the switch on the remote control.
- Wait for about 5 minutes before turning the switch on again.
- Open the hot water faucet.

NOTICE: If an error code other than those listed below is displayed, immediately turn off the hot water faucet, take note of the error code, turn off the switch on the remote control and call the customer assistance number.

If the error code remains shown:

- Close the hot water faucet and turn off the switch on the remote control.
- Take the proper action shown below and attempt operation of the water heater again.
- If the error code is still shown:
- Turn off the hot water faucet and turn off the switch on the remote control.
- Take note of the error code displayed and call the customer service assistance number in the "If You Need Service"

Error Code	Error Description	Possible Cause	What To Do
E0	Hot water sensor failure	Junction port loose, Short circuit	Call for Service
E1	Ignition system failure	The gas valve is not opened or fully opened, Water shut-off valve is not open, Junction port loose	Check and open gas fully, Check and open water valve, Call for Service
E2	There is flame when no water coming in	Electric circuit problem	Call for Service
E3	Over-heating protection	Dry Combustion, Problem of over heating controller	Call for Service
E4	Cold water temperature sensor	problem with sensor, problem with sensor's plug or socket, none of the above	replace the sensor, fix it, replace the computer board
E5	Pressure Switch	Motor problem, Voltage of power supply is too low	Call for Service
E6	Over-heating	Gas pressure is too high, Water shutoff valve is not fully opened, The temperature is set too low	Check shut-off valve and open fully, Increase temperature setting
E7	solenoid valve	open circuit of the valve, short circuit of the valve, none of the above	connect the valve, replace the valve, replace the computer board
E8	vent pipe block	vent pipe is blocked	clean the pipe

⚠ CAUTION: For your safety DO NOT attempt repair of gas piping, remote control, burners, vent connectors or other safety devices. Refer repairs to qualified service personnel.

⚠ CAUTION: Make certain power to water heater is "OFF" before removing protective cover FOR ANY REASON.

⚠ CAUTION: Label all wires prior to disconnection when servicing controls. Wiring errors can cause improper and dangerous operation. VERIFY PROPER OPERATION AFTER SERVICING.

PLEASE NOTE: 45H IS FOR OUTDOOR PERMANENT INSTALLATIONS ONLY AND 45HI IS FOR INDOOR PERMANENT INSTALLATIONS ONLY. THIS MANUAL AND ALL ECCOTEMP CONTACT IS SUBJECT TO CHANGE WITHOUT NOTICE. PLEASE VISIT WWW.ECCOTEMP.COM/SUPPORT FOR MORE INFORMATION.



45-H Replacement Parts

Typical Installation (Some Items May Not Apply)

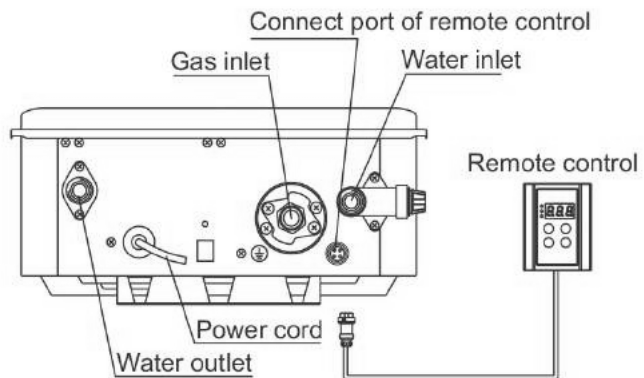
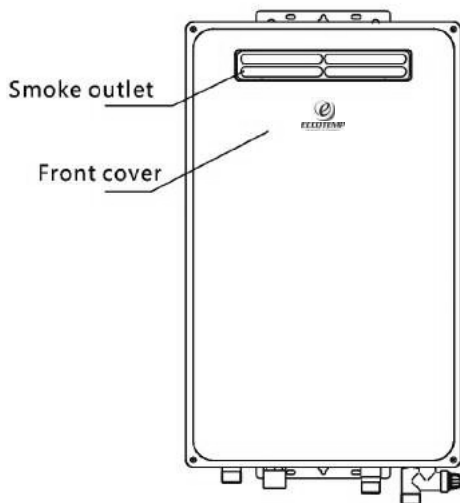
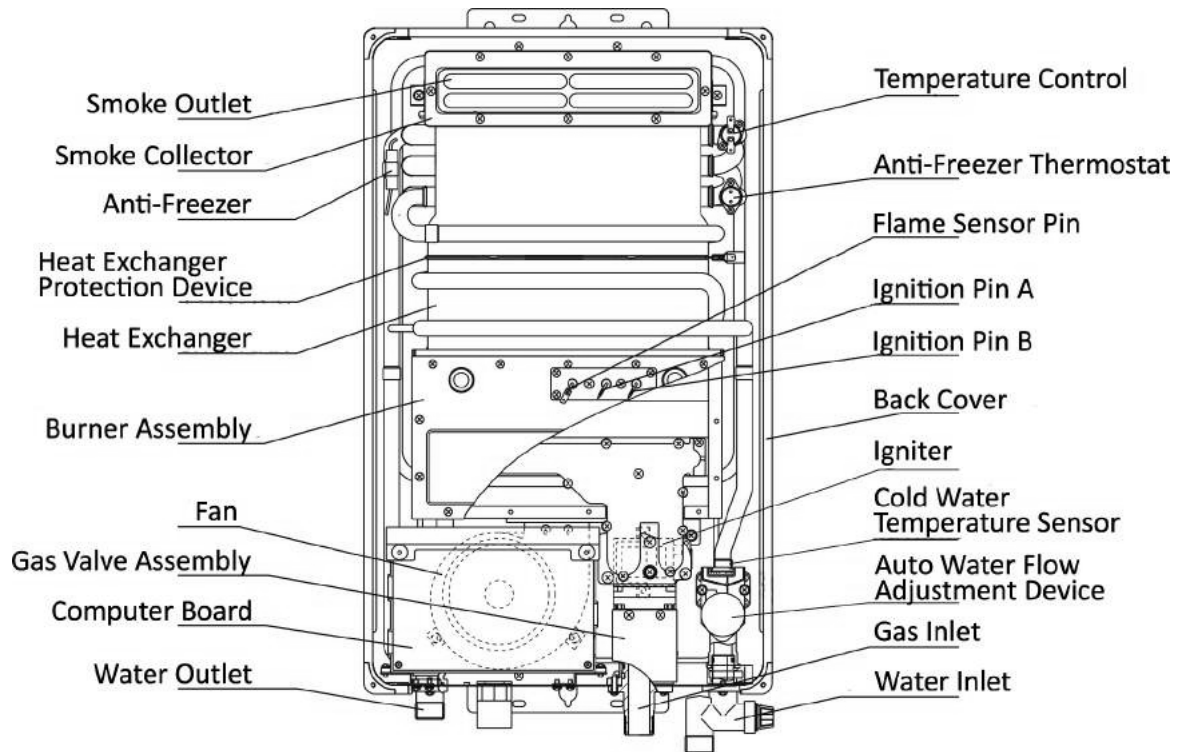

NOTICE: The National Fuel Gas Code (NFGC) mandates a manual gas shut- off valve: See (NFGC) for complete instructions. Local codes or plumbing authority requirements may vary from the instructions or diagrams provided and take precedent over these instructions.

PLEASE NOTE: 45H IS FOR OUTDOOR PERMANENT INSTALLATIONS ONLY AND 45HI IS FOR INDOOR PERMANENT INSTALLATIONS ONLY. THIS MANUAL AND ALL ECCOTEMP CONTACT IS SUBJECT TO CHANGE WITHOUT NOTICE. PLEASE VISIT WWW.ECCOTEMP.COM/SUPPORT FOR MORE INFORMATION.



45-HI Replacement Parts

For models using natural or LP gas.

Instructions for placing a parts order

Address parts orders to the distributor or store from where the water heater was purchased.

All parts orders should include:

- The model and serial number of the water heater from the rating plate.
- Specify type of gas (natural or LP) as marked on the rating plate.
- Part description (as noted below) and number of parts desired.

⚠ WARNING: For your safety, DO NOT attempt to disassemble this unit for any reason

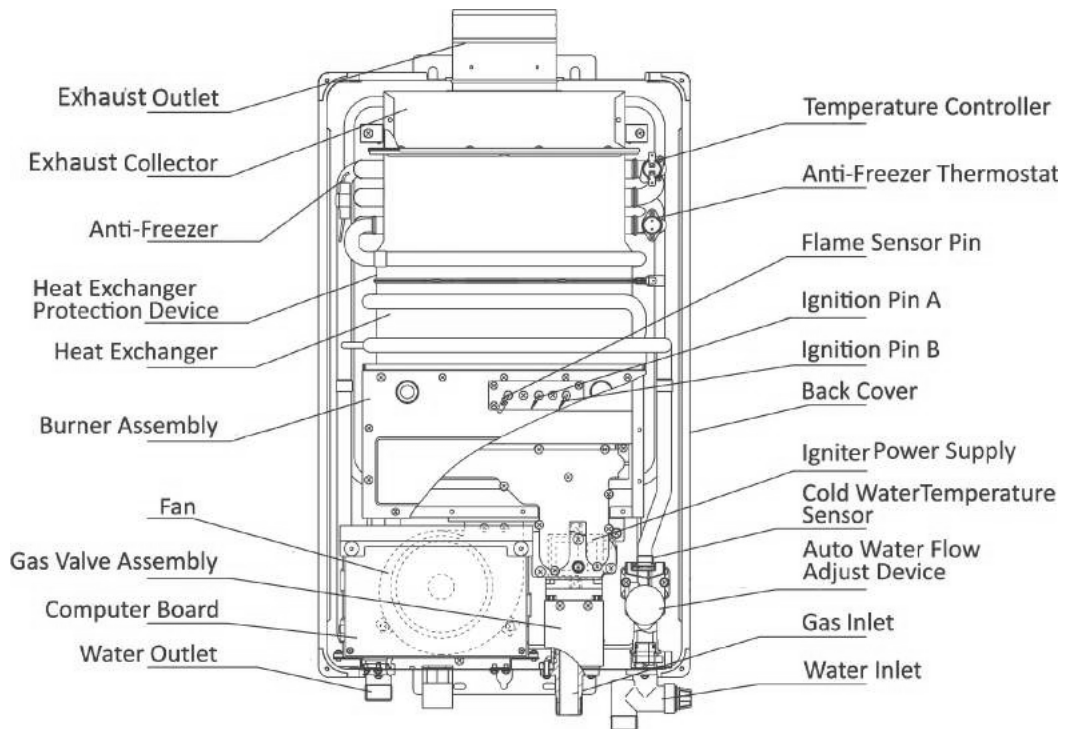

Notice: The Anti-Freezer and it's thermostat are for the outdoor unit and the indoor unit which has the Anti-Freezing function only.

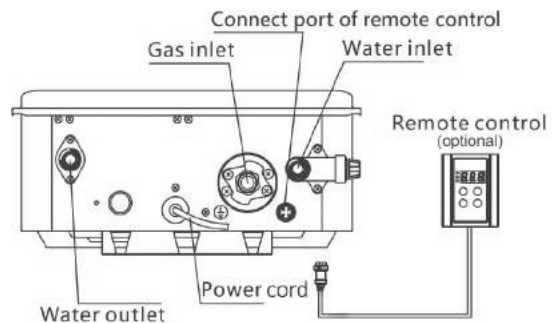
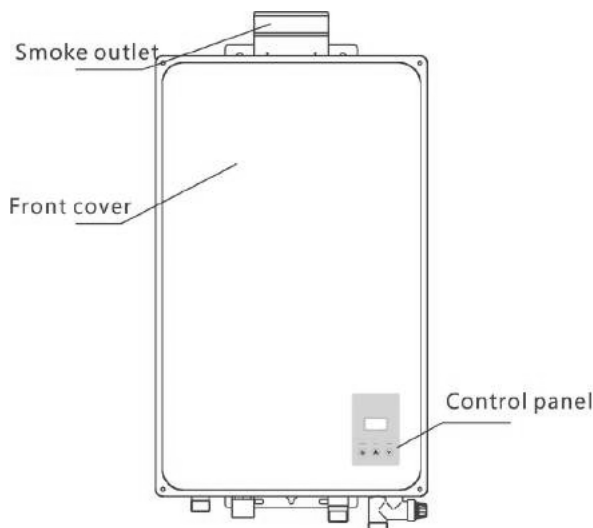

⚠ CAUTION: For your safety, DO NOT attempt repair of electrical wiring, gas piping, burners, or other safety devices. Refer repairs to qualified service personnel.

PLEASE NOTE: 45H IS FOR OUTDOOR PERMANENT INSTALLATIONS ONLY AND 45HI IS FOR INDOOR PERMANENT INSTALLATIONS ONLY. THIS MANUAL AND ALL ECCOTEMP CONTACT IS SUBJECT TO CHANGE WITHOUT NOTICE. PLEASE VISIT WWW.ECCOTEMP.COM/SUPPORT FOR MORE INFORMATION.



Eccotemp Systems ,LLC

Limited Warranty Information

Model (s) 45HI-LP, 45HI-NG, 45H-LP, 45H-NG

Eccotemp hereby warrants this product to be free of material defects in materials and workmanship when installed and operated according to Eccotemp's installation and operating instructions. This Limited Warranty extends to the original purchaser and subsequent owners, but only while the product remains as the site of the original installation. This Limited Warranty terminates if moved or reinstalled at a new location. There are no warranties, express or implied made or given other than contained in this Limited Warranty. No agent, employee or representative of Eccotemp has any authority to bind Eccotemp to any representation or warranty concerning the Product not contained in this Limited Warranty. Eccotemp reserves the right and authority to change, modify or alter this warranty at any given time.

Except as expressly set forth herein, THERE ARE NO REPRESENTATIONS OR WARRANTIES, EXPRESS OR IMPLIED, INCLUDING, WITHOUT LIMITATION, AS TO MERCHANTABILITY OR FITNESS FOR A PARTICULAR PURPOSE WITH RESPECT TO ANY GOODS SOLD HEREUNDER. BUYER'S EXCLUSIVE REMEDY IS LIMITED TO REPAIR OR REPLACEMENT OF THE GOODS SOLD, AT ECCOTEMP'S DISCRETION. ECCOTEMP SHALL NOT BE LIABLE FOR INCIDENTAL OR CONSEQUENTIAL DAMAGES.

Limited Warranty Period

This Warranty is extended by Eccotemp Systems to the Owner. This warranty takes effect on the date of installation of the Product or 30 days after the date of purchase, whichever occurs first, and is effective until the specified anniversary of such date as follows:

- 1) Limited Five-Year replacement (years 1 through 5) of defective parts other than the heat exchanger- Labor not included.
- 2) Limited additional Ten-Year replacement (years 1 through 10) on the heat exchanger when the Product is used in a single-family dwelling – Labor not included.
- 3) Limited additional Two-Year replacement (years 1 through 2) on the heat exchanger when the Product is used for commercial capacity, if it is used in other than a single family dwelling, or if the Product is supplied with pre-heated or circulated water – labor not included.

1. Total Ten-Year (Years 1 through 10) or 6,500 operational (burn) hours recorded by the water heater, whichever occurs first.

Item Period of Coverage

Heat Exchanger 10 years
All other parts 5 years

Coverage's are void if the unit is used in a hot water circulation loop, in series with a circulation system or where an on-demand recirculation system is not incorporated.

Owner is responsible for all other costs incidental to repair such as labor, shipping, delivery and permits. Proof of purchase required. Products repaired will be covered under this Limited Warranty for the remainder of term of the original purchase.

Shipping Related Costs:

Within the first 30 days of purchase, Eccotemp will cover all ground shipping costs for warranty related issues, excluding AK, HI, Canada, and any location outside of the continental US. After the first 30 days of purchase, Eccotemp will cover all ground non expedited shipping costs to the customer for warranty related issues, excluding AK, HI, Canada, and any location outside of the continental US. After the first 30 days of purchase, the customer is responsible for all shipping to Eccotemp, regardless of reason or circumstance. The method for warranty related shipping will be Ground equivalent with the provider of Eccotemp's choosing.

AK, HI, Canada, and any location outside of the continental US, will be responsible for all shipping costs, regardless of reason or circumstance.

All shipments of any type of product coming to Eccotemp for any reason must have an RGA for any repairs to be made. Please contact Eccotemp to obtain an RGA number prior to shipping anything to Eccotemp. Failure to do so could result in loss of product. Eccotemp will not be responsible for replacement due to loss or damage if these steps are not properly followed.

PLEASE NOTE: 45H IS FOR OUTDOOR PERMANENT INSTALLATIONS ONLY AND 45HI IS FOR INDOOR PERMANENT INSTALLATIONS ONLY. THIS MANUAL AND ALL ECCOTEMP CONTACT IS SUBJECT TO CHANGE WITHOUT NOTICE. PLEASE VISIT WWW.ECCOTEMP.COM/SUPPORT FOR MORE INFORMATION.



Exclusions

Please refer to the Installation Manual and Use & Care Manual supplied with your new Eccotemp Systems product. This Limited Warranty becomes null and void if any of the following are determined to be a contributing factor by Eccotemp to the failure of the product:

1. Abuse, misuse, alteration, neglect or misapplication.
2. Improper, dangerous, destructive maintenance procedures or inadequate maintenance.
3. Damages caused by services performed by servicers other than Eccotemp Systems.
4. Installation in a corrosive or otherwise destructive environment.
5. Damage as a result of freezing within the unit or surrounding piping.
6. Scale buildup.
7. Incorrect gas or water pressure.
8. Acts of force Majeure.
9. Damage as a result of use with non-portable, untreated or poorly treated well water, or water with high PH levels or hardness levels in excess of 12 grains per gallon (200mg/L).
10. Incorrect sizing for the application.
11. Products with original serial numbers that have been removed or altered and cannot be readily determined.
12. Acts of God including, but not limited to; fire, flood, or nature disaster.

This Product is not to be used as a pool or spa heater.

In the event of an Eccotemp Systems recognized defect, malfunction, or failure to conform to this Warranty and based upon Eccotemp approval of warranty claim, Eccotemp Systems, at its sole and absolute discretion, will settle the warrant claim of such defect, malfunction, or failure to conform to this Warranty. In order to make a claim under this Warranty, The Owner must notify Eccotemp of the failure of the Product to conform to this Warranty.

Under this Warranty, Eccotemp Systems will only provide replacement parts as described in the "Limited Warranty Period". The Owner will be responsible for any cost incurred including labor costs for servicing the unit, shipping, delivery, and handling of the replacement part, cost for permits or materials necessary for the repair, or incidental costs resulting from damage external to the unit resulting from the failure.

NOTWITHSTANDING ANYTHING IN THIS WARRANTY TO THE CONTRARY, EXCEPT FOR ECCOTEMP SYSTEMS' AFFIRMATIVE OBLIGATIONS EXPRESSLY SET FORTH IN THIS WARRANTY, ECCOTEMP SYSTEMS DISCLAIMS ANY AND ALL WARRANTIES, EITHER EXPRESS OR IMPLIED, REGARDING THE PRODUCT AND ITS FUNCTIONALITY, PERFORMANCE, MERCHANTABILITY, FITNESS FOR PARTICULAR PURPOSE OR INTELLECTUAL PROPERTY RIGHTS. ECCOTEMP SYSTEMS DISCLAIMS ALL OTHER OBLIGATIONS OR LIABILITIES ON ITS PART AND NEITHER ASSUMES NOR AUTHORIZES ANY OTHER PERSON TO ASSUME FOR ECCOTEMP SYSTEMS AN OTHER LIABILITIES IN CONNECTION WITH THE PERFORMANCE OF THE PRODUCT. THIS WARRANTY ONLY COVERS REPLACEMENT PARTS AND DOES NOT COVER COST OF LABOR OR SERVICES UNDER ANY CIRCUMSTANCES.

This warranty only applies to the 50 states of the U.S.A and Territories of Canada. Eccotemp Systems shall not be liable for any claim or demand against Eccotemp Systems by any other part for damages of any kind, including, but not limited to incidental and consequential damages, arising out of the subject matter of this Agreement. Some States do not allow exclusion or limitation of incidental or consequential damages, so the above limitation or exclusion may not apply to you. This warranty gives you specific legal rights. You may also have other rights that vary from State to State.

PLEASE NOTE: 45H IS FOR OUTDOOR PERMANENT INSTALLATIONS ONLY AND 45HI IS FOR INDOOR PERMANENT INSTALLATIONS ONLY. THIS MANUAL AND ALL ECCOTEMP CONTACT IS SUBJECT TO CHANGE WITHOUT NOTICE. PLEASE VISIT WWW.ECCOTEMP.COM/SUPPORT FOR MORE INFORMATION.





ECCOTEMP
THE FUTURE OF EFFICIENCY

PHONE: 866-356-1992 | EMAIL: SUPPORT@ECCOTEMP.COM | ADDRESS: 315 - A INDUSTRIAL RD SUMMERVILLE, SC 29483

 **SUPPORT:** [ECCOTEMP.COM/HELP-DESK](https://www.eccotemp.com/help-desk)  **SHOP ONLINE:** [ECCOTEMP.COM/PRODUCT](https://www.eccotemp.com/product)  **STORE LOCATOR:** [ECCOTEMP.COM/LOCATOR](https://www.eccotemp.com/locator)

[ECCOTEMP.COM](https://www.eccotemp.com)

