

Safety Information

Important Safety Information

This owner's guide includes information for Regulatory Model(s): RVD-Y1

SAVE THESE INSTRUCTIONS

 **WARNING:** When using an electrical appliance, basic precautions should always be followed, including the following:

READ ALL INSTRUCTIONS

 **WARNING:** To reduce the risk of injury or damage, read and follow the safety precautions when setting up, using and maintaining your robot.

This appliance can be used by children aged from 8 years and above and persons with reduced physical, sensory or mental capabilities or lack of experience and knowledge if they have been given supervision or instruction concerning use of the appliance in a safe way and understand the hazards involved. Children shall not play with the appliance. Cleaning and user maintenance shall not be made by children without supervision.

 This is the safety alert symbol. It is used to alert you to potential physical injury hazards. Obey all safety messages that follow this symbol to avoid possible injury or death.

 Risk of electric shock

 Class II equipment

 Rated power output, d.c.

 Read operator's manual

 General symbol for recycling

 Risk of fire

 For indoor use only

 Rated power input, d.c.

 Keep out of reach of children

 Separate Supply Unit

 Rated power input, a.c.

WARNING: Indicates a hazardous situation that, if not avoided, could result in death or serious injury.

CAUTION: Indicates a hazardous situation that, if not avoided, could result in minor or moderate injury.

NOTICE: Indicates a hazardous situation that, if not avoided, could result in property damage.

GENERAL



WARNING

- Your robot is not a toy. Small children and pets should be supervised when your robot is operating.
- Do not sit or stand on your robot or Home Base™.
- Do not use unauthorized chargers. Use of an unauthorized charger could cause the battery to generate heat, smoke, catch fire, or explode.
- Your robot comes with a region approved power supply cord and is designed to be plugged into a standard household AC power outlet only. Do not use any other power supply cord. For replacement cords, please contact Customer Care to ensure proper selection of country specific power supply cord.
- Do not open your robot or Home Base™. There are no user serviceable parts inside. Refer servicing to qualified service personnel.
- Risk of electric shock, use indoors in dry location only.
- Do not handle your robot or Home Base™ with wet hands.
- Store and operate your robot in room temperature environments only.
- If the room to be cleaned contains a balcony, a physical barrier should be used to prevent access to the balcony and ensure safe operation.
- Clean cliff sensors for buildup.



CAUTION

- Do not operate the robot in areas with exposed electrical outlets in the floor.
- If the device passes over a power cord and drags it, there is a chance an object could be pulled off a table or shelf. Before using this device, pick up objects like clothing, loose papers, pull cords for blinds or curtains, power cords, and any fragile objects.
- Be aware that the robot moves on its own. Take care when walking in the area that the robot is operating in to avoid stepping on it.
- Do not use this device to pick up sharp objects, glass, or anything that is burning or smoking.

NOTICE

- This robot is intended for dry floor use only. Do not use this device to pick up spills. Do not allow your robot or Home Base™ to become wet.
- Do not place anything on top of your robot.
- The failure to maintain cleanliness of charger contacts could result in loss of ability for the robot to charge the battery.

HOME BASE



WARNING

- Do not use a Home Base™ with a damaged cord or plug if the cord or plug is damaged, it must be replaced.
- Always disconnect your robot from the Home Base™ before cleaning or maintaining it.

- Charge your robot only with the power supply provided. The provided power supply delivers safety extra low voltage corresponding to the input marking on the robot which is required to maintain safe operation.
- To prevent the risk of your robot falling downstairs, ensure that the Home Base™ is placed at least 4 feet (1.2 meters) away from stairs.

NOTICE

- Product may not be used with any type of power converter. Use of power converters will immediately void the warranty.
- If you live in an area prone to electrical storms, it is recommended that you use additional surge protection. Your Home Base™ may be protected with a surge protector in the event of severe electrical storms.

BATTERY



WARNING



- Do not open, crush, heat above 176°F: 80°C, or incinerate. Follow manufacturer's instructions.
- Do not short-circuit the battery by allowing metal objects to contact battery terminals or immerse in liquid. Do not subject batteries to mechanical shock.
- Periodically inspect the battery pack for any sign of damage or leakage. Do not charge damaged or leaking battery packs, do not allow the liquid to come in contact with skin or eyes. If contact has been made, wash the affected area with copious amounts of water and seek medical advice. Place the battery in a sealed plastic bag and recycle or dispose of safely

according to local environmental regulations, or return it to your local authorized iRobot Service Center for disposal.

- Lithium ion batteries and products that contain lithium ion batteries are subject to stringent transportation regulations. If you need to ship this product (with the battery included) for service, travel or any other reason, you MUST see the Troubleshooting section of your manual or contact customer care for shipping instructions.



CAUTION



- Battery usage by children should be supervised. Seek medical advice immediately if a cell or a battery has been swallowed.

NOTICE

- The battery pack must be removed from the robot before recycling or disposal.
- For best results, only use the iRobot Lithium Ion Battery that comes with the robot.
- Do not use non-rechargeable batteries. Use only the rechargeable battery supplied with the product. For replacement, purchase identical iRobot battery or contact iRobot Customer Care for alternative battery options.
- Always charge and remove the battery from your robot and accessories before long-term storage.

For battery recycling go to call2recycle.org; or call 1-800-822-8837



About your Roomba® Robot Vacuum

Top View

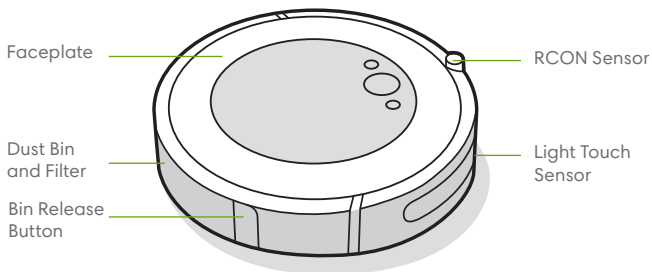

Bottom View

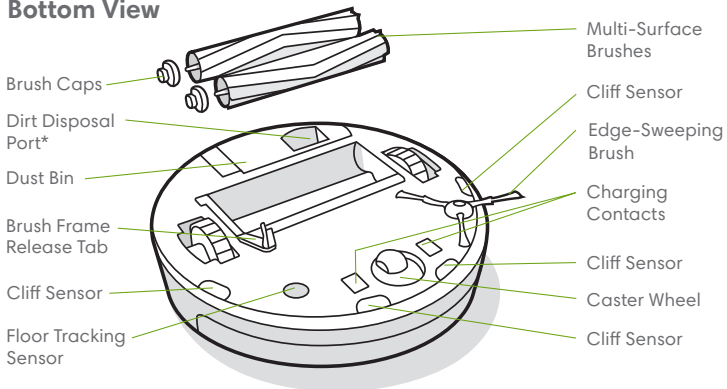

*Select models only

Home Base™ Charging Station

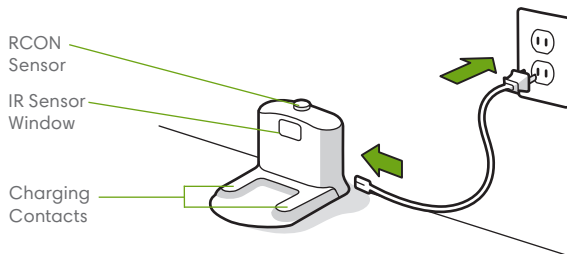

Buttons & Indicators

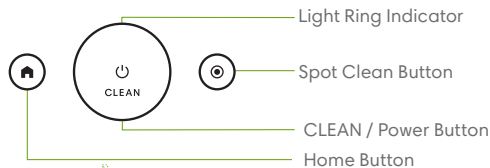

Using Your Roomba® Robot Vacuum

Positioning the Home Base™ Charging Station

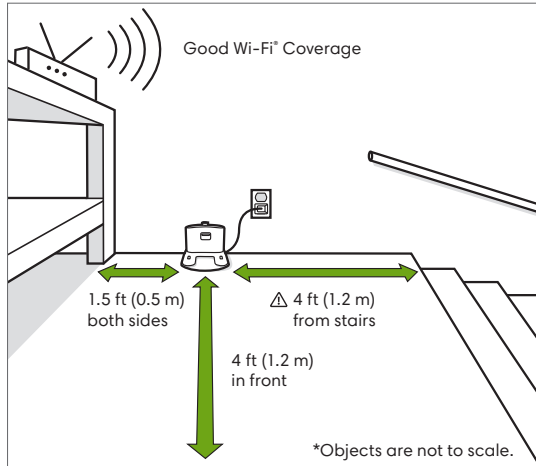

⚠ WARNING: To prevent the risk of your robot falling downstairs when it is leaving from or returning to the Home Base™, ensure that the Home Base™ is placed at least 4 feet (1.2 meters) away from stairs.

Download the iRobot HOME App and connect to Wi-Fi®

- Follow step-by-step instructions to set up your Roomba.
- Set an automatic cleaning schedule and customize cleaning preferences.
- Access to tips, tricks, and answers to commonly asked questions.



Charging



- **White Light Ring While Charging**
 - Solid White: fully charged
 - Pulsing White: charging
 - Pulsing Red: charging/low
 - Turns off after 1 minute to save power

- Place the robot on the Home Base™ to activate the battery.
 - **Note:** Your robot comes with a partial charge, but we recommend that you charge the robot for 3 hours prior to starting the first cleaning job.
- If your robot needs to recharge mid-cleaning, it will return to its Home Base™. Once it is sufficiently charged, it will then resume the cleaning job where it left off.
- The robot uses a small amount of power whenever it is on the Home Base™. You can put the robot in a further-reduced power state when not in use. For instructions and more details on this Reduced Power Standby Mode, refer to the iRobot HOME App.
- For long-term storage, turn off the robot by removing it from the Home Base™ and holding down  for 10 seconds. Store the robot in a cool, dry place.

Cleaning



Remove excess clutter from floors before cleaning. Use your robot frequently to maintain well-conditioned floors.

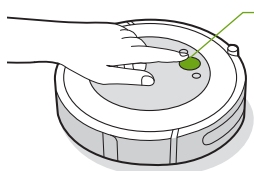

Just Press CLEAN

Tap to Start / Pause / Resume

Hold for 3 seconds to end a job

- Your robot will automatically explore and clean your home. It will return to the Home Base™ at the end of a cleaning job and whenever it needs to recharge.
- To send the robot back to its Home Base™, tap . A blue light ring pattern will indicate that the robot is seeking the Home Base™.
- When your robot detects an especially dirty area, it will go into Dirt Detect™ mode, moving over the area multiple times until it senses that the area has been sufficiently cleaned. The light ring indicator will flash blue.
- Tap to spot clean a designated area. The robot will spiral outward about 3 feet (1 meter) and then spiral inward to end where it started. The light ring indicator will show a blue spiral.



When the robot senses its bin needs to be emptied, the light ring indicator will illuminate in a red sweeping motion toward the rear.

Troubleshooting

- Your robot will tell you something is wrong by playing an audio alert and turning the light ring indicator red. Press CLEAN for details. Further support and instructional videos are available in the iRobot HOME App.

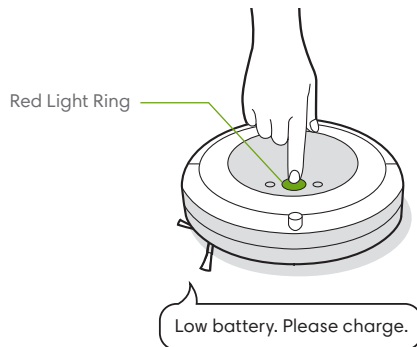

- If you are unsure if the robot is finished or paused, consult the iRobot HOME App to check on its status.

Battery Safety & Shipping

For best results, only use the iRobot Lithium Ion Battery that comes with your robot.

⚠ WARNING: Lithium ion batteries and products that contain lithium ion batteries are subject to stringent transportation regulations. If you need to ship this product for service, travel or any other reason, you **MUST** follow the below shipping instructions.

- Battery **MUST** be turned off before shipping.
- Turn off the battery by removing the robot from the Home Base™ and holding down for 10 seconds. All indicators will turn off.
- Package the robot securely for shipping.
- If you need further assistance, contact our Customer Care team or visit global.irobot.com.

Accessories

Dual Mode Virtual Wall® Barrier*

 **Note:** For best results, place at least 8 feet (2.5 meters) from the Home Base™.

Use the Dual Mode Virtual Wall® barrier to keep the robot in the places you want cleaned — and out of the ones you don't. It creates an invisible barrier that only the robot can see. You can leave the device in position between cleanings.

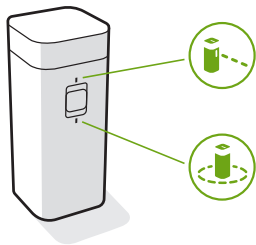

*Dual Mode Virtual Wall included for select models only

Choose the mode to meet your needs:

Virtual Wall Mode: When the switch is in the Virtual Wall position () , the device will create a linear barrier to block openings up to 10 feet (3 meters).

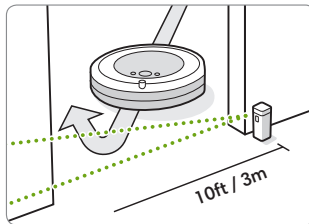

 **Note:** This barrier gets wider as it gets further from the device (refer to illustration).

Halo Mode: Toggle the switch to the Halo position () , to create a circular barrier. This will prevent the robot from approaching zones you want to protect such as a pet bowl, vase, or under a desk. The Halo barrier extends approximately 24 inches (60 centimeters) from the center of the device.

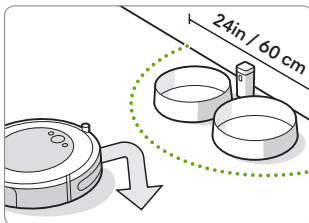

 **Note:** The batteries will last about 8-10 months under normal use. If you are not planning to use your Virtual Wall barrier for an extended period of time, be sure to turn the switch to the Off, or middle position.

Care and Maintenance

Care and Maintenance Instructions

To keep your robot running at peak performance, perform the procedures on the following pages.

There are additional instructional videos in the iRobot HOME App. If you notice the robot picking up less debris from your floor, empty the bin, clean the brushes, and clean or replace the filter if needed.

Part	Care Frequency	Replacement Frequency*
Bin	Wash bin as needed	
Filter	Clean once a week (twice a week if you have a pet). Do not wash.	Every 2 months
Full Bin Sensor	Clean every 2 weeks	
Front Caster Wheel	Clean every 2 weeks	Every 12 months
Edge-Sweeping Brush and Multi-Surface Brushes	Clean once a month (twice a month if you have a pet)	Every 12 months
Sensors and Charging Contacts	Clean once a month	

Note: iRobot manufactures various replacement parts and assemblies. If you think you need a replacement part, please contact iRobot Customer Care for more information.

*Replacement frequency may vary. Parts should be replaced if visible wear appears.

Emptying the Bin

- 1 Press bin release button to remove bin.



- 2 Open bin door to empty bin.

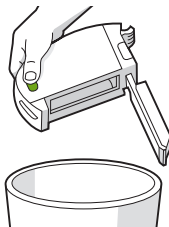

- 3 Place bin back in the robot.

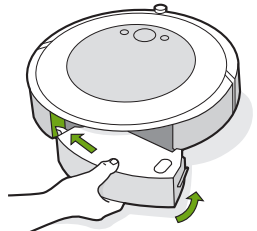

Cleaning the Filter

- 1 Remove the bin. Remove the filter by grasping both ends and pulling out.

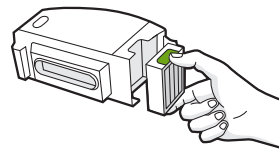

- 2 Remove debris by tapping the filter against your trash container.



- 3 Reinsert filter with ridged grips facing out. Place bin back in the robot.

*** Important:** The robot will not run if the filter is not installed correctly. Replace the filter every two months.

Cleaning the Full Bin Sensors

- 1 Remove and empty the bin.

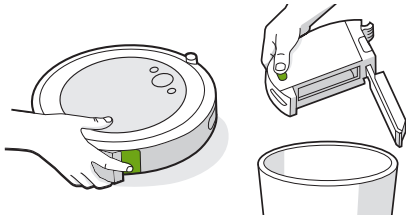

- 2 Wipe the inner sensors with a clean, dry cloth

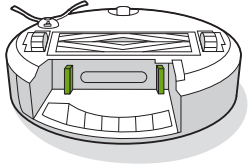

- 3 Wipe the bin door with a clean, dry cloth.

Closed Door



Opened Door

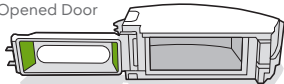

Washing the Bin

-  **Important:** Do not wash the filter. Remove the filter before washing the bin.

- 1 Release the bin, remove the filter, and open the bin door.
- 2 Rinse the bin using warm water.

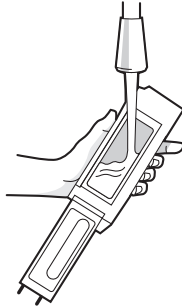

-  **Note:** Bin is not dishwasher safe.

- 3 Make sure bin is completely dry. Reinsert filter and place bin back in the robot.

Cleaning the Edge-Sweeping Brush

- 1 Use a small screwdriver to loosen the screw holding the Edge-Sweeping Brush in place.
- 2 Pull to remove the Edge-Sweeping Brush. Remove any hair or debris, then reinstall the brush.

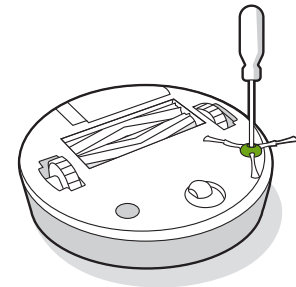

Cleaning the Front Caster Wheel

- 1 Pull firmly on the front wheel module to remove it from the robot.
- 2 Pull firmly on the wheel to remove it from its housing (see illustration below).
- 3 Remove any debris from inside the wheel cavity.
- 4 Reinstall all parts when finished. Make sure the wheel clicks back into place.

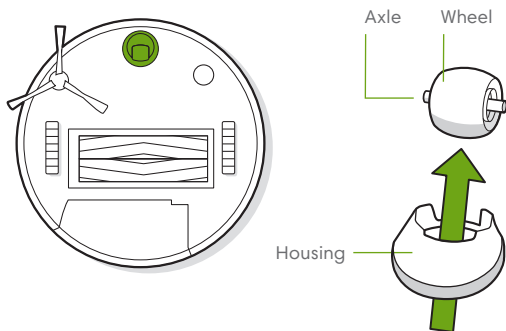

*** Important:** A front wheel clogged with hair and debris could result in damage to your floor. If the wheel is not spinning freely after you have cleaned it, please contact Customer Care.

Cleaning the Multi-Surface Brushes

- 1 Pinch the brush frame release tab, lift the tab, and remove any obstructions.
- 2 Remove the brushes from the robot. Remove the brush caps from the ends of the brushes. Remove any hair or debris that has collected beneath the caps. Reinstall the brush caps.
- 3 Remove any hair or debris from the square and hexagonal pegs on the opposite side of the brushes.
- 4 Remove the bin from the robot and clear any debris from the vacuum path.

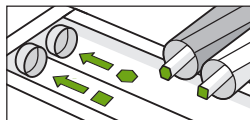
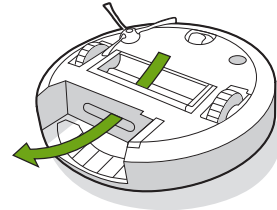
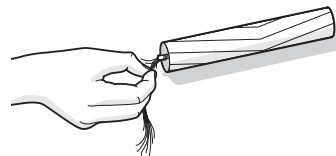
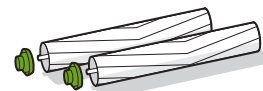
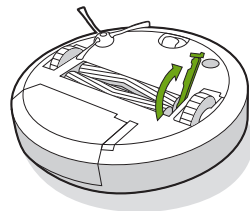

- 5 Reinstall the brushes in the robot. Match the shape of the brush pegs with the shape of the brush icons in the cleaning head module.

Cleaning the Sensors and Charging Contacts

- 1 Wipe, sensors and charging contacts with a clean dry cloth. You can alternatively use a pad of melamine foam to remove built up debris on the robot and Home Base charging contacts.

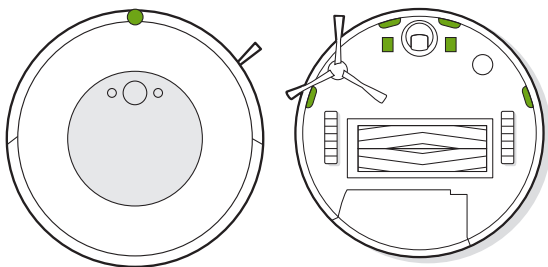

Important: Do not spray cleaning solution or water onto the sensors or sensor openings.



iRobot Customer Care

USA & Canada

If you have questions or comments about your Roomba® robot vacuum, please contact iRobot before contacting a retailer.

You can start by visiting global.irobot.com for support tips, frequently asked questions and information about accessories. This information can also be found in the iRobot HOME App. If you need further assistance, call our Customer Care team at **(877) 855-8593**.

iRobot USA Customer Care Hours

- Monday to Friday, 9AM – 9PM Eastern Time
- Saturday and Sunday 9AM – 6PM Eastern Time

Outside USA & Canada

Visit global.irobot.com to:

- Learn more about iRobot in your country
- Get hints and tips to improve your Roomba® robot vacuum's performance
- Get answers to questions
- Contact your local support center

Regulatory Information

This device complies with part 15 of the FCC Rules.

Operation is subject to the following two conditions: (1) This device may not cause harmful interference, and (2) this device must accept any interference received, including interference that may cause undesired operation.

This device contains a licence-exempt transmitter/receiver that complies with Innovation, Science and Economic Development (ISED) Canada's licence-exempt RSS(s). Operation is subject to the following two conditions: 1) This device may not cause interference, and 2) this device must accept any interference, including interference that may cause undesired operation of the device.

- Changes or modifications not expressly approved by iRobot Corporation could void the user's authority to operate the equipment.
- This equipment has been tested and found to comply with the limits for a Class B digital device, pursuant to part 15 of the FCC Rules. These limits are designed to provide reasonable protection against harmful interference in a residential installation. This equipment generates, uses and can radiate radio frequency energy and, if not installed and used in accordance with the instructions, may cause harmful interference to radio communications. However, there is no guarantee that interference to radio communication will not occur in a particular installation. If this equipment does cause harmful interference to radio or television reception, which can be determined by turning the equipment off and on, the user is encouraged to try to correct the interference by one or more of the following measures:

- Reorient or relocate the receiving antenna.
- Increase the separation between the equipment and receiver.
- Connect the equipment into an outlet on a circuit different from that to which the receiver is connected.
- Consult the dealer or an experienced radio/TV technician for help.
- Under Industry Canada regulations, this radio transmitter may only operate using an antenna of a type and maximum (or lesser) gain approved for the transmitter by Industry Canada. To reduce potential radio interference to other users, the antenna type and its gain should be so chosen that the equivalent isotropically radiated power (e.i.r.p.) is not more than the necessary for successful communication.
- FCC Radiation Exposure Statement: This product complies with FCC §2.1091(b) for mobile device RF exposure limits, set forth for an uncontrolled environment and is safe for the intended operation as described in this manual. Per FCC requirements, maintain a distance of more than 8 inches (20cm) between any person and the host device (Roomba robot).
- ISED Radiation Exposure Statement: This product complies with the Canadian Standard RSS-102 for portable RF exposure limits, set forth for an uncontrolled environment and is safe for the intended operation as described in this manual. Per ISED requirements, maintain a distance of more than 8 inches (20 cm) between any person and the robot.



iRobot

©2020 iRobot Corporation, 8 Crosby Drive, Bedford, MA 01730 USA. All rights reserved iRobot, Roomba, iAdapt and Virtual Wall are registered trademarks of iRobot Corporation. Home Base and Dirt Detect are trademarks of iRobot Corporation. Wi-Fi and the Wi-Fi logo are registered trademarks of Wi-Fi Alliance.

For battery recycling go to call2recycle.org;
or call 1-800-822-8837

