

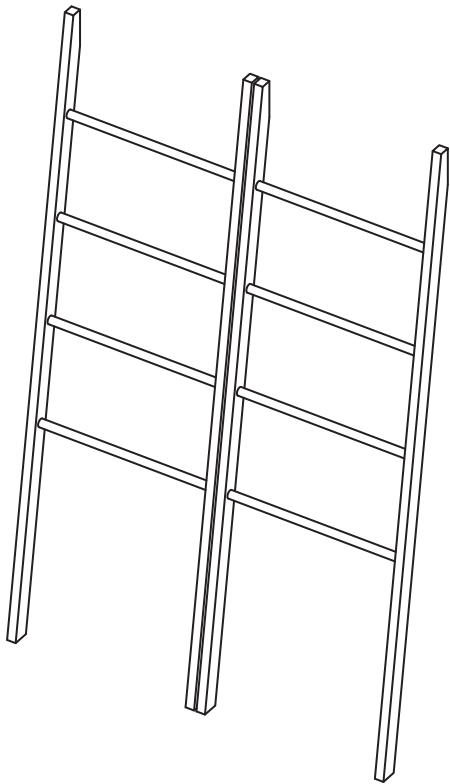



Assembly Instruction

Item#117-2X

Decorative Twin Ladders



Anti-Tipping Hardware

NO	DESCRIPTION	Q'TY
RF10004	 Screws F6 x 5/8"	4
RF10002	 Screws F6 x 1 1/4"	2
RF50003	 L-Bracket	2

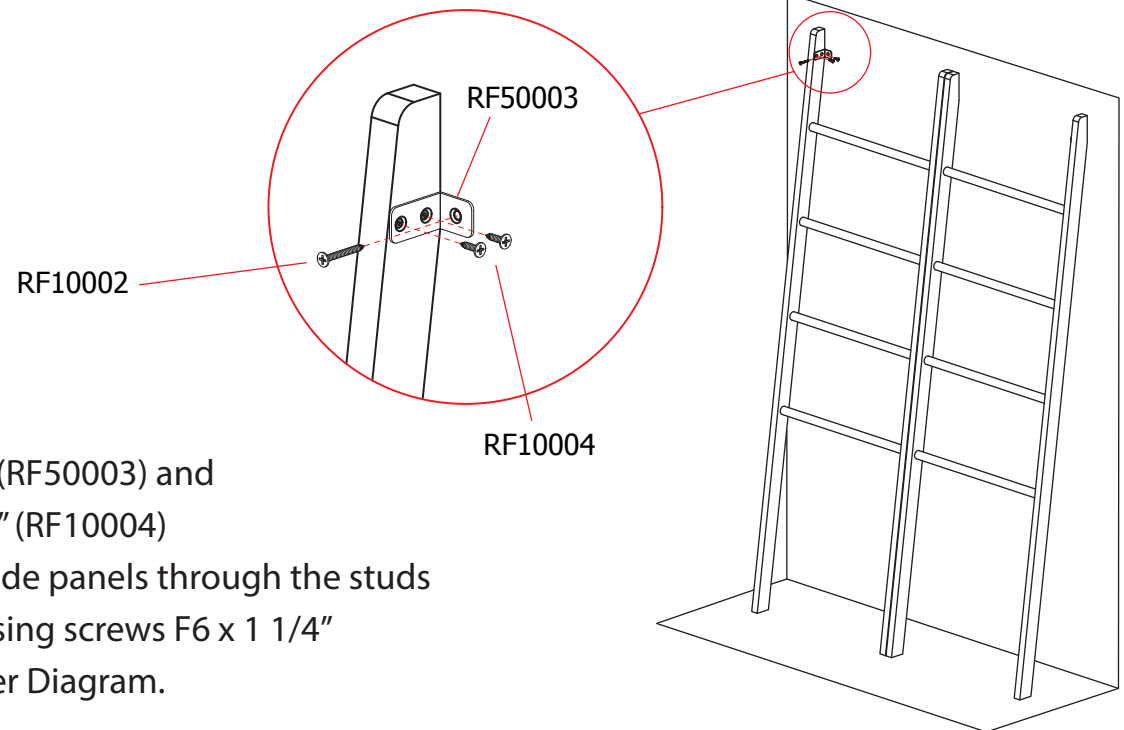
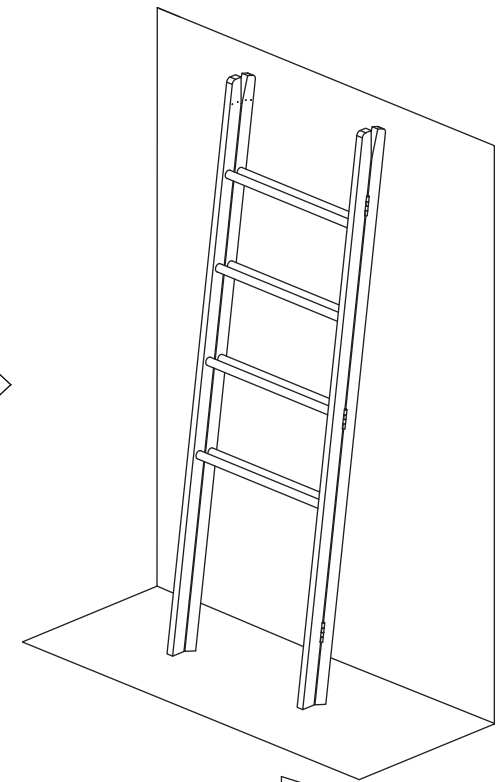
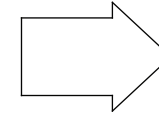
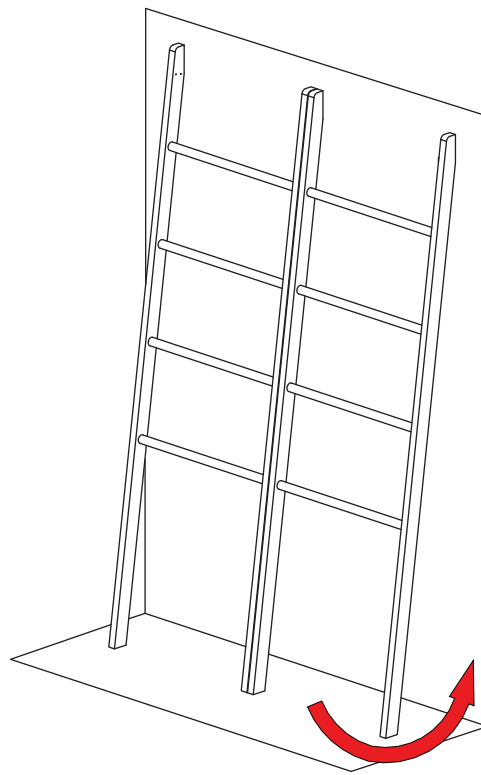

Anti-Tipping

Use L-brackets (RF50003) and screws F6 x 5/8" (RF10004) to attach two side panels through the studs into the wall, using screws F6 x 1 1/4" (RF10002) as per Diagram.