



# DOUBLE WALL OVEN



Installation Guide and User Manual

## ATTAINABLE LUXURY<sup>®</sup>

Luxury should never be left desired - it's meant to be attainable."  
- Andrew Zuro, Founder

## Registering Your Product



Please register your ZLINE appliance to activate your warranty. Begin the simple registration process by scanning the QR code.

By registering your appliance, you will have access to:

- Technical Support
- Warranty Service
- Tracking your support inquiries

**⚠ WARNING:** This product can expose you to chemicals including nickel, which is known to the State of California to cause cancer. For more information, go to [www.P65Warnings.ca.gov](http://www.P65Warnings.ca.gov).

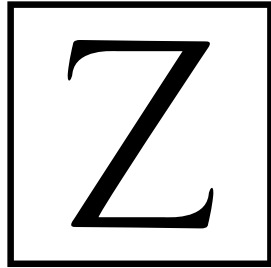

ZLINE

Ignite your kitchen experience with the ZLINE Wall Oven. Integrated with the high-performance you expect from ZLINE Ranges, ZLINE Wall Ovens combine the speed of a microwave and the power of an oven to make it an elite appliance. The built-in installation achieves a seamless, sleek aesthetic and a clutter-free kitchen.

ZLINE is fueled by a passion for innovation; A relentless pursuit of bringing the highest end luxury designs and professional features into everyone's homes. Because we continually strive to improve our products, we may change specifications and designs without prior notice.

# WARRANTY

## COVERAGE

ZLINE Kitchen and Bath range products will be warrantied for one year from the original purchase date for the original purchaser of the product. This warranty covers all parts for necessary repairs if any part of the product proves to be defective in materials or workmanship.

## TERMS

This warranty applies only to the original purchaser of a range product installed for normal residential use. This is defined as a single-family, residential dwelling in a non-commercial setting. Commercial settings include but are not limited to: schools, churches, hotels, restaurants, vacation rentals such as Airbnb, day care centers, private clubs, fire stations, common areas in multi-family dwellings, nursing homes, food service locations, and institutional food service locations such as hospitals or correction facilities. This warranty is non-transferable and will not be extended based on the date of installation. The warranty applies only to products installed in the continental United States and the District of Columbia.

Warranty shall not apply and ZLINE Kitchen and Bath is not responsible for damage resulting from negligence, improper maintenance, misuse, abuse, alteration of or tampering with the appliance, accident, natural disaster, improper electric supply, flare-up fires, unauthorized service or repair, improper installation, or installation not in accordance with the instructions contained in the manual, or the local codes.

## WHAT IS NOT COVERED

1. Installation or start-up, damages or problems caused by improper installation or use.
2. Service by an unauthorized service providers or damage related to unauthorized service or unauthorized parts.
3. Installation in any commercial or non-residential application.
4. Removal or re-installation cost.
5. Aesthetic damage, scratches, or natural wear caused by normal use.
6. Second-hand, open box products or products purchased from an unauthorized retailer.

# TABLE OF CONTENTS

|                               |    |
|-------------------------------|----|
| IMPORTANT SAFETY INSTRUCTIONS | 1  |
| PRODUCT SPECIFICATIONS        | 4  |
| PARTS AND TOOLS               | 5  |
| GROUNDING INSTRUCTIONS        | 6  |
| INSTALLATION                  | 8  |
| OPERATION                     | 17 |
| CLEANING AND MAINTENANCE      | 47 |
| TROUBLESHOOTING               | 55 |

# SAFETY INSTRUCTIONS



To reduce the risk of fire, electrical shock, injury to persons, or damage when using the oven, follow basic precautions, including the following:

## PROPER INSTALLATION

This appliance must be properly installed and electrically grounded by a qualified technician. Connect only to properly grounded outlet. See “Grounding Instructions” found in the Installation Instructions.

- This appliance should be serviced only by a qualified service technician. Contact the nearest authorized service center for examination, repair or adjustment.
- Do not repair or replace any part of the oven unless specifically recommended. Refer service to an authorized servicer.
- Do not operate this appliance if it is not working properly or if it has been damaged, until an authorized servicer has examined it.
- Install or locate this appliance only in accordance with the installation instructions.
- Use this oven only as intended by the manufacturer. If you have any questions, contact the manufacturer.
- Do not cover or block any openings on this appliance.
- Use this appliance only for its intended use as described in this manual. Do not use corrosive chemicals, vapors, or nonfood products in this appliance. This type of oven is specifically designed to heat or cook. It is not designed for industrial or laboratory use. The use of corrosive chemicals in heating or cleaning will damage the appliance.

## TO REDUCE THE RISK OF FIRE IN THE OVEN CAVITY

- Do not store flammable materials in or near the oven.
- Do not use water on a grease fire. Smother fire or use a dry chemical or foam-type extinguisher.
- It is highly recommended that a fire extinguisher be readily available and highly visible next to any cooking appliance.

# SAFETY INSTRUCTIONS

- Do not overcook food. Carefully attend oven if paper, plastic or other combustible materials are placed inside the oven.
- Do not use the cavity for storage purposes. Do not leave paper products, cooking utensils or food in the cavity when not being used.
- If materials inside the oven should ignite, keep oven door closed. Turn oven off and disconnect the circuit at the circuit breaker box.
- Be sure the blower fan runs whenever the oven is in operation. If the fan does not operate, do not use the oven. Call an authorized service center.
- Never use the oven to warm or heat a room.

## PERSONAL SAFETY

- Do not allow children to use this appliance unless closely supervised by an adult. Children and pets should not be left alone or unattended in the area where the appliance is in use. Never allow children to sit or stand on any part of the oven.
- For personal safety, wear proper clothing. Loose fitting or garments with hanging sleeves should never be worn while using this appliance.
- Tie long hair so that it doesn't hang loose.
- Do not touch heating elements or interior surfaces of oven.
- The heating elements may be hot even though they are dark in color. Interior surfaces of an oven become hot enough to cause burns.
- During and after use, do not touch or let clothing or other flammable materials contact the heating elements or the interior surfaces of the oven until they have had sufficient time to cool.
- The trim on the top and sides of the oven door may become hot enough to cause burns.
- Use care when opening the door. Open the door slightly to let hot air or steam escape before removing or replacing food.
- Do not heat unopened food containers. Build-up of pressure may cause the container to burst and cause injury.
- Always place oven racks in desired location while oven is cool. If a rack must be moved while oven is hot, do not let potholder contact the hot heating elements.
- Use only dry potholders. Moist or damp potholders on hot surfaces may result in burns from steam. Do not let potholder touch hot heating elements. Do not use a towel or other bulky cloth.

# SAFETY INSTRUCTIONS

## SAFETY FOR THE SELF-CLEANING OVEN

- Before self-cleaning the oven, remove the broiler pan, oven racks (only when not made of porcelain), other utensils and excess soft spillage.
- Confirm that the door locks and will not open once both selectors are in CLEAN position and the door lock icon appears. If the door does not lock, turn the cook mode selector to OFF and do not run Self-Clean. Call an authorized servicer.
- Do not clean the door gasket. It is essential for a good seal. Care should be taken not to rub, damage, move or remove the door gasket.
- Do not use commercial oven cleaners or oven liner protective coatings of any kind in or around any part of the oven.
- Clean only oven parts listed in this manual.
- Other surfaces of the appliance may become hot enough to cause burns - among these surfaces are for example: oven vent openings and surfaces near these openings, oven doors, and windows of oven doors.

SAVE AND READ THESE INSTRUCTIONS.



# BEFORE INSTALLATION

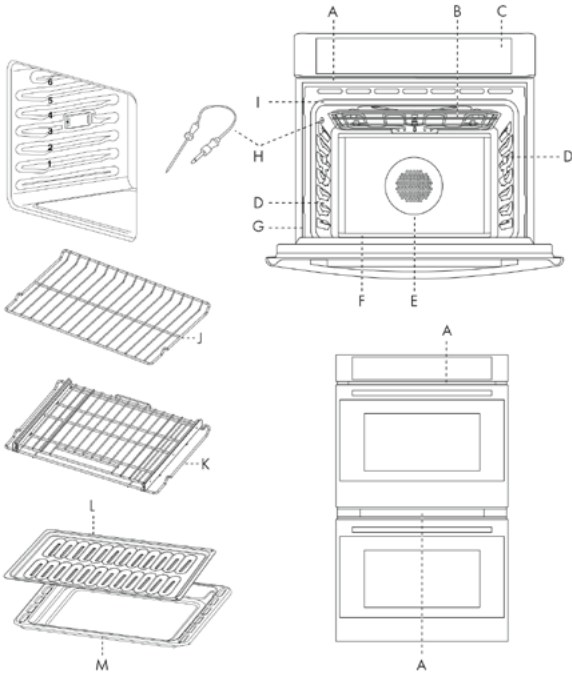

- A. Cooling Vents
- B. Broil Element
- C. Control Panel
- D. Halogen Light
- E. Convection
- F. Bottom Element (not visible)
- G. Appliance Tag
- H. Temperature Probe (Upper Oven Only)
- I. Door Gasket
- J. Oven Rack (2)
- K. Telescoping Oven Rack (1)
- L. Broiler Pan
- M. Broiler Pan Tray

| OVEN                 | DIMENSION   | ELECTRICAL RATING AND MAXIMUM CONNECTED LOAD AT 240 VOLTS 60 HZ |            |
|----------------------|-------------|---|------------|
| Double Built-In Oven | 30" (76 cm) | 35.4 Amp  | 8500 Watts |

| LETTER | DOUBLE OVEN DIMENSIONS                |
|--------|---------------------------------------|
| A      | 51 3/16" (130.0 cm) Height (overall)  |
| B      | 28 1/2" (72.4 cm) Width (recessed)    |
| C      | 49 15/16 (126.8 cm) Height (recessed) |
| D*     | 23 1/2" (59.7 cm) Depth (recessed)    |
| E      | 29 7/8" (75.9 cm) Width (overall)     |

\*From back of unit to cabinet face.

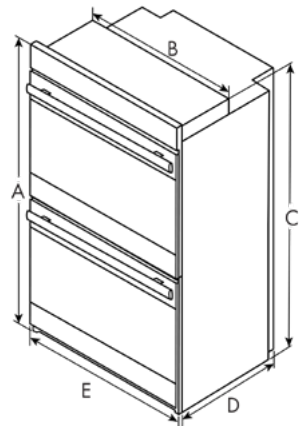

# BEFORE INSTALLATION

Gather the required tools before starting installation. Read and follow the instructions provided with any tools listed here.

## TOOLS NEEDED

- Measuring Tape
- Straightedge
- Pencil
- Phillips Screwdriver
- Level
- Wire Cutters and Wire Stripper
- Hand or Sabre Saw
- 1" Hole Saw
- Cordless Drill and Drill Bit
- Safety Gloves and Goggles
- Volt Meter (0-250VAC)

## PARTS NEEDED

- UL Listed Conduit Connector
- UL Listed Wire Connectors

## PARTS PROVIDED

- #8-14 x 1" Screws - 4

# BEFORE INSTALLATION



## ELECTRIC SHOCK HAZARD

If codes permit and a separate ground wire is used, it is recommended that a qualified electrical installer determine that the ground path is adequate and wire gauge is in accordance with local codes. Do not use an extension cord.

## IN U.S.A.

Be sure that the electrical connection and wire size are adequate and in conformance with the National Electrical Code, ANSI/ NFPA No. 70-latest edition and all local codes and ordinances. A copy of the above code standards can be obtained from:

National Fire Protection Association  
One Batterymarch Park  
Quincy, MA 02269

## IN CANADA

Be sure that the electrical connection and wire size are adequate and in conformance with CSA standard C22.1, Canadian Electrical Code, Part 1 - latest edition, and all local codes and ordinances. A copy of the above code standards can be obtained from:

Canadian Standards Association  
178 Rexdale Blvd.  
Toronto, ON M9W 1R3 CANADA

- The electrical power to the oven branch circuit must be shut off while line connections are being made.
- Do not use an extension cord with this appliance.
- Electrical ground is required on this appliance. The free end of the green wire (the ground wire) must be connected to a suitable ground. This wire must remain grounded to the oven.
- If cold water pipe is interrupted by plastic, non metallic gaskets, union connections or other insulating materials, **DO NOT** use for grounding.

# BEFORE INSTALLATION

- **DO NOT** ground to a gas pipe.
- **DO NOT** have a fuse in the **NEUTRAL** or **GROUNDING** circuit. A fuse in the **NEUTRAL** or **GROUNDING** circuit could result in an electrical shock.
- Check with a qualified electrician if you are in doubt as to whether the appliance is properly grounded. Failure to do so could result in death, fire or electric shock.
- To properly install your oven, you must determine the type of electrical connection you will be using and follow the instructions provided for it here.
- Oven must be connected to the proper electrical voltage and frequency as specified on the model number rating plate. The model number rating plate is located under the control panel on the upper oven. All models are dual rated, and designed to be connected to 120/240V AC, 60Hz, 3-wire or 4-wire, singlephase power supply.
- Install a suitable conduit box (not furnished). An appropriately sized, UL conduit connector must be used to correctly attach the conduit to the junction box.
- **IMPORTANT:** Local Codes may vary; installation electrical connections and grounding must comply with all applicable local codes.
- If local codes permit grounding through the electrical supply neutral, connect both the white neutral wire and the green ground wire from the oven to the white neutral electrical supply wire.
- Check with a qualified electrical installer if you are not sure the oven is properly grounded.
- When a 4-wire, single phase 120/240 volt, 60 Hz., AC only electrical supply is available, a 40-amp maximum circuit protection is required.

| <b>VOLTAGE AND FREQUENCY</b> | <b>AMPS</b> | <b>CIRCUIT REQUIRED</b> |
|------------------------------|-------------|-------------------------|
| 240V, 60Hz                   | 35.4A       | 40 Amp Circuit          |

# BEFORE INSTALLATION



This appliance shall be installed only by authorized persons and in accordance with the manufacturer's installation instructions, local gas fitting regulations, municipal building codes, electrical wiring regulations, local water supply regulations.

Observe all governing codes and ordinances.

- Cabinet opening dimensions that are shown must be used. Given dimensions provide minimum clearance with oven.
- Recessed installation area must provide complete enclosure around the recessed portion of the oven.
- The oven support surface must be solid, level and flush with the bottom of the cabinet cutout.
- The oven must be able to support the weight of 230 lbs (105 kg) plus 60 lb (28 kg) food load.
- Grounded electrical supply is required. See "Electrical Requirements" section.  
**NOTE:** For undercounter installation, it is recommended that the junction box be located in the adjacent right or left cabinet.
- To avoid damage to your cabinets, check with your builder or cabinet supplier to make sure that the materials used will not discolor, delaminate or sustain other damage. This oven has been designed in accordance with the requirements of UL and CSA International and complies with the maximum allowable wood cabinet temperatures of 194°F.

# INSTALLATION

## Electrical Junction Box Location

**NOTE:** Junction box may be located in adjacent cabinet

| LETTER | DESCRIPTIONS                                  | DOUBLE OVEN IN CABINET |
|--------|---|------------------------|
| A      | Width (cutout)                                | 28 5/8" (72.7 cm)      |
| B      | Height (cutout)                               | 50 1/4" (127.6 cm)     |
| C      | Depth (cutout)                                | 24" (61.0 cm)          |
| D      | Top of Cutout to Bottom of Upper Cabinet Door | 1 1/2" (3.8 cm)        |
| E      | Bottom of Cutout to Floor (recommended)*      | 14 3/4" (37.5 cm)*     |
| F      | Bottom of Cutout to Top of Cabinet Door       | 1 1/2" (3.8 cm)        |
| G      | Overlap of Oven with Sides of Cutout          | 11/16" (1.7 cm)        |

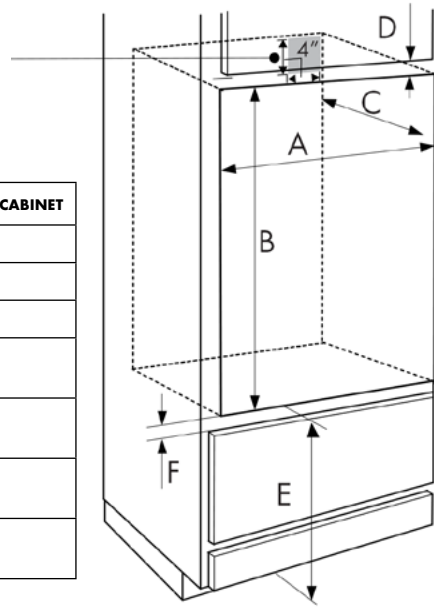

\*Bottom of Cutout to Floor (acceptable) 4" to 14 3/4" (10.2 cm to 37.5 cm)

## STEP 1 - UNPACK THE OVEN

**EXCESSIVE WEIGHT HAZARD:** Use two or more people to move and install oven. Failure to do so can result in back or other injury.

1. Using two or more people, remove the oven and set it on cardboard to avoid floor damage. **NOTE:** Do not use the handle or any portion of the front frame for lifting.
2. Remove the shipping materials and tape from the oven.
3. Remove the hardware package from inside the bag containing literature.
4. Remove and set aside racks and other parts from inside the oven.
5. Move the oven on the cardboard near where it will be installed.

# INSTALLATION



The oven door is heavy and fragile, and the door front is glass. To avoid oven door glass breakage, use both hands, and grasp only the sides of the oven door to remove.

## STEP 2 - REMOVE THE OVEN DOOR

1. Open the oven door.
2. Locate the door latches in both corners of the oven door, and rotate the latches forward to the unlocked position.

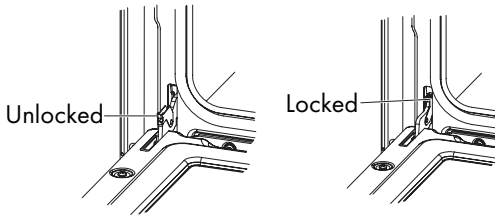

3. Grasp the edges of the oven door with both hands and push the oven door fully closed. Lift up and pull oven door toward you to remove. Set the oven door aside on a covered work surface.

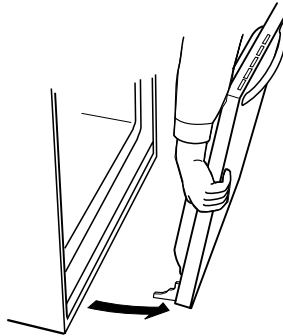

# INSTALLATION

## STEP 3 - INSTALL OVEN

1. Using two or more people, grasp the ceiling of the oven cavity and lift the oven onto a table or platform even with the cutout opening. **NOTE:** The surface must be able to support 160 lb (73 kg).



2. Feed the flexible electrical supply conduit from the oven to the junction box.



## STEP 4 - MAKE ELECTRICAL CONNECTION

To properly install your oven, you must determine the type of electrical connection you will be using and follow the instructions provided for it here.

### ELECTRICAL SHOCK HAZARD

#### DIRECT WIRE

- Disconnect power before servicing.
- Improper connection of aluminum house wiring and copper appliance leads can result in an electrical hazard or re. If the home has aluminum wiring, only use connectors designed and UL listed for joining copper to aluminum and precisely follow the manufacturer's recommended procedure. Aluminum-to- Copper connections must conform with local codes.
- Use 8 gauge copper or aluminum wire.
- Electrically ground oven.



# INSTALLATION

- Failure to do so can result in death or electrical shock.
- Be sure your appliance is properly installed and grounded by a qualified technician. Ask your dealer to recommend a qualified technician or an authorized repair service.
- This oven is manufactured with a neutral (white) power supply wire and a cabinet connected green (or bare) ground wire twisted together.
- After making sure that the power has been turned off, connect the flexible conduit from the oven to the junction box using a UL listed conduit connector. The Grounded Neutral and Ungrounded Neutral Graphics on the following pages and the instructions provided, present the most common way of connecting ovens. Your local codes and ordinances, of course, take precedence over these instructions. Complete electrical connections according to local codes and ordinances.

1. Disconnect power.
2. Remove junction box cover.
3. Install a UL listed or CSA approved conduit connector to the junction box.

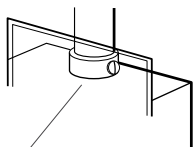

UL or CSA Listed Conduit Connector

4. Route the flexible electrical supply conduit from the oven to the junction box through a UL listed or CSA approved conduit connector.
5. Tighten screws on conduit connector.

# INSTALLATION

## 3-WIRE CONNECTION (GROUNDED NEUTRAL) - U.S.A. ONLY

- Grounding through the neutral conductor is prohibited for new branch-circuit installations (1996 NEC); mobile homes; and recreational vehicles, or in an area where local codes prohibit grounding through the neutral conductor. For installations where grounding through the neutral conductor is prohibited, see the Ungrounded Neutral graphic.
- Use grounding terminal or lead to ground unit. Connect neutral terminal or lead to branch circuit neutral in usual manner.
- Failure to do so could result in death, fire or electric shock.

## 3-WIRE CABLE FROM HOME POWER SUPPLY



Use the 3-wire cable from home power supply where local codes permit a **WARNING** 3-wire connection.

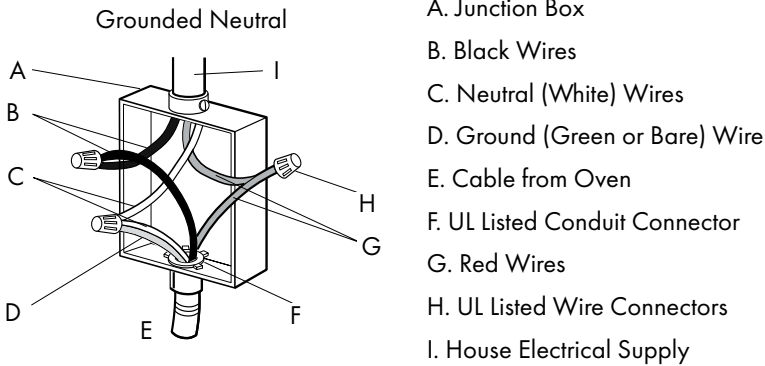

1. Disconnect power.
2. Connect the two black wires B together using a UL listed wire connector.
3. Connect the two neutral (white) wires C and the ground (green or bare) wire d (of the oven cable) using a UL listed wire connector.
4. Connect the two red wires G together using a UL listed wire connector.
5. Install junction box cover.

# INSTALLATION

## 4-WIRE CONNECTION (UNGROUNDING NEUTRAL) - U.S.A. AND CANADA

### 4-WIRE CABLE FROM HOME POWER SUPPLY



**WARNING**

Use the 4-wire cable from home power supply in the U.S. where local codes do not allow grounding through neutral, New Branch circuit installations (1996 NEC), mobile homes and recreational vehicles, new construction and in Canada.

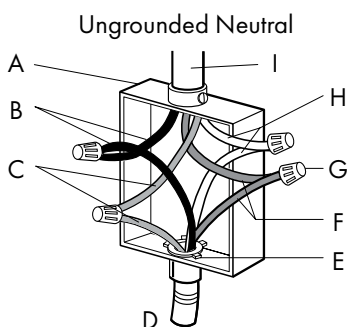

- A. Junction Box
- B. Black Wires
- C. Red Wires
- D. Cable from Oven
- E. UL Listed or CSA Approved Conduit Connector
- F. Ground (Green or Bare) Wires
- G. UL Listed Wire Connector
- H. Neutral (White) Wires
- I. House Electrical Supply

1. Disconnect power.
2. Connect the 2 black wires B together using a UL listed wire connector.
3. Connect the 2 red wires C together using a UL listed wire connector.
4. Untwist white wire from green (or bare) ground wire coming from the oven.
5. Connect the 2 neutral (white) wires H together using a UL listed wire connector.
6. Connect the ground (green or bare) wire FA from the oven cable to the ground (green or bare) wire (in the junction box) using a UL listed wire connector.
7. Install junction box cover.

# INSTALLATION

## STEP 5 - MOUNT THE OVEN

1. Slide the oven completely into the cabinet until the back surface of the front frame touches the front wall of the cabinet. Center the oven within the cabinet cutout. **NOTE:** Push against seal area of the oven front frame when pushing the oven into the cabinet. Do not push against the outside edges.

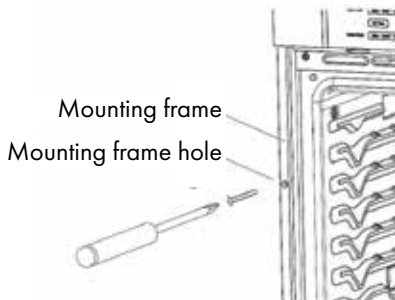

2. There are two holes, one on each side of the front frame that surrounds the oven cavity. Drill 1/8" (3.18 mm) pilot holes through the holes, and into the front wall of the cabinet. There are four mounting holes, two on each side.
3. Insert the # 8-14 x 1" screws (provided) through the pilot holes to securely fasten the oven to the cabinet. Do not overtighten screws.
4. Replace the oven racks. **NOTE:** Ensure all plastic and foam packaging are removed from the oven racks before reinserting them.
5. Reconnect power to the oven.

## STEP 6 - REPLACE THE DOOR

1. Verify that the door hinge latches are forward, and then insert the oven door hinges into the openings.
2. Lower the oven door to engage the hinges.
3. Press the hinge latches down to lock.

# INSTALLATION

## STEP 7 - COMPLETE INSTALLATION

1. Check that all parts are now installed. If there is an extra part, go back through the steps to see which step was skipped.
2. Dispose of/recycle all packaging materials.
3. Check Operation of Oven.
  - Turn on power.
  - Press BROIL.
  - Set the temperature.
  - Press START.

**NOTE:** If oven(s) does not operate, check the following:

  - Household fuse is intact and tight; or circuit breaker has not tripped.
  - Electrical supply is connected.
  - See "Troubleshooting" section in the Operation Manual.
4. When oven has been on for 5 minutes, feel for heat. If you do not feel heat or if an error message appears in the display, turn off the oven and contact a qualified technician.
5. Press STOP/CLEAR to turn off the oven.

For oven use and cleaning, read the user manual.

# OPERATION

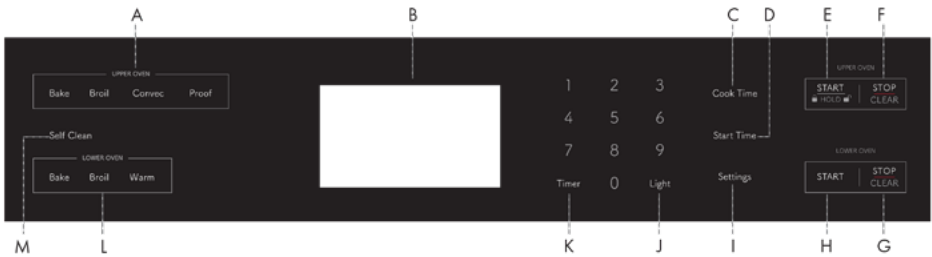

- A. Upper Oven Controls
- B. Display
- C. Cook Time
- D. Start Time
- E. Upper Oven Start
- F. Upper Oven STOP/CLEAR
- G. Lower Oven STOP/CLEAR
- H. Lower Oven Start
- I. Settings
- J. Light
- K. Timer
- L. Lower Oven Controls
- M. Self-Clean

- **OVEN MODE CONTROLS**

- UPPER OVEN: BAKE, BROIL, CONVEC

- PROOF LOWER OVEN: BAKE, BROIL, WARM

- Depending on which oven you are using, select from Bake, Broil, Convec, Proof and Warm oven modes.

## DISPLAY

- When power is first supplied to the oven or if a power failure occurs, "12:00" will appear on the display.
- See "Clock," later in this section, for instructions to set the time-of-day. When the oven is not in use, the time-of-day appears in the display.

## START

- The Start control begins any oven function. If Start is not pressed within 2 minutes after pressing a keypad the function is canceled and the time-of-day is displayed.



# OPERATION

## CONTROL PANEL LOCKOUT

The control panel can be locked to avoid unintended use of the oven.

- The control cannot be locked if the oven is in use or if Cook Time is operating.
- The current time-of-day will remain in the display when the control is locked.

## TO LOCK CONTROL PANEL

- Press and hold START for 3 seconds or until  symbol appears in the display.  
 Symbol will remain lit in the display.

## TO UNLOCK CONTROL PANEL

Press and hold START for 3 seconds or until  symbol disappears.

## STOP/CLEAR

- Press the STOP/CLEAR button to stop any function except Cook Time and Control Panel Lockout.

## LIGHT

- The oven lights turn On automatically.
- Press the Light button to turn On/Off the oven lights when the oven door is closed.

## TIMER

The Timer can be set in hours or minutes up to 12 hours.

## TO SET THE TIMER

1. Press TIMER.
2. Use the number keypad to enter the length of time in hours and minutes.
3. Press TIMER to begin the countdown. If enabled, timer tone(s) will sound at the end of countdown.
4. Press TIMER to cancel the Timer and return to the time-of-day.
  - Do not press STOP/CLEAR because the oven will turn off.

# OPERATION

## COOK TIME

- The Cook Time feature allows the oven to be set to cook for a set length of time, and then turn off automatically.
- You must select an Oven Mode before you can set a Cook Time.
- Cook Time can be set in hours or minutes up to 12 hours.
- At the end of the set cook time, the oven will turn off automatically, the alert tone will sound, and “Cooking Complete” will appear in the text area.
- Cook Time must be off before pressing other buttons. Pressing other buttons will not interrupt the Cook Time.

## TO SET COOK TIME

1. Select cooking mode.
2. Select temperature.
3. Press COOK TIME. Enter the desired cook time by pressing the number keypad.
4. Press START. The oven will begin to preheat.
  - The Cook Time format is HR:MIN, switching to MIN:SEC during the last minute.
  - An alert tone will sound until Cook Time is canceled.

## START TIME

- This feature allows you to set the oven to turn on at a later time.
  - The clock must be set to the correct time-of-day.
1. Select an Oven Mode.
  2. Select temperature.
  3. Set Cook Time.
  4. Press START TIME.
  5. Enter the desired Start Time by pressing the number keypad. “Press START” will appear the display. If Cook Time was not set, the control will prompt you to “Set Cook Time.”



**WARNING**

Do not let food sit in oven more than one hour before or after cooking. Doing so can result in food poisoning or sickness.

6. Place the food in the oven and close the oven door.
7. Press START. Start Time will begin counting down until it reaches the set time-of-day.
  - **NOTE:** At the end of Cook Time, the oven will turn off automatically, an alert tone will sound and “Cooking Complete” will appear in the display.



# OPERATION

## SETTINGS

- The Settings control allows you to access the menu for additional functions and features.
  1. Clock
  2. Temp Unit
  3. Sound
  4. Sound Volume
  5. 12/24 hour
  6. Language
  7. Sabbath
  8. Brightness
  9. Calibration
  - 0 Demo Mode
- Press SETTINGS to show Menu Options 1 - 6. Then, press START to show Options 7 - 0.

## CLOCK

The clock can be set to display time in a 12-hour or 24-hour format. The clock is factory preset for the 12-hour format.

### TO SET THE CLOCK

- Before setting the clock, make sure both the Oven and Timer are turned Off.
  1. Press SETTINGS. The various Options will appear in the display.
  2. Press 1 on the number keypad. "Clock" will appear in the display.
  3. Press the number keypad to enter the time-of-day.
  4. Press START to toggle between AM and PM.
  5. Press SETTINGS to confirm; time-of-day is set.

# OPERATION

## TO CHANGE THE CLOCK TO 24-HOUR FORMAT

1. Press **SETTINGS**. The various Options will appear in the display.
2. Press "5" on the number keypad. "12/24 HOUR" and "12" will appear in the display.
3. Press "1" on the number keypad to change the 12/24 Hour setting to 24-hour.
4. Press **SETTINGS** to confirm. The 12/24-Hour setting has been changed.

## TONES

- Tones are audible signals, indicating the following:
- Number of tones: 1
  - Valid press
  - Function has been entered
  - Oven is preheated
- Number of tones: 2
  - Invalid touch pad press
- Number of tones: 3
  - End of cycle
- Number of tones: 4
  - End of **TIMER**

## TO TURN ON/OFF SOUND

The oven sound is factory preset for On but can be changed to Off.

1. Press **SETTINGS**. The various Options will appear in the display.
2. Press "3" on the number keypad. "SOUND" and "ON" will appear in the display.
3. Press "1" on the number keypad. "ON/OFF" will appear in the display.
4. Press "1" on the number keypad to turn the sound Off.
5. Press **SETTINGS** to confirm. The sound has now been turned off.
6. Press **SETTINGS**, and then follow the display prompts to return the sound setting to On.

# OPERATION

## TO ADJUST SOUND VOLUME

The oven sound is factory preset for High but can be changed to Low.

1. Press **SETTINGS**. The various Options will appear in the display.
2. Press "4" on the number keypad. "SOUND VOLUME" and "HIGH" will appear in the display.
3. Press "1" on the number keypad. "HIGH/LOW" will appear in the display.
4. Press "1" on the number keypad to turn the sound Low.
5. Press **SETTINGS** to confirm. The sound volume has now been changed.
6. Press **SETTINGS**, and then follow the display prompts to return the sound volume setting to High.

## DEGREES FAHRENHEIT AND CELSIUS

- The temperature is factory preset to display in degrees Fahrenheit, but can be changed to display in degrees Celsius.
  - To Change the Display from Degrees Fahrenheit to Degrees Celsius:
1. Press **SETTINGS**. The various Options will appear in the display.
  2. Press "2" on the number keypad. "TEMP UNIT" and "FAHRENHEIT" will appear in the display.
  3. Press "1" on the number keypad. "DEGREE F/C" will appear in the display.
  4. Press "1" on the number keypad to change the temperature unit setting to degrees Celsius.
  5. Press **SETTINGS** to confirm. The temperature unit has been changed.
  6. Press **SETTINGS**, and then follow the display prompts to return to Fahrenheit.

# OPERATION

## SABBATH MODE

The oven is factory preset with Sabbath Mode Off.

### TO TURN ON/OFF SABBATH MODE

1. Make sure the oven is turned Off, and the meat probe is not plugged in. **NOTE:** Sabbath mode cannot be set when the oven is On. The oven will not recognize the meat probe while in Sabbath mode.
2. Press **SETTINGS**, Press **START** to go to the next page, and then press "7".
3. Press "1" to toggle between ON/OFF
4. Press **SETTINGS** again to enable Sabbath mode. The only cooking function that works while the oven is set to Sabbath mode is Bake.

### TO BAKE WHILE THE OVEN IS IN SABBATH MODE

1. Turn on Sabbath mode from **SETTINGS** menu.
2. Enter the desired oven temperature by pressing the numbered keypad.
3. After selecting a Temperature, you have the option to set a Cook Time and Start Time before pressing **START**. See "Cook Time" and "Start Time."
4. Press **START**. Pressing Start activates Sabbath mode.

### ONLY THE STOP/CLEAR CONTROL IS FUNCTIONAL

- Press **STOP/CLEAR** twice to exit Sabbath mode, and resume normal oven operation. The display will return to the time-of-day.
- If there is a power failure while the oven is in Sabbath mode, the oven will exit Sabbath mode and resume in normal mode when power is restored.

## LANGUAGE

The language default for the oven is English.

## BRIGHTNESS

1. Press **SETTINGS** and Press **START** to go to the next page.
2. Press "8" on the number keypad. "BRIGHTNESS" and "HIGH" will appear in the display.
3. Press 1 to toggle between HIGH/LOW.
4. Press **SETTINGS** to confirm.

# OPERATION

## CALIBRATION

See "Oven Temperature Control" on page 29.

## DEMO MODE

1. Press SETTINGS and Press START to go to the next page.
2. Press "0" on the number keypad. "DEMO MODE" and "OFF" will appear in the display.
3. Press "1" to toggle between ON/OFF.
4. Press SETTINGS to confirm.
  - **NOTE:** Oven does not heat in DEMO MODE. The display counts down quickly.

## BEFORE USING THE OVEN

1. Select Bake cooking mode.
2. Set temperature to 500° F.
3. Allow the oven to operate for 30 minutes with the door closed and no food in the cavity. **NOTE:** Any odor that may be detected during this initial use is due to the evaporation of substances used to protect the oven during storage.
4. Turn off the oven, and allow the oven to cool.

## GENERAL

**IMPORTANT:** Do not place anything, including dishes, foil and oven trays, on the bottom of the oven when it is in operation to avoid damaging the enamel.

1. Place bakeware with food on one or both of the shelves provided with the oven.
2. Press the Oven Mode control for the desired oven function.
3. Use the number keypad to enter the oven temperature.
4. Press START.

# OPERATION

## PREHEATING THE OVEN

- Preheat the oven when using the Bake, Convection Bake and Convection Roast modes.
- Selecting a higher temperature does not shorten the preheat time.
- Preheating is necessary for good results when baking cakes, cookies, pastry and breads.
- Preheating will help to sear roasts and seal in meat juices.
- Place oven racks in their proper position before preheating.
- During preheating, the selected cooking temperature is always displayed.
- A beep will confirm that the oven is preheated and the "PREHEAT" writing will turn off.

## OPERATIONAL SUGGESTIONS

- Use the cooking charts, in this manual, as a guide.
- Do not set pans on the open oven door.
- Use the interior oven lights to view the food through the oven door window rather than opening the door frequently

## TEMPERATURE PROBE

- Use an oven mitt to remove temperature probe.
- Do not touch broil element.
- Failure to do so can result in burns.
- The temperature probe monitors the internal food temperature, which is frequently used as an indicator of doneness especially or meats and poultry, and turns off the oven when the internal food temperature reaches the programmed temperature.
- The temperature probe will work with all oven modes except for the Warm/Proof, Sabbath and Self-Clean modes.



**WARNING**

Always unplug and remove the temperature probe from the oven when removing the food.

# OPERATION

## TO USE THE TEMPERATURE PROBE

1. Insert the probe into the food. **NOTE:** For meats, the probe tip should be inserted into the center of the thickest part of the meat. Make sure that the probe tip is not into the fat or touching bone.
2. Place the food into the oven. Keeping the temperature probe as far away from a heat source as possible, plug the temperature probe into the oven outlet. Close the oven door.
3. Select the oven mode.
4. Enter the oven temperature by pressing the numbers on the keypad.
5. Press START. The set oven temperature will appear on the display throughout cooking.
6. Enter the desired internal food temperature by pressing the numbers on the keypad, and then press START.
  - The internal food temperature can be set between 110°F and 200°F.
  - When the set probe temperature is reached, the oven will turn off.
7. Press STOP/CLEAR when finished. Unplug the temperature probe and remove food from the oven. The probe icon will remain lit in the display until the probe is unplugged.

## UTENSILS

- Glass baking dishes absorb heat. Reduce oven temperature 25°F when baking in glass.
- Use pans that produce the desired browning. The type of finish on the pan will help determine the amount of browning that will occur.
  - Shiny, smooth metal or light non-stick / anodized pans reflect heat, resulting in lighter, more delicate browning. Cakes and cookies require this type of utensil.
  - Dark, rough or dull pans will absorb heat resulting in a browner, crisper crust. Use this type for pies.
- Do not cook with the empty broiler pan in the oven, as this could affect cooking performance. Store the broil pan outside of the oven.

# OPERATION

## HIGH ALTITUDE BAKING

When cooking at high altitude, cooking times may be extended.

## OVEN RACKS



**WARNING**

To avoid permanent damage to the porcelain finish, place food or bakeware on an oven rack. Do not place food or bakeware directly onto the oven door or oven bottom.

- The oven racks can be placed in any of the six height positions with the oven.
- Position racks before turning on the oven.
- Make sure the oven racks are level.
- Oven racks have a stop to keep them from being unintentionally withdrawn fully.

## TO REMOVE OVEN RACKS

- Pull rack out to the stop position, raise the front edge, and then lift out.

## TO REPLACE OVEN RACKS

- Place oven rack on the wire supports along the sides of the oven. Tilt the front edge up slightly, and slide rack to the rear until it clears the stop position. Lower the front and slide the rack into the oven.

## COMPONENT COOLING FAN

Activates during any cooking or self-cleaning mode to cool inner components and outer door surfaces. This air is exhausted through the vent located above the oven door. It continues to run until components have cooled sufficiently. The cooling fan operates at double speed (or RPM's) in self-clean and whenever the internal components temperature becomes high.



# OPERATION

## OVEN DOOR

To avoid oven door glass breakage:

- Do not close the oven door if the racks are not fully inserted into the oven cavity or if bakeware extends past the front edge of an oven rack.
- Do not set objects on the glass surface of the oven door.
- Do not hit glass surfaces with bakeware or other objects.
- Do not wipe down glass surfaces until the oven has completely cooled.

## OVEN VENTS

- Blocking or covering the oven vents will cause poor air circulation, affecting cooking, cleaning and cooling results.
- Both the upper and lower oven vent(s) allow fresh air to enter the cooling system.
- The lower oven vent also allows hot air to be expelled from the cooling system.

## OVEN CONDENSATION AND TEMPERATURE

- It is normal for a certain amount of moisture to evaporate from the food during any cooking process. The amount depends on the moisture content of the food.
- The moisture may condense on any surface cooler than the inside of the oven, such as the control panel.
- Your new oven has an electronic temperature sensor to help have had a mechanical thermostat that drifted gradually over time to a higher temperature. It is normal that you may need to adjust your favorite recipes when cooking in a new oven.

# OPERATION

## OVEN TEMPERATURE CONTROL

- The oven provides accurate temperatures; however, it may cook faster or slower than your previous oven, so the temperature calibration can be adjusted. It can be adjusted in degrees Fahrenheit or Celsius.
- A minus sign means the oven will be cooler by the displayed amount. The absence of a minus sign means the oven will be warmer by the displayed amount.
- Use the following chart as a guide:

| ADJUSTMENT (F°) | COOKS FOOD      |
|-----------------|-----------------|
| 10° F           | A little more   |
| 20° F           | Moderately more |
| 30° F           | Much more       |
| -10° F          | A little less   |
| -20° F          | Moderately less |
| -30° F          | Much less       |

## TO ADJUST OVEN TEMPERATURE CALIBRATION

1. Press **SETTINGS**. The various Options will appear in the display.
2. Press number 9 on the keypad. "CALIBRATION" "PRESS TO INCREASE/PRESS 6 TO DECREASE" will scroll across the display.
3. Press number 3 on the keypad to increase or number 6 to decrease the temperature in 5°F increments. The adjustment can be set between 30°F and -30°F.
4. Press **SETTINGS** to save the adjustment, and then exit the Temperature Calibration menu.

# OPERATION

## OVEN MODES

The illustrations show the heating elements and fans used for each oven mode.

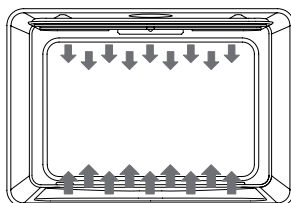

**NOTE:** The lower element is concealed under the oven floor.

### BAKE

- Baking is cooking with heated air. Both upper and lower elements in the oven are used to heat the air but no fan is used to circulate the heat.
  - Follow the recipe or convenience food directions for baking temperature, time and rack position. Baking time will vary with the temperature of ingredients and the size, shape and finish of the bakeware.
1. Press **BAKE** to select the bake mode. "BAKE" will appear in the display and 350°F will be displayed. "Set temp or Press START" will appear in the display.
  2. Press **START**, if you wish to cook at 350°F.

### OR

- Enter the desired temperature by pressing the number keypad, and then press **START**. The temperature can be set from 170°F to 500°F.
  - The temperature can be changed at any time during cooking. Press **STOP/CLEAR** to clear the settings. Select oven mode, then enter the desired temperature by pressing the number keypad, and then press **START**.
  - After selecting an Oven Mode and Temperature, you have the option to set a Cook Time and Start Time before pressing **START**. See "Cook Time" and "Start Time."
3. Press **STOP/CLEAR** when finished baking, and remove food from the oven.

# OPERATION

## BROIL

- Broiling uses direct radiant heat to cook food. The lower the temperature, the slower the cooking. Thicker cuts and unevenly shaped pieces of meat, fish and poultry may cook better at lower broiling temperatures.

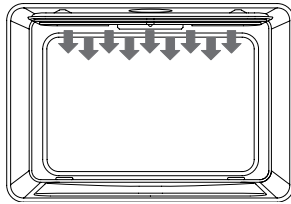

- For best results, use a broiler pan and rack. It is designed to drain juices and help avoid spatter and smoke.
- For proper draining, do not cover the grid with foil. The bottom of the pan may be lined with aluminum foil for easier cleaning.
- Trim excess fat to reduce spattering. Slit the remaining fat on the edges to avoid curling.
- Select HI/550°F broil for most broiling. Select LO/450°F broil for low-temperature broiling of longer cooking foods such as poultry to avoid over browning.
- Pull out oven rack to stop position before turning or removing food. Use tongs to turn food to avoid the loss of juices. Very thin cuts of fish, poultry or meat may not need to be turned.

## TO BROIL

1. Place the food on the rack in the broiler pan and place pan in the oven. Close the oven door. Preheating is not necessary.
2. Press BROIL for the desired mode. "BROIL" and "Set temp or Press START" will appear in the display, and "550°F" will be displayed.
3. Press START, if you wish to broil at 550°F.

### OR

- Enter the desired temperature by pressing the number keypad, and then press START. The temperature can be set from 450°F to 550°F.
4. "BROIL" will appear in the display after Start is pressed

# OPERATION

- The broil temperature can be changed at any time during cooking. Press STOP/CLEAR to clear the settings. Select oven mode, then enter the desired temperature by pressing the number keypad, and then press START.
  - After selecting an Oven Mode and Temperature, you have the option to set a Cook Time and Start Time before pressing START. See “Cook Time” and “Start Time.”
5. Press STOP/CLEAR when finished broiling, and remove food from the oven.

## WARM (LOWER OVEN)

The Warm mode keeps hot, cooked foods at serving temperature.

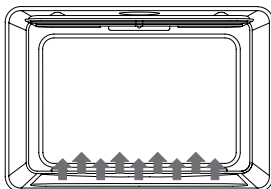

**WARNING** Do not let food sit in oven more than one hour before or after cooking. Doing so can result in food poisoning or sickness.

- Food must be at serving temperature before placing it in the warmed oven. Food may be held up to 1 hour; however, breads and casseroles may become too dry if left in the oven during the Warm function. For best results, cover food.
1. Press WARM. “Warm” and “Set Temp or Press START” and 140°F will be displayed.
  2. Use the number keypad to enter the desired temperature. The temperature can be set from 140°F to 210°F.
  3. Press START. “WARM” and the set temperature will appear in the display.
  4. Place food in the oven and close the door.
  5. Press STOP/CLEAR when finished, and remove food from the oven.

# OPERATION

## TO CANCEL WARM FEATURE

Press STOP/CLEAR. Remove food from oven.

## PROOF (UPPER OVEN)

1. Before proofing, place the dough in a lightly greased bowl and cover loosely with wax paper, coated with shortening. Place on second rack from the bottom and close the oven door.
2. Press PROOF. "PROOF" and "Set Temp or Press START" and 100°F will be displayed.
3. Use the number keypad to enter the desired temperature. The temperature can be set from 80°F to 120°F.
4. Press START.
5. Let the dough rise until nearly doubled in size, checking after 20-25 minutes. Proofing time may vary depending on dough type and quality.
6. Press STOP/CLEAR when finished proofing.
7. Before seconding proofing, shape the dough, place it in baking pan(s) and cover loosely with plastic wrap, coated with cooking spray. Follow the same placement and control steps above. Before baking, remove the plastic wrap.

## CONVECTION

- During convection cooking, the fan provides hot air circulation throughout the oven. The movement of heated air around the food can help to speed up cooking by penetrating the cooler outer surfaces.
- In Convection mode, the ring element, bake and broil elements, and the fan operate to heat the oven cavity. If the oven door is opened during convection cooking or preheating, the fan turns off immediately and the element(s) will turn off after 30 seconds. Once the door is closed, the element(s) will turn back on.

## CONVECTION FAN

- The convection fan operates during any convection mode. When the oven is operating in convection mode, the fan will turn off automatically when the door is opened. The convection fan always runs during the preheat time.

# OPERATION

## ADVANTAGES OF CONVECTION COOKING

- Saves time and energy.
- Even baking, browning and crisping are achieved.
- During roasting, juices and flavors are sealed in while the exterior is crisp.
- Yeast breads are lighter, more evenly textured, more golden and crustier.
- Air-leavened foods such as cream puffs, soufflés and meringues are higher and lighter.
- Baking on multiple racks at the same time with even results is possible.
- Dehydrates herbs, fruits and vegetables.
- Requires no specialized bakeware.
- Convection broiling allows for extraordinary grilling with thicker cuts of food.

# OPERATION

## CONVECTION BAKE

- Use Convection bake for single or multiple rack baking. When convection baking, reduce your recipe baking temperature by 25°F.

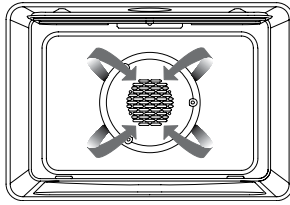

## TO SET CONVECTION BAKE

1. Press CONVEC. "Convection" and "Press 1-3 To Choose" will appear in the display.
2. Press number 1 on the keypad. "Convect Bake" and "Set Temp or Press START" and 325°F will be displayed.
3. Press START if you wish to convection bake at 325°F.  
OR
  - Enter the desired temperature by pressing the number keypad, and then press START. The temperature can be set from 170°F to 500°F .

**NOTE:** After selecting an Oven Mode and Temperature, you have the option to set a Cook Time and Start Time before pressing START. See "Cook Time" and "Start Time."

4. The oven will begin preheating once Start is pressed. A tone will sound when the oven is at the set temperature.
5. Place the food in the oven and close the oven door when preheat is completed.
6. Press STOP/CLEAR when finished and remove food from the oven.



# OPERATION

## CONVECTION BROIL

When convection broiling, enter your normal broiling temperature. The oven door must be closed when using Convection Broil. It is not necessary to preheat the oven for Convection Broil.

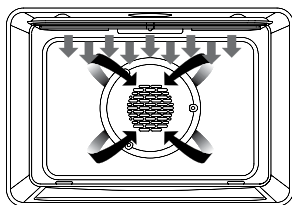

1. Place the food in the oven and close the oven door.
2. Press CONVEC. "Convection and "Press 1-4 To Choose" will be displayed.
3. Press number 2 on the keypad. "Convect Broil" and "Set Temp or Press Start" and 450°F will be displayed.
4. Press START, if you wish to broil at 450°F.  
OR
  - Enter the desired temperature by pressing the number keypad, and then press START. The temperature can be set from 170°F to 550°F.

**NOTE:** After selecting an Oven Mode and Temperature, you have the option to set a Cook Time and Start Time before pressing START. See "Cook Time" and "Start Time."

5. "Convect Broil" will be displayed, once Start is pressed.
6. Press STOP/CLEAR when finished, and remove food from the oven.

# OPERATION

## CONVECTION ROAST

When Convection roasting, enter your normal roasting temperature. The roasting time should be 15-30% less than in conventional cooking. It is not necessary to preheat the oven for convection roast.

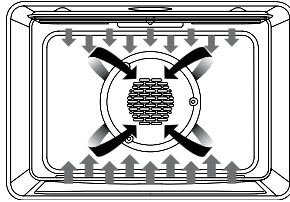

1. Place the food in the oven and close the oven door.
2. Press CONVEC. "Convection" and "Press 1-4 To Choose" will be displayed.
3. Press number 3 on the keypad. "Convect Roast," "Set Temp or Press START", and 325°F will be displayed.
4. Press START, if you wish to convection roast at 325°F.

OR

- Enter the desired temperature by pressing the number keypad, and then press START. The temperature can be set from 170°F to 500°F.

**NOTE:** After selecting an Oven Mode and Temperature, you have the option to set a Cook Time and Start Time before pressing START. See "Cook Time" and "Start Time."

5. "Convect Roast" will be displayed, once Start is pressed.
6. Press STOP/CLEAR when finished and remove food from the oven.

## STEAM CLEAN FUNCTION

- Test method: mix the ingredients for Steam Clean (85% water, 10% white vinegar, 5% dish washing liquid), evenly spray it to the surrounding and bottom of the cavity, and spray on the door glass, then pour 40mL water on the bottom panel.
- Press the key to start the Conv. Roast mode, set the temperature at 248°F After 20 minutes, turn of the oven, wait until cooling to proper temperature, then wipe it up with a damp cloth.

# OPERATION

## CONVECTION CONVERSION

- Convection conversion can be used to convert from conventional cooking to convection cooking. This function will automatically convert the cooking temperature and cooking time to recommended cooking settings.
- As a result, the cooking temperature is lower and the cooking time is shorter. Options that can be selected include Meats, Baked Goods or Others.
- When using convection conversion, enter the normal cooking temperature and time.
- The oven door must be closed before setting Convection Conversion.

## MEATS (ONLY)

- It is not necessary to preheat the oven for the Convection Conversion MEATS option. Preheating can cause overcooking. If preheat is required for the recipe, add 15 minutes to the Cook Time, and place food in the oven at the appropriate time.
1. Place food in the oven and close the door.
  2. Press CONVEC. "Convection and Press 1-4 To Choose" will be displayed
  3. Press number 4 on the keypad. "Convect Convert and Press 1-3 To Choose" will be displayed.
  4. Press number 2 on the keypad. "Meats" and 350°F will be displayed.
  5. Enter your normal roasting temperature by pressing the number keypad.
  6. Enter your normal Cook Time. See "Cook Time," and then press START.

## BAKED GOODS AND OTHERS (ONLY)

1. Preheating will start. Once the oven is preheated to the set temperature, the control will beep. Place the food in the oven and close the oven door.
2. At the end of the set cooking time, the oven will turn off automatically. The alert tone will sound, and "Cooking Complete" will appear in the display.
3. Press STOP/CLEAR when finished and remove food from the oven.

# OPERATION

## BAKE TIPS

- For best results, bake food on a single rack with at least 1"-1 ½" (2.5-3 cm) space between utensils and oven walls.
- Use one rack when selecting the bake mode.
- Check for doneness at the minimum time.
- Use metal bakeware (with or without a non stick finish), heatproof glass, glass-ceramic, pottery or other utensils suitable for the oven.
- When using heatproof glass, reduce temperature by 25F from recommended temperature.
- Use baking sheets with or without sides or jelly roll pans.
- Dark metal pans or nonstick coatings will cook faster with more browning, insulated bakeware will slightly lengthen the cooking time for most foods.
- Do not use aluminum foil or disposable trays to line any part of the oven. Foil is an excellent heat insulator and heat will be trapped beneath it. This will alter the cooking performance and can damage the finish of the oven.
- Avoid using the opened door as a shelf to place pans.
- See Troubleshooting for tips for Baking and Roasting problems.

| FOOD ITEM                 | RACK POSITION | TEMP °F (PREHEATED OVEN) | TIME (MIN.) |
|---------------------------|---------------|--------------------------|-------------|
| CAKE                      |               |                          |             |
| Cupcake                   | 2             | 350° F                   | 19-22       |
| Bundt cake                | 1             | 350° F                   | 40-45       |
| Angel Food                | 1             | 350° F                   | 35-39       |
| PIE                       |               |                          |             |
| 2 crust, fresh 9"         | 2             | 375-400° F               | 45-40       |
| 2 crust, frozen fruit, 9" | 2             | 375° F                   | 68-78       |
| COOKIES                   |               |                          |             |
| Sugar                     | 2             | 350-375° F               | 8-10        |
| Chocolate chip            | 2             | 350-375° F               | 8-13        |
| Brownies                  | 2             | 350° F                   | 29-36       |
| BREADS                    |               |                          |             |
| Yeast bread, 9x5          | 2             | 375° F                   | 18-22       |
| Yeast rolls               | 2             | 375-400° F               | 12-15       |
| Biscuits                  | 2             | 375-400° F               | 7-9         |
| Muffins                   | 2             | 425° F                   | 15-19       |
| PIZZA                     |               |                          |             |
| Frozen                    | 2             | 400-450° F               | 23-26       |
| Fresh                     | 2             | 475° F                   | 15-18       |

# OPERATION

## CONVECTION BAKE TIPS

- Reduce recipe baking temperatures by 25°F.
- For best results, foods should be cooked uncovered, in lowsided pans to take advantage of the forced air circulation. Use shiny aluminum pans for best results unless otherwise
- Heatproof glass or ceramic can be used. Reduce temperature by another 25°F when using heatproof glass dishes for a total reduction of 50°F.
- Dark metal pans may be used. Note that food may brown faster when using dark metal bake ware.
- The number of racks used is determined by the height of the food to be cooked.
- Baked items, for the most part, cook extremely well in convection. Don't try to convert recipes such as custards, quiches, pumpkin pie, or cheesecakes, which do not benefit from the convection-heating process. Use the regular Bake mode for these foods.
- Multiple rack cooking for oven meals is done on rack positions 1, 2, 3, 4 and 5. All six racks can be used for cookies, biscuits and appetizers.
  - 2 Rack baking: Use positions 1 and 3.
  - When baking four cake layers at the same time, stagger pans so that one pan is not directly above another. For best results, place cakes on front of upper rack and back of lower rack (See graphic below). Allow 1" - 1 ½" (2.5 - 3 cm) air space around pans.

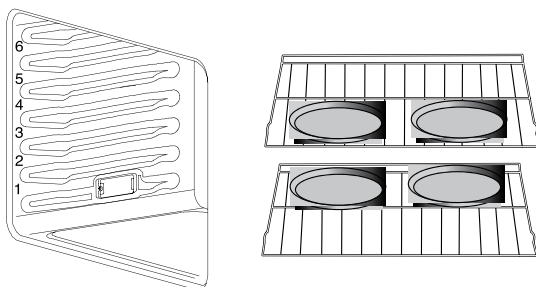

- Converting your own recipe can be easy. Choose a recipe that will work well in convection.
- Reduce the temperature and cooking time if necessary. It may take some trial and error to achieve a perfect result. Keep track of your technique for the next time you want to prepare the recipe using convection.
- See Troubleshooting for tips for Baking and Roasting problems.

# OPERATION

## FOODS RECOMMENDED FOR CONVECTION BAKE MODE

- Appetizers, Biscuits, Coffee Cakes
- Cookies (2 to 4 racks), Yeast Breads
- Cream Puffs, Popovers
- Casseroles and One-Dish Entrees
- Oven Meals (rack positions 1, 2, 3)
- Air-Leavened Foods (Soufflés, Meringue, Meringue-Topped Desserts, Angel Food Cakes, Chiffon Cakes)

## CONVECTION BAKE CHART

Reduce standard recipe temperature by 25 °F for Convection Bake. Temperatures have been reduced in this chart.

| FOOD ITEM                 | RACK POSITION | TEMP °F (PREHEATED OVEN) | TIME (MIN.) |
|---------------------------|---------------|--------------------------|-------------|
| CAKE                      |               |                          |             |
| Cupcake                   | 2             | 325° F                   | 20-22       |
| Bundt cake                | 1             | 325° F                   | 43-50       |
| Angel Food                | 1             | 325° F                   | 43-47       |
| PIE                       |               |                          |             |
| 2 crust, fresh 9"         | 2             | 350-400° F               | 40-52       |
| 2 crust, frozen fruit, 9" | 2             | 350° F                   | 68-78       |
| COOKIES                   |               |                          |             |
| Sugar                     | 2             | 325-350° F               | 8-10        |
| Chocolate chip            | 2             | 325-350° F               | 8-13        |
| Brownies                  | 2             | 325° F                   | 29-36       |
| BREADS                    |               |                          |             |
| Yeast bread, 9x5          | 2             | 350° F                   | 18-22       |
| Yeast rolls               | 2             | 350-375° F               | 12-15       |
| Biscuits                  | 2             | 375° F                   | 8-10        |
| Muffins                   | 2             | 400° F                   | 17-21       |
| PIZZA                     |               |                          |             |
| Frozen                    | 2             | 375-425° F               | 23-26       |
| Fresh                     | 2             | 450° F                   | 15-18       |

## CONVECTION ROAST TIPS

- Do not preheat for Convection Roast.
- Roast in a low-sided, uncovered pan.
- When roasting whole chicken or turkey, tuck wings behind back and loosely tie legs with kitchen string.



# OPERATION

- Use the 2-piece broil pan for roasting uncovered.
- Use an oven mitt to remove temperature probe.
- Do not touch broil element. Failure to do so can result in burns.
- Use the probe or a meat thermometer to determine the internal doneness on “END” temperature (see cooking chart).
- Double-check the internal temperature of meat or poultry by inserting meat thermometer into another position.
- Large birds may also need to be covered with foil (and pan roasted) during a portion of the roasting time to prevent over-browning.
- The minimum safe temperature for stuffing in poultry is 165°F.
- After removing the item from the oven, cover loosely with foil for 10 to 15 minutes before carving if necessary to increase the final foodstuff temperature by 5° to 10°F (3° to 6° C).

| MEAT                                | WEIGHT (LB) | OVEN TEMP °F | RACK POSITION | TIME (MIN. PER LB) | INTERNAL TEMP. °F                   |
|-------------------------------------|-------------|--------------|---------------|--------------------|-------------------------------------|
| BEEF                                |             |              |               |                    |                                     |
| Rib Roast                           | 4-6         | 325° F       | 2             | 16-20<br>18-22     | 145° F medium rare<br>160° F medium |
| Rib Eye Roast (boneless)            | 4-6         | 325° F       | 2             | 16-20<br>18-22     | 145° F medium rare<br>160° F medium |
| Rump, Eye, Trip, Sirloin (boneless) | 3-6         | 325° F       | 2             | 16-20<br>18-22     | 145° F medium rare<br>160° F medium |
|                                     | 3-6         | 325° F       | 2             | 16-20<br>18-22     | 145° F medium rare<br>160° F medium |
| Tenderloin Roast                    | 2-3         | 400° F       | 2             | 15-20              | 145° F medium rare                  |
| PORK                                |             |              |               |                    |                                     |
| Loin Roast<br>(boneless or bone-in) | 5-8         | 350° F       | 2             | 16-20              | 160° F medium                       |
| Shoulder                            | 3-6         | 350° F       | 2             | 20-25              | 160° F medium                       |
| POULTRY                             |             |              |               |                    |                                     |
| Chicken whole                       | 3-4         | 375° F       | 2             | 18-21              | 180° F                              |
| Turkey, not stuffed                 | 12-15       | 325° F       | 1             | 10-14              | 180° F                              |
| Turkey, not stuffed                 | 16-20       | 325° F       | 1             | 9-11               | 180° F                              |
| Turkey, not stuffed                 | 21-25       | 325° F       | 1             | 6-10               | 180° F                              |
| Turkey Breast                       | 3-8         | 325° F       | 1             | 15-20              | 170° F                              |
| Cornish Hen                         | 1-1.5       | 350° F       | 2             | 45-75 total        | 180° F                              |
| LAMB                                |             |              |               |                    |                                     |
| Half leg                            | 3-4         | 325° F       | 2             | 22-27<br>28-33     | 160° F medium<br>170° F well        |
| Whole leg                           | 6-8         | 325° F       | 1             | 22-27<br>28-33     | 160° F medium<br>170° F well        |

# OPERATION

## CONVECTION BROIL TIPS

- Place rack in the required position needed before turning on the oven.
- Use Convection Broil mode with the oven door closed.
- Do not preheat oven.
- Use the 2-piece broil pan.
- Turn meats once halfway through the cooking time (see convection broil chart).

| FOOD AND THICKNESS         | RACK POSITION | BROIL SETTING °F | INTERNAL TEMP °F | TIME SIDE 1 (MIN) | TIME SIDE 2 (MIN) |
|----------------------------|---------------|------------------|------------------|-------------------|-------------------|
| <b>BEEF</b>                |               |                  |                  |                   |                   |
| Steak (1.5" or more)       |               |                  |                  |                   |                   |
| Medium Rare                | 4             | 450° F           | 145° F           | 9-12              | 8-10              |
| Medium                     | 4             | 450° F           | 160° F           | 11-13             | 10-12             |
| Well                       | 4             | 450° F           | 170° F           | 18-20             | 16-17             |
| Hamburgers (more than 1")  |               |                  |                  |                   |                   |
| Medium                     | 4             | 550° F           | 160° F           | 8-11              | 5-7               |
| Well                       | 4             | 550° F           | 170° F           | 11-13             | 8-10              |
| <b>POULTRY</b>             |               |                  |                  |                   |                   |
| Chicken quarters           | 4             | 450° F           | 180° F           | 16-18             | 10-13             |
| Chicken halves             | 4             | 450° F           | 180° F           | 25-27             | 15-18             |
| Chicken breasts            | 4             | 450° F           | 170° F           | 13-15             | 9-13              |
| <b>PORK</b>                |               |                  |                  |                   |                   |
| Pork chops (1.25" or more) | 4             | 450° F           | 160° F           | 12-14             | 11-13             |
| Sausage - fresh            | 4             | 450° F           | 160° F           | 4-6               | 3-5               |

- Broiling and convection broiling times are approximate and may vary slightly. Cooking times are indicative and also depend on the thickness and the starting temperature of the meat before cooking.



# OPERATION

## DEHYDRATE TIPS

The circulating heated air at a lower temperature slowly removes the moisture for food preservation.

- Oven temperature for dehydrating is between 120°F (49°C) to 160°F (71°C).
- Multiple racks can be used simultaneously.
- Some foods require as much as 14-15 hours of time to fully dehydrate. Consult a food preservation book for specific times and the handling of various foods.
- This mode is suitable for a variety of fruits, vegetables, herbs and meat strips.
- Drying screens can be purchased at specialty kitchen shops.
- By using paper towels, some food moisture can be absorbed before dehydrating begins (such as with sliced tomatoes or sliced peaches).

| FOOD                                      | PREPARATION   | APPROXIMATE DRYING TIME (HRS) | TEST FOR DONENESS   |
|---|---|-------------------------------|---|
| <b>FRUIT</b>                              |   |                               |   |
| Apple                                     | Dipped in 1/4 cup lemon juice and 2 cups water, 1/4 slices                                    | 11-15                         | Slightly pliable  |
| Bananas                                   | Dipped in 1/4 cup lemon juice and 2 cups water, 1/4 slices                                    | 11-15                         | Slightly pliable  |
| Cherries                                  | Wash and towel dry. For fresh cherries, remove pits   | 10-15                         | Pliable, leathery, chewy  |
| Orange peels and slices                   | 1/4 slices of orange; orange part of skin thinly peeled from oranges                          | Peels: 2-4<br>Slices: 12-16   | Orange peel: dry and brittle<br>Orange slices: skins are dry and brittle, fruit is slightly moist |
| Pineapple rings                           | Towel dry   | Canned: 9-13<br>Fresh: 8-12   | Soft and pliable  |
| Strawberries                              | Wash and towel dry. Slice 1/2" thick, skin (outside) down on rack                             | 12-17                         | Dry, brittle  |
| <b>VEGETABLE</b>                          |   |                               |   |
| Peppers                                   | Wash and towel dry. Remove membrane of pepper, coarsely chop about 1" pieces                  | 16-20                         | Leathery with no moisture inside  |
| Mushrooms                                 | Wash and towel dry. Cut off stem end. Cut into 1/8" slices                                    | 7-12                          | Tough and leathery, dry   |
| Tomatoes                                  | Wash and towel dry. Cut thin slices, 1/8" thick, dry well                                     | 16-23                         | Dry, brick red color  |
| <b>HERBS</b>                              |   |                               |   |
| Oregano, sage, parsley, thyme, and fennel | Rinse and dry with paper towel  | Dry at 120° F<br>3-5 hours    | Crisp and brittle   |
| Basil                                     | Use basil leaves 3 to 4 inches from the top. Spray with water, shake off moisture and pat dry | Dry at 120° F<br>3-5 hours    | Crisp and brittle   |

# OPERATION

## BROIL TIPS

- Place rack in the required position needed before turning on the oven.
- Use Broil mode with the oven door closed.
- Preheat oven for 5 minutes before use.
- Use the 2-piece broil pan.
- Turn meats once halfway through the cooking time (see convection broil chart).

| FOOD AND THICKNESS      | RACK POSITION | BROIL SETTING °F | INTERNAL TEMP °F | TIME SIDE 1 (MIN) | TIME SIDE 2 (MIN) |
|-------------------------|---------------|------------------|------------------|-------------------|-------------------|
| <b>BEEF</b>             |               |                  |                  |                   |                   |
| Steak (3/4"-1")         |               |                  |                  |                   |                   |
| Medium Rare             | 5             | 5                | 145° F           | 5-7               | 4-6               |
| Medium                  | 5             | 5                | 160° F           | 6-8               | 5-7               |
| Well                    | 5             | 5                | 170° F           | 8-10              | 7-9               |
| Hamburgers (3/4"-1")    |               |                  |                  |                   |                   |
| Medium                  | 4             | 5                | 160° F           | 8-11              | 6-9               |
| Well                    | 4             | 5                | 170° F           | 10-13             | 8-10              |
| <b>POULTRY</b>          |               |                  |                  |                   |                   |
| Breast (bone in)        | 4             | 4                | 170° F           | 10-12             | 8-10              |
| Thigh (very well done)  | 4             | 3                | 180° F           | 28-30             | 13-15             |
| <b>PORK</b>             |               |                  |                  |                   |                   |
| Park chops (1")         | 5             | 5                | 160° F           | 7-9               | 5-7               |
| Sausage - fresh         | 5             | 5                | 160° F           | 5-7               | 3-5               |
| Ham slice (1/2')        | 5             | 5                | 160° F           | 4-6               | 3-5               |
| <b>LAMB</b>             |               |                  |                  |                   |                   |
| Chops (1")              |               |                  |                  |                   |                   |
| Medium rare             | 5             | 5                | 145° F           | 5-7               | 4-6               |
| Medium                  | 5             | 5                | 160° F           | 6-8               | 4-6               |
| Well                    | 5             | 5                | 170° F           | 7-9               | 5-7               |
| <b>BREAD</b>            |               |                  |                  |                   |                   |
| Garlic bread, 1" slices | 3             | 5                |                  | 4-6               |                   |

- Broiling and convection broiling times are approximate and may vary slightly. Cooking times are indicative and also depend on the thickness and the starting temperature of the meat before cooking.

# OPERATION

| FOOD SERVICE TEMPERATURE GUIDELINES FROM FSIS<br>USDA FOOD SAFETY & INSPECTION SERVICE |   |
|--|---|
| 140° F   | Ham, precooked (to reheat)                          |
| 145° F   | Fresh beef, veal, lamb (medium rare)                |
| 160° F   | Ground meat & meat mixtures (beef, pork, veal lamb) |
| 160° F   | Fresh beef, veal, lamb (medium)                     |
| 160° F   | Fresh pork (medium)                                 |
| 160° F   | Egg dishes  |
| 160° F   | Ground meat & meat mixtures (turkey, chicken)       |
| 165° F   | Stuffing (cooked alone or in bird)                  |
| 165° F   | Leftovers & casseroles                              |
| 170° F   | Fresh beef, veal, lamb (well done)                  |
| 170° F   | Poultry breast                                      |
| 170° F   | Fresh pork (well done)                              |
| 180° F   | Chicken and turkey (whole)                          |
| 180° F   | Poultry (thighs and wings)                          |
| 180° F   | Duck and goose                                      |

- Eggs (alone, not used in a recipe) – cook until yolk & white are firm.
- On models without a temperature probe, use a meat thermometer to determine whether meat, poultry and fish are cooked to the desired degree of doneness. The internal temperature, not appearance, should be used to determine doneness.

# CLEANING AND MAINTENANCE

## GENERAL CLEANING



Before Cleaning, make sure all controls are off and the oven is cool. Always follow the instructions printed on the label of the cleaning products.

1. Locate the number of the part to be cleaned in the following illustration.
2. Find the part name in the chart.
  - Use the cleaning method in the left column if the oven is black or white.
  - Use the cleaning method in the right column if the oven is stainless steel.
3. Match the letter with the cleaning method on following chart.

| PART |                      | CLEANING METHOD |
|------|----------------------|-----------------|
| 1    | Control panel        | C-G             |
| 2    | Door cooling vent    | E               |
| 3    | Side trim            | D               |
| 4    | Bottom trim          | D               |
| 5    | Door frame           | E               |
| 6    | Door handle          | G               |
| 7    | Interior door window | F               |
| 8    | Door front           | C & G           |
| 9    | End caps             | D               |
| 10   | Interior oven door   | E               |
| 11   | Oven front frame     | E               |
| 12   | Oven cavity          | E               |
| 13   | Door gasket          | B               |
| 14   | Oven cooling vents   | D               |
| 15   | Oven rack            | A               |
| 16   | Broiler pan rack     | E               |
| 17   | Broiler pan          | E               |
| 18   | Temperature probe    | A               |

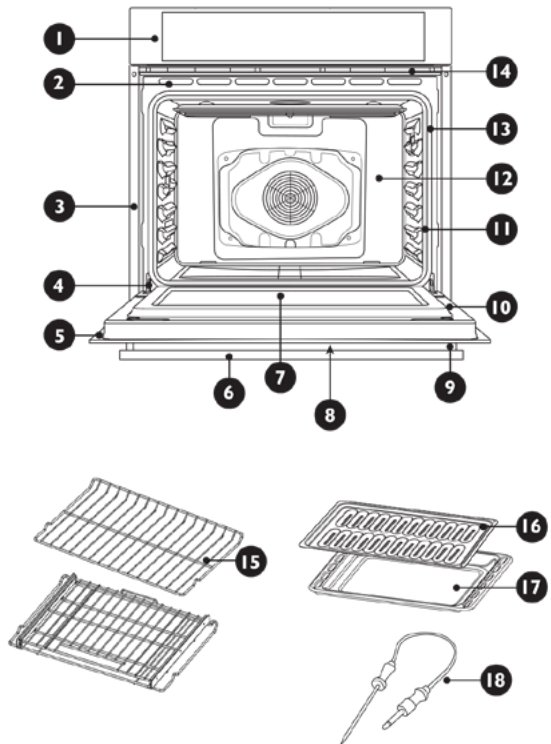

# CLEANING AND MAINTENANCE

| PART |                  | CLEANING METHOD   |
|------|------------------|---|
| A    | Chrome plated    | <p>Wash with hot sudsy water. Rinse thoroughly and dry. Or, gently rub with Soft Scrub<sup>®</sup>, Bon-Ami<sup>®</sup>, Comet<sup>®</sup>, Ajax<sup>®</sup>, Brillo<sup>®</sup>, or S.O.S.<sup>®</sup> pads as directed. Easy Off<sup>®</sup> or Dow<sup>®</sup> oven cleaners (cold oven formula) can be used, but may cause darkening and discoloration.</p> <p>Racks may be cleaned in the oven during the Self-Cleaning mode. However, chromed racks will lose their shiny finish and permanently change to a metallic gray.</p> |
| B    | Fiberglass knit  | DO NOT HANDLE CLEAN GASKET  |
| C    | Glass            | <p>Spray Windex<sup>®</sup> or Glass Plus<sup>®</sup> onto a cloth first, then wipe to clean. Use Fantastik<sup>®</sup> or Formula409<sup>®</sup> to remove grease spatters.</p>  |
| D    | Painted          | Clean with hot sudsy water or apply Fantastik <sup>®</sup> for Formula <sup>®</sup> first to a clean sponge or paper towel and wipe clean. Avoid using powdered cleansers and steel wood pads.  |
| E    | Porcelain        | Immediately wipe up acidic spills like fruit juice, milk, and tomatoes with a dry towel. Do not use moistened sponge/towel on hot porcelain. When cool, clean with hot sudsy water or apply Bon-Ami <sup>®</sup> or Soft Scrub <sup>®</sup> to a damp sponge. Rinse and dry. For stubborn stains, gently use Brillo <sup>®</sup> or S.O.S. <sup>®</sup> pads. It is normal for porcelain to craze (fine lines) with age due to exposure from heat and food soil.  |
| F    | Reflective glass | Clean with hot sudsy water and sponge or plastic scrubber. Rub stubborn stains with vinegar, Windex <sup>®</sup> , ammonia, or Bon-Ami <sup>®</sup> . DO NOT USE HARSH ABRASIVES.   |
| G    | Stainless        | <p>Always wipe or rub with grain. Clean with a soapy sponge then rinse and dry. Or wipe with Fantastik<sup>®</sup> or Formula 409<sup>®</sup> sprayed onto a paper towel. Protect and polish with Stainless Steel Magic<sup>®</sup> and a soft cloth. Remove water spots with a cloth dampened with white vinegar. Use Zud<sup>®</sup>, Cameo<sup>®</sup>, Bar Keeper's Friend<sup>®</sup>, or RevereWare Stainless Steel Cleaner<sup>®</sup>, to remove heat discoloration.</p>  |

# MAINTENANCE AND CLEANING

## OVEN FINISHES / CLEANING METHODS

- The entire oven can be safely cleaned with a soapy sponge, rinsed and dried. If stubborn soil remains, follow the recommended cleaning methods below.
- Always use the mildest cleaner that will do the job.
- Rub metal finishes in the direction of the grain.
- Use clean, soft cloths, sponges or paper towels.
- Rinse thoroughly with a minimum of water so it does not drip into door slots.
- Dry to avoid water marks. The cleaners listed below indicate types of products to use and are not being endorsed. Use all products according to package directions.

## AUTOMATIC SELF-CLEANING

- Do not touch the oven during the Self-Cleaning cycle.
- Keep children away from oven during Self-Cleaning cycle.
- Failure to do so can result in burns.
- This oven features a self-cleaning function that eliminates the need to manually scrub the oven interior. During self-cleaning, the oven uses very high temperatures, burning soil to a powdery ash.



 **WARNING** The health of some birds is extremely sensitive to the fumes given off during the Self-Cleaning cycle. Exposure to the fumes may result in death to certain birds. Always move birds to another closed and well-ventilated room.

- Keep the kitchen well ventilated during the Self-Cleaning cycle to help get rid of heat, odors and smoke.
- It is common to see smoke and/or an occasional flame-up during the Self-Clean cycle, depending on the content and amount of soil remaining in the oven. If a flame persists, turn off the oven and allow it to cool before opening the door to wipe up the excessive food soil.
- Do not block the oven vent(s) during the Self-Cleaning cycle. Air must be able to move freely. See "Oven Vents" on page 28.
- Do not clean, rub, damage or move the oven door gasket.
- The door latch is automatically activated after selecting the Self-Clean cycle. "AUTO LOCK" will appear in the display. This ensures that the oven door cannot be opened while the oven interior is at clean temperatures.

# MAINTENANCE AND CLEANING

- The oven is preset for a 2.5 hour clean cycle; however, the time can be changed. Suggested clean times are 2 hours for light soil and between 3.0 hours and 3.5 hours for average to heavy soil.
- Clean mode stops automatically at the end of the set cleaning time.
- When the oven heat drops to a safe temperature, the automatic door lock will release and the door can be opened.
- The oven light does not operate during Clean mode.

## BEFORE SELF-CLEANING

1. Remove all utensils and bakeware.
2. Remove non-porcelain oven racks. If chromed racks are left in the oven during the self-clean cycle, they will permanently lose the shiny finish and change to a dull dark finish. See "Oven Finishes/Cleaning Methods" for proper care on page 48.
3. Wipe up any soft soil spills and grease with paper towels. Excess grease will cause flames and smoke inside the oven during self-cleaning.
4. Be sure oven interior lights are turned off and the light bulbs and lens covers are in place.
5. Some areas of the oven such as the oven door edge, oven door window, oven front frame and up to 1 1/2" (2-3 cm) inside the frame do not get hot enough during the cleaning cycle for soil to burn away and must be cleaned by hand. BEFORE the cycle begins, clean oven interior using a soapy sponge or plastic scrubber and a solution of detergent and hot water. Rinse and dry all areas thoroughly. **NOTE:** Do not rub the oven door gasket.

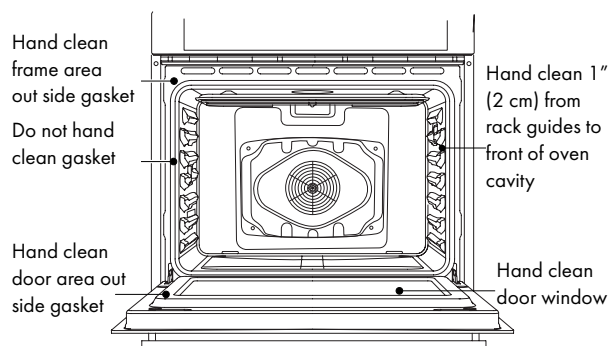

# MAINTENANCE AND CLEANING

## SELF-CLEAN CYCLE

A minimum 24-hour wait is recommended between cleaning cycles.

### TO SELF-CLEAN

Close the oven door.

1. Press 1 for upper oven or 2 for lower oven.
2. Press SELF CLEAN. "REMOVE RACKS" will appear in the selected oven text area of the display.
3. "2:00 3:00 3:30" will appear in the display.
4. Use the number keypad to select the clean level. Select 1-3.
5. If you want to delay the start of the self-cleaning cycle, press START TIME, and then set a time, by pressing the number keypad. The oven door will remain locked if the oven cavity is above a safe temperature and will unlock when the oven cavity has cooled.
6. Press START. After the door is locked, "SELF CLEAN" will scroll in the selected text area until the clean cycle is finished. When the Self-clean Cycle Ends: "COMPLETE" appears in the display and the oven door unlocks. **NOTE:** SELF CLEAN can be canceled by pressing STOP/CLEAR. The oven door will remain locked if the oven cavity is above a safe temperature and will unlock when the oven cavity has cooled.
7. Once the oven has completely cooled, remove ash with a damp cloth. **NOTE:** To avoid breaking the glass, do not apply a cool, damp cloth to the inner door glass before it has cooled completely.

## OVEN DOOR REMOVAL

For normal oven use, there is no need to remove the oven door. However, should it become necessary to remove the door, follow the instructions in this section.

### IMPORTANT:

- Make sure oven is cool and that power to the oven has been turned off before removing the door.
- The oven door is heavy and fragile, and the door front is glass. To avoid oven door glass breakage, use both hands, and grasp only the sides of the oven door to remove. Do not grasp the handle.
- Be sure both levers are securely in place before removing the door.
- Do not force door open or closed.



# MAINTENANCE AND CLEANING

## REMOVE THE OVEN DOOR

1. Open the door completely.
2. Flip up the hinge latch on each side.

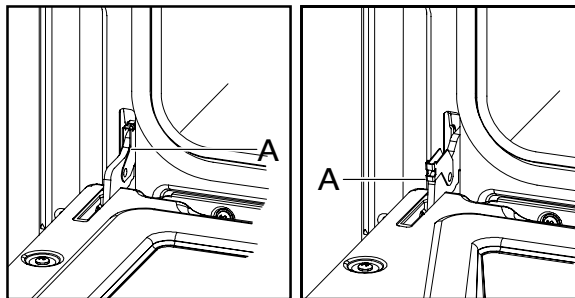

A. Hinge bracket

3. Holding the door firmly, close the oven door completely.
4. Grasping both sides lift up on the oven door while pushing it closed, and then pull it away from the door frame.
5. Place the door in a protected location.

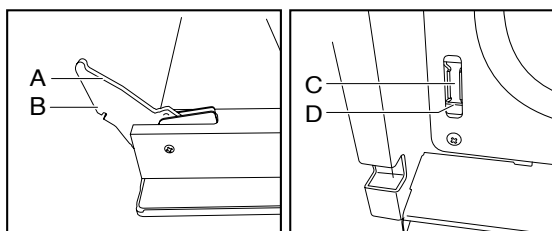

A. Upper arm  
B. Recess

C. Slots  
D. Lip

## TO REPLACE THE OVEN DOOR

1. Holding the door firmly, insert the upper arms of both hinges into the slots. The recesses must hook on the lips.
2. Open the oven door. **NOTE:** You should hear a “click” sound when the door is correctly in place.
3. Move the hinge latch on each side back into the locked position.
4. Open and close the door to test that it operates freely. If it does not, repeat the door removal and replacement process.
5. Close and open the door slowly to assure that it is correctly and securely in place.

# MAINTENANCE AND CLEANING

## REPLACING AN OVEN LIGHT

- Make sure the oven and lights are cool and power to the oven has been turned off before replacing the light bulb(s).
- The lenses must be in place when using the oven. The lenses serve to protect the light bulb from breaking.
- The lenses are made of glass. Handle carefully to avoid breakage.
- Failure to do so could result in death, electric shock, cuts or burns.
- The oven light is a standard 25 watt (G9) appliance bulb.



Before replacing the bulb make sure the oven is cool and the controls are turned off.

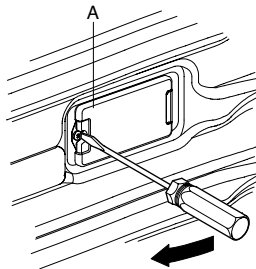

A. Light cover

1. Disconnect power at the main power supply (fuse or breaker box).
2. Using a Phillips-head screwdriver, remove the screw, and then remove the cover.
3. Remove the burned out bulb from the socket. **NOTE:** To avoid damage or decreasing the life of the new bulb, do not touch bulb with bare fingers. Wear cotton gloves or use a tissue when replacing the light bulb.
4. Replace the bulb, and then replace the bulb cover.
5. Reconnect power at the main power supply (fuse or breaker box).

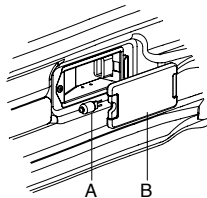

A. Light bulb  
B. Light cover

# TROUBLESHOOTING



ZLINE Customer Service is available at 1-614-777-5004.

| POSSIBLE FAULT                                      | POSSIBLE FAULT                            |
|---|---|
| Food browns unevenly                                | Oven not preheated                        |
|   | Aluminum foil on oven rack or oven bottom |
|   | Baking utensil too large for recipe       |
|   | Pans touching each other or oven walls    |
| Food too brown on bottom                            | Oven not preheated                        |
|   | Using glass, dull or darkened metal pans  |
|   | Incorrect rack position                   |
|   | Pans touching each other or oven walls    |
| Food is dry or has shrunk excessively               | Oven temperature too high                 |
|   | Baking time too long                      |
|   | Oven door opened                          |
|   | Pan size too large                        |
| Pie crusts do not brown on bottom or crust is soggy | Oven temperature too low                  |
|   | Oven not preheated                        |
|   | Oven door opened frequently               |
|   | Tightly sealed with aluminum foil         |
|   | Pan size too small                        |
| Cakes pale, flat and may not be done inside         | Oven temperature too low                  |
|   | Incorrect baking time                     |
|   | Cake tested too soon                      |
|   | Oven door opened too often                |
|   | Pan size too small                        |

# TROUBLESHOOTING

| FAULT  | POSSIBLE CAUSE                                    | TROUBLESHOOTING  |
|--|---|--|
| F03 or F04 Error appears in the display window.        | A problem with latch mechanism occurred.          | Turn off power at the main power supply (fuse or breaker box), wait a few seconds and turn it back on again. The oven should run a latch auto-test. If condition persists, note the code number and call an authorized service center. |
| Other F_ Error appears in the display window.          |   | Turn off power at the main power supply (fuse or breaker box), wait a few seconds and turn it back on again. If condition persists, note the code number and call an authorized service center.  |
| The oven display does not illuminate.                  |   | Turn off power at the main power supply (fuse or breaker box). Turn breaker back on. If condition persists, call an authorized service center.   |
| Cooling fan continues to run after oven is turned off. | The oven components have not cooled sufficiently. | The fan turns off automatically when the electronic components have cooled sufficiently.   |

# TROUBLESHOOTING

| FAULT   | POSSIBLE CAUSE                         | TROUBLESHOOTING   |
|---|--|---|
| Oven door is locked and will not release, even after cooling. |  | Turn the oven off at the circuit breaker and wait a few seconds. Turn breaker back on. The oven should reset itself and will be operable. |
| Oven is not heating.  | No power going to the oven.            | Turn on power at the main power supply (fuse or circuit breaker box). If condition persists, call a qualified electrician.                |
|   | Oven Mode or Temperature not selected. | Press cooking option on keypad to select the oven mode and temperature.   |
| Oven is not cooking evenly.                                   | Oven rack is not in correct position.  | Refer to cook charts starting on page 39 for recommended rack position.   |
|   | Convection Bake Mode                   | Always reduce recipe temperature by 25°F when baking with Convection Bake mode.   |
| Oven light is not working properly.                           | Light bulb is loose or burned out.     | Turn the oven off at the circuit breaker and wait a few seconds. Turn breaker back on. The oven should reset itself and will be operable. |

# TROUBLESHOOTING

| FAULT                               | POSSIBLE CAUSE                                       | TROUBLESHOOTING   |
|-------------------------------------|--|---|
| Oven light stays on.                | Oven door does not close completely.                 | Check for obstruction in oven door. Check to see if hinge is bent or door switch is broken.   |
| Cannot remove lens cover on light.  | Lens cover is dirty.                                 | There may be a soil build-up around the lens cover. Wipe lens cover area with a clean dry towel prior to attempting to remove the lens cover. |
| Oven will not Self- Clean properly. | Oven was still warm when Cleaning mode was selected. | Allow the oven to cool before running Self-Cleaning.  |
|                                     | Oven is heavily soiled.                              | Always wipe out loose soils or heavy spillover before running Self-Cleaning. See Oven Finishes/Cleaning Method on page 48.                    |
|                                     |  | If oven is badly soiled, set oven for a 4-hour Self-Cleaning.   |

# TROUBLESHOOTING

| FAULT                                     | POSSIBLE CAUSE                               | TROUBLESHOOTING   |
|---|--|---|
| Clock and timer are not working properly. | No power going to the oven.                  | Turn the oven off at the circuit breaker and wait a few seconds. Turn breaker back on. The oven should reset itself and will be operable.                     |
|   | Clock or Timer not set correctly.            | See Timer on page 18 and Clock on page 20.  |
| Excessive moisture                        | Oven was not properly preheated.             | When using bake mode, preheat the oven first. Convection Bake and Convection Roast will eliminate any moisture in oven (one of the advantages of convection). |
| Porcelain chips                           | Oven racks removed and replaced incorrectly. | When oven racks are removed and replaced, always tilt racks upward and do not force them to avoid chipping the porcelain.                                     |

# TROUBLESHOOTING

| POSSIBLE FAULT                         | POSSIBLE FAULT                         |
|--|--|
| Cakes high in middle with crack on top | Oven temperature too high              |
|  | Baking time too long                   |
|  | Pans touching each other or oven walls |
|  | Incorrect rack position                |
|  | Pan size too small                     |
| Pie crust edges too brown              | Oven temperature too high              |
|  | Edges of crust too thin                |



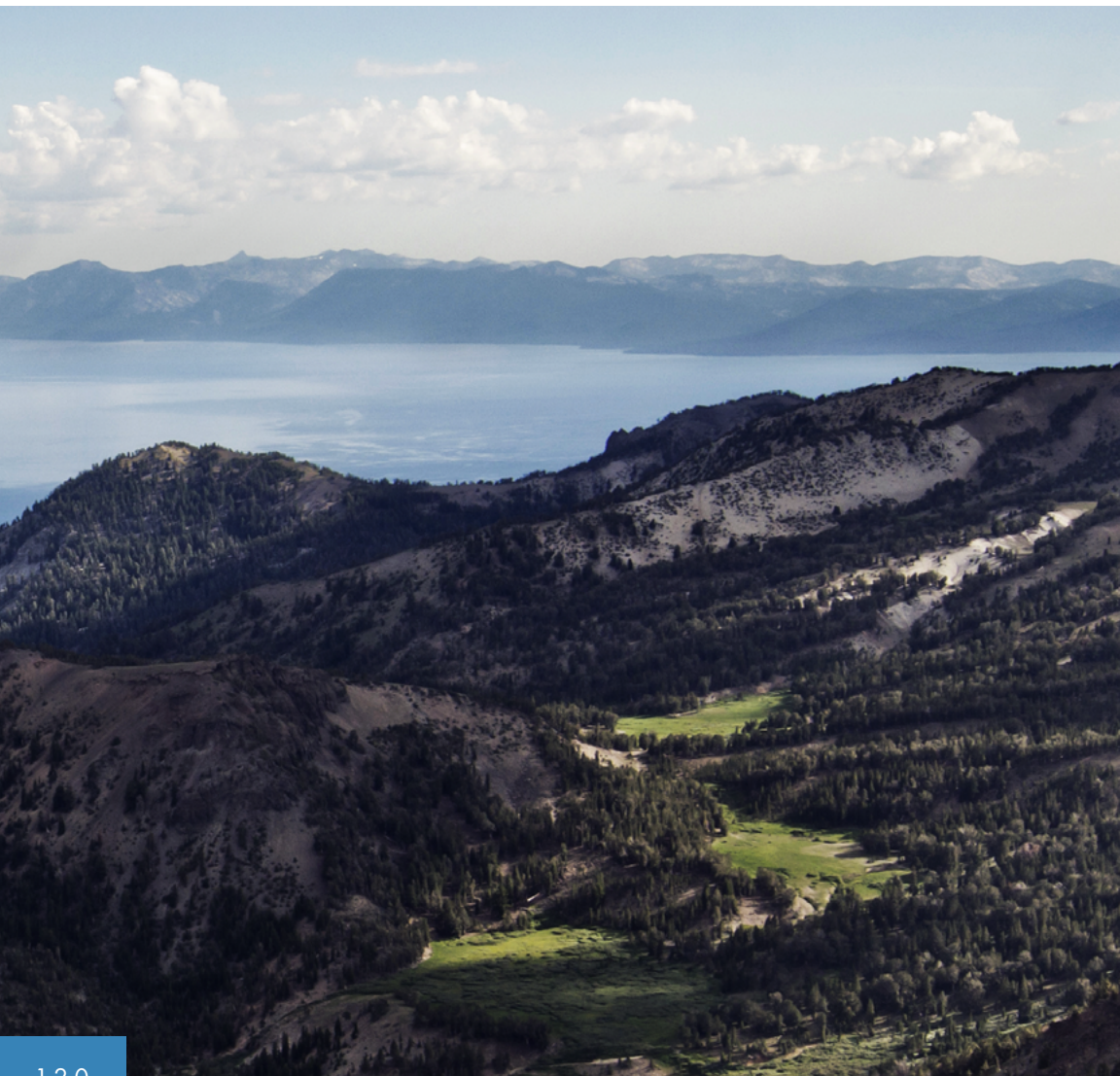

1.2.0



ATTAINABLE **LUXURY**<sup>®</sup>

[www.zlinekitchen.com](http://www.zlinekitchen.com)  
1-614-777-5004