

Materials

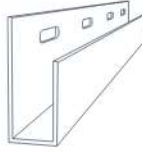

Trusscore Wall&CeilingBoard
Panels



1/2" J Trim



H-Channel Snap-In Kit
Optional



Screws
1-1/4" Pan/Truss head

Material quantities will vary by project. For more trim options and configurations, visit trusscore.com/trims.

Tools required



Drill/Screw Gun



Level



Utility Knife



Safety Glasses



Tin Snips



Putty Knife



Ladder and/or
Scaffolding



Face Mask



Radial Arm Saw or
Handheld Power Saw



Tape Measure

What to know before starting

- Acclimatize panels to room temperature for at least 24 hours before installation
- Panels are best cut with a masonry blade, or a fine-tooth blade installed in the reverse direction. Use tin snips to cut trim and avoid fully closing the blades while cutting for best results
- Don't overtighten screws to allow for expansion and contraction of panels and maintain a 1/4" clearance between the ends of each panel and any adjacent trims. Panels should be able to slide up and down slightly once fastened
- The final panel of a wall or ceiling area may need to be trimmed (ripped) to fit
- Use a putty knife to help panel edges fit into any adjacent trim

Step 1: Ceiling

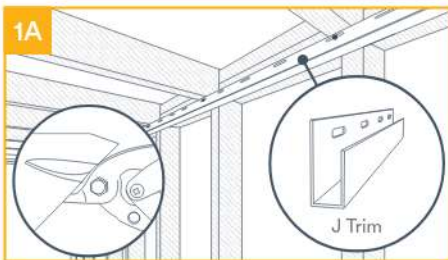

Trim out the ceiling area. Cut your trim to length and install around the entire ceiling perimeter.

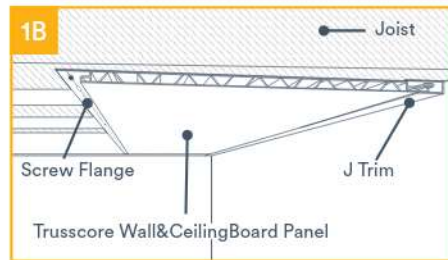

Install panels perpendicular to the joist direction. Start by sliding the tongue edge of the first panel into the J Trim, leaving the screw flange exposed. Fasten the panel through the screw flange at each joist.



Continue installing the remaining Wall&CeilingBoard panels. If your ceiling dimensions exceed the longest available panel length of 20', use H Channel Snap-In Trim to join panel sections.

Step 2: Walls

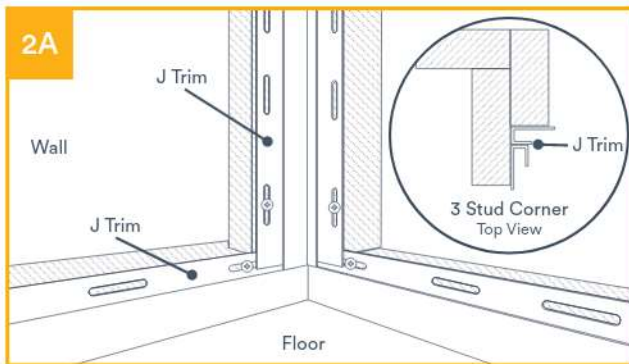

If using J Trim for wall corners, install J Trim before any panels. Install wall panel trim in the corners of the room, at the top and base of each wall, and around any openings like windows or doors.

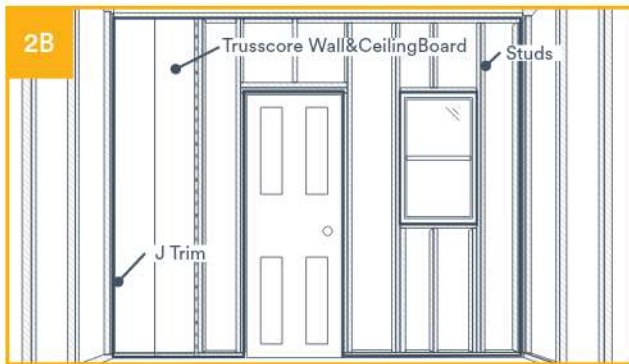

Depending on the dimensions and design of your space, panels may need to be cut to length. Vertically insert the first panel into the top, bottom, and corner trim pieces, then use a level to ensure straightness and fasten to the stud every 16"-24".

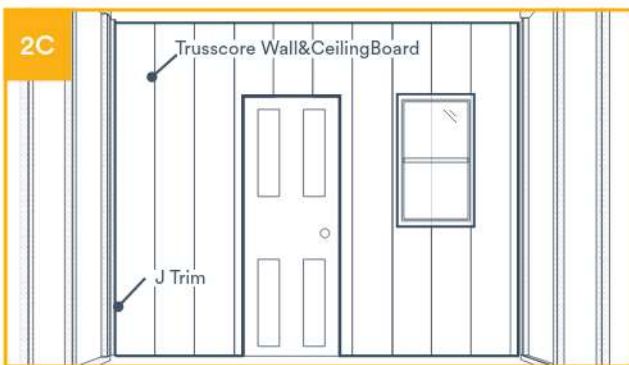

Continue installing the remaining Wall&CeilingBoard panels across all desired areas, cutting/notching panels for window or door openings as appropriate. Fasten panels through the screw flange along each stud.

Step 3: Integrating Trusscore SlatWall (recommended)

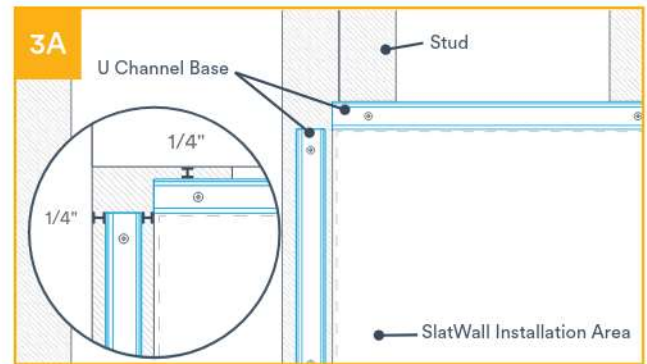

Installing Trusscore SlatWall too? Great — let's back up a step. Before installing Wall&CeilingBoard on your walls plan out and mark your intended SlatWall installation area, leaving adequate space to install the U Channel Base on the top and sides, which will accept the H Channel Snap-In Trim at the end.

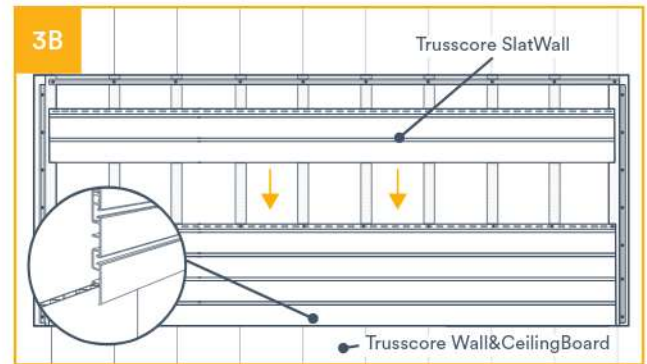

Once the installation area is marked, and Wall&CeilingBoard panels are installed, cut SlatWall panels to size and install one at a time, starting from the bottom. Properly interlocked panels will have next-to-invisible seams. Fasten each panel through the screw flange into each stud prior to installing the next panel*.

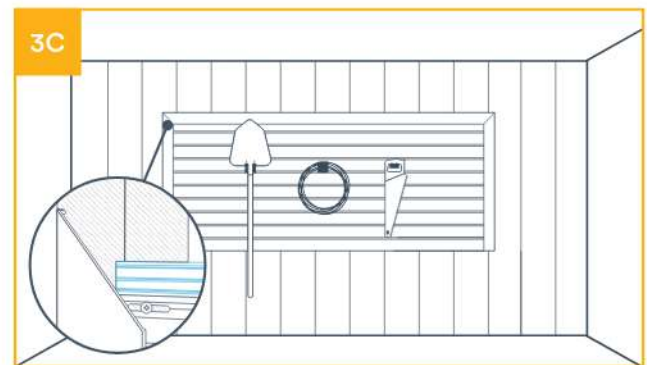

Once all panels are installed, cut H Channel Trim to size, and snap it into the U Channel Base to cover seams at the sides and top for a smooth transition from SlatWall to Wall&CeilingBoard. Add your choice of standard 3" SlatWall accessories and enjoy your newly organized, fully upgraded space!

* Trusscore SlatWall panels must start/finish fastened to a stud and must be fastened to studs every 16" on-center (maximum span) in order to support up to 75 lbs per square foot. Installation of blocking may be required for greater stud intervals.

We're here to help. Reach out to us for additional support.
hello@trusscore.com | 1.888.418.4679

Copyright © 2021 Trusscore Inc. Trusscore is a trademark of Trusscore Inc. All other trademarks are the property of their respective owners. Specifications are subject to change. T-QS101-001 11/2021

Looking for more?
trusscore.com/install