

USE AND CARE GUIDE

LED TV TAPE LIGHT

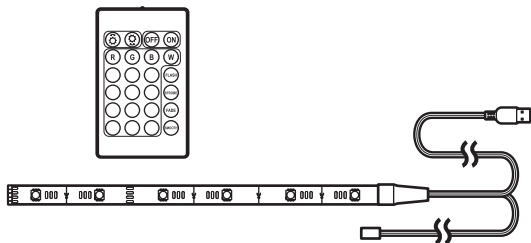

Questions, problems, missing parts? Before returning to the store, call Commercial Electric Customer Service
8 a.m. - 7 p.m., EST, Monday - Friday
9 a.m. - 6 p.m., EST, Saturday

1-877-527-0313

HOMEDEPOT.COM

Table of Contents

Safety Information	3	Operation	8
Pre-Installation	4	Care and Cleaning	9
Installation	5	Battery Safety	9

Safety Information

Read and understand this entire manual before you attempt to install or operate this product.

- This tape light is intended for indoor use only.
- This tape light is not intended for commercial use.
- Do not expose the tape light to excessive heat or moisture.



WARNING: Changes or modifications to this unit not expressly approved by the party responsible for compliance could void the user's authority to operate the equipment. Do not damage or crimp the cable. Do not allow the cable to come into contact with sharp objects.



CAUTION: Do not look directly at the tape light when it is illuminated. Eye damage could occur.

NOTE: This equipment has been tested and found to comply with the limits for a Class B digital device, pursuant to Part 15 of the FCC Rules. These limits are designed to provide reasonable protection against harmful interference in a residential installation. This equipment generates, uses and can radiate radio frequency energy and, if not installed and used in accordance with the instructions, may cause harmful interference to radio communications. However, there is no guarantee that interference will not occur in a particular installation. If this equipment does cause harmful interference to radio or television reception, which can be determined by turning the equipment off and on, the user is encouraged to try to correct the interference by one or more of the following measures:

- Reorient or relocate the receiving antenna.
- Increase the separation between the equipment and receiver.
- Connect the equipment into an outlet on a circuit different from that to which the receiver is connected.
- Consult the dealer or an experienced radio/TV technician for help.

NOTICE: This device complies with Part 15 of the FCC Rules. Operation is subject to the following two conditions: (1) this device may not cause harmful interference, and (2) this device must accept any interference received, including interference that may cause undesired operation.

Pre-Installation

PLANNING INSTALLATION

Inspect the product for damage. If any part appears damaged, do not install this product. Contact the Customer Service Team at 1-877-527-0313.

PACKAGE CONTENTS

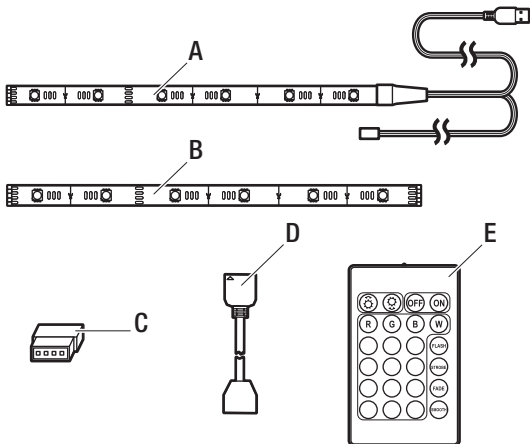

Part	Description	Quantity
A	Tape light with USB socket and infrared sensor	1
B	Tape light (extension)	1
C	Connector	1
D	Connector cable	1
E	Remote control	1

Installation

1 Preparing the tape light

- (optional) Shorten the tape light (A) or (B) to the desired length by cutting along the white, dotted lines. If using both tape lights, only tape light (B) can be cut.

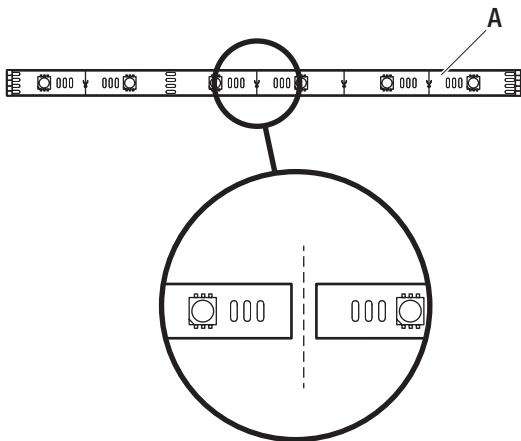

2 Installing the tape light

- Ensure that the mounting location is even, clean, and dry.
- Ensure that the tape light (A) can reach the USB port on the TV.
- Remove the protective film from the back of the tape light (A).
- Press the tape light (A) to the mounting surface and hold in place for a few seconds.
- Repeat for the other tape light (B).

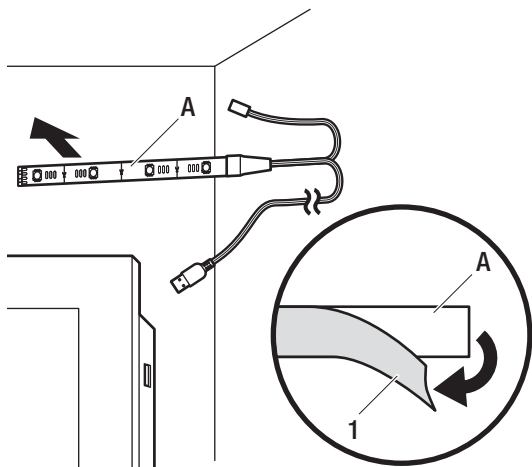

Installation (continued)

3 Connecting the tape light

- Connect the tape lights (A) and (B) using the connector (C) and connector cable (D) matching the markings below.

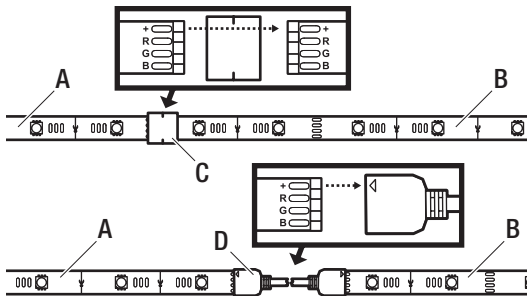





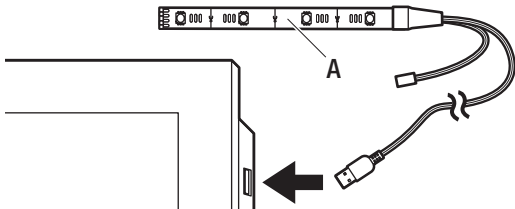



4 Connecting the power

- Connect the tape light (A) to a USB port on the TV.



Operation

Button	Description
 A circular button with the word "ON" in the center.	Switch on the tape light.
 A circular button with the word "OFF" in the center.	Switch off the tape light.
 A circular button with a sun icon and two upward-pointing arrows above it.	<ul style="list-style-type: none"><input type="checkbox"/> Increase the brightness in single color mode.<input type="checkbox"/> Increase the speed in flash, strobe, fade, and smooth modes.
 A circular button with a sun icon and two downward-pointing arrows below it.	<ul style="list-style-type: none"><input type="checkbox"/> Decrease the brightness in single color mode.<input type="checkbox"/> Decrease the speed in flash, strobe, fade, and smooth modes.
 A circular button with the word "FLASH" in the center.	Flash mode: each color flashes quickly.
 A circular button with the word "STROBE" in the center.	Strobe mode: the color changes every 3 seconds.
 A circular button with the word "FADE" in the center.	Fade mode: the color changes slowly.
 A circular button with the word "SMOOTH" in the center.	Smooth mode: the color changes slightly faster than in fade mode.
 Four small circular buttons labeled "R", "G", "B", and "W" in a row.	Select from 16 colors, with adjustable brightness.

Care and Cleaning

Use a soft, dry cloth to clean the tape light. Do not use alcohol-based cleaners, as this may damage the acrylic surface.

Battery Safety

- Swallowing the batteries may lead to serious injury or death. If swallowed go straight to a medical emergency room.
- Clean batteries and the battery contacts before inserting if necessary with a clean, dry cloth.
- Always purchase the correct size and grade of batteries that are most suitable for the intended use.
- Ensure the batteries may cause battery leakage and cause damage to the device or other harmful.
- Remove batteries when they are not used for an extended period of time.
- Remove used batteries promptly.
- Keep batteries out of children's reach.
- Do not charge, dismantle, throw into fire, or short circuit the batteries.
- If a battery has leaked, avoid contact with skin, eyes, and mucous membranes. Promptly rinse any affected area with water and seek medical assistance.
- Do not mix old and new batteries.
- Always use the same type of batteries. Do not mix alkaline, standard (Carbon-Zinc), or rechargeable (Nickel Cadmium) or (Nickel Metal Hydride) batteries.





Questions, problems, missing parts? Before returning to the store,
call Commercial Electric Customer Service
8 a.m.-7 p.m., EST, Monday-Friday, 9 a.m.-6p.m., EST, Saturday

1-877-527-0313

HOMEDEPOT.COM

Retain this manual for future use.