

SERVICE INSTRUCTIONS

1. This Cooker has no user serviceable parts. Do NOT attempt to repair or adjust any electrical or mechanical functions on this Cooker. Doing so may cause injuries and void the warranty. Any servicing beyond that described in the CARE AND CLEANING section should be performed by an Authorized Service Representative only. See Warranty Section.
2. If you need to exchange the Cooker, please return it in its original carton, with a sales receipt, to the store where you purchased it. If you are returning the Cooker more than 30 days after the date of purchase, please see the enclosed Warranty.
3. If you have any questions or comments regarding this Cooker's operation or believe any repair is necessary, please call our Consumer Service Department at 1-800-323-9519 or visit our website at www.crockpot.com.

1 YEAR LIMITED WARRANTY

Sunbeam Products, Inc. or if in Canada, Newell Brands Canada ULC (collectively "Sunbeam") warrants that for a period of one year from the date of purchase, this product will be free from defects in material and workmanship. Sunbeam, at its option, will repair or replace this product or any component of the product found to be defective during the warranty period. Replacement will be made with a new or remanufactured product or component. If the product is no longer available, replacement may be made with a similar product of equal or greater value. This is your exclusive warranty. Do NOT attempt to repair or adjust any electrical or mechanical functions on this product. Doing so will void this warranty.

This warranty is valid for the original retail purchaser from the date of initial retail purchase and is not transferable. Keep the original sales receipt. Proof of purchase is required to obtain warranty performance. Sunbeam dealers, service centers, or retail stores selling Sunbeam products do not have the right to alter, modify or any way change the terms and conditions of this warranty.

This warranty does not cover normal wear of parts or damage resulting from any of the following: negligent use or misuse of the product, use on improper voltage or current, use contrary to the operating instructions, disassembly, repair or alteration by anyone other than Sunbeam or an authorized Sunbeam service center. Further, the warranty does not cover: Acts of God, such as fire, flood, hurricanes and tornadoes.

What are the limits on Sunbeam's Liability?

Sunbeam shall not be liable for any incidental or consequential damages caused by the breach of any express, implied or statutory warranty or condition.

Except to the extent prohibited by applicable law, any implied warranty or condition of merchantability or fitness for a particular purpose is limited in duration to the duration of the above warranty.

Sunbeam disclaims all other warranties, conditions or representations, express, implied, statutory or otherwise.

Sunbeam shall not be liable for any damages of any kind resulting from the purchase, use or misuse of, or inability to use the product including incidental, special, consequential or similar damages or loss of profits, or for any breach of contract, fundamental or otherwise, or for any claim brought against purchaser by any other party.

Some provinces, states or jurisdictions do not allow the exclusion or limitation of incidental or consequential damages or limitations on how long an implied warranty lasts, so the above limitations or exclusion may not apply to you.

This warranty gives you specific legal rights, and you may also have other rights that vary from province to province, state to state or jurisdiction to jurisdiction.

How To Obtain Warranty Service

In the U.S.A.

If you have any question regarding this warranty or would like to obtain warranty service, please call 1-800-323-9519 and a convenient service center address will be provided to you.

In Canada

If you have any question regarding this warranty or would like to obtain warranty service, please call 1-800-323-9519 and a convenient service center address will be provided to you.

In the U.S.A., this warranty is offered by Sunbeam Products, Inc. Boca Raton, Florida 33431. In Canada, this warranty is offered by Newell Brands Canada ULC, located at 20B Hereford Street, Brampton, Ontario L6Y 0M1. If you have any other problem or claim in connection with this product, please write to Consumer Service Department.

PLEASE DO NOT RETURN THIS PRODUCT TO ANY OF THESE ADDRESSES OR TO THE PLACE OF PURCHASE.

To register your product, please visit us online at www.crockpot.com.

© 2019 Sunbeam Products, Inc. All rights reserved. Distributed by Sunbeam Products, Inc. Boca Raton, Florida 33431.

Printed in China

6Qt Crock-Pot Express Easy Release Pressure Cooker

P.N.199492
GCDS-CRP-SL



CROCK·POT®

EXPRESS

6 Qt Easy Release Pressure Cooker



Owner's Manual

Read and Keep These Instructions

www.crockpot.com or follow us:  

IMPORTANT SAFEGUARDS

When using electrical appliances, basic safety precautions should always be followed to reduce the risk of fire, electric shock, and/or injury to persons including the following:

1. Read all instructions before using this product.
2. This appliance cooks under pressure when using pressure cooking functions. Improper use may result in scalding injury. Make certain unit is properly closed before operating. See Operating Instructions.
3. This appliance generates heat during use. Do not touch hot surfaces. Use handles or knobs.
4. Do not fill the unit over maximum fill line at 2/3 full. When cooking foods that expand during cooking such as rice, beans, potatoes or dried vegetables, do not fill the unit beyond the recommended level at 1/2 full. Over filling may cause a risk of clogging the valves and developing excess pressure. Follow all cooking and recipe instructions.
5. Always check the pressure release devices for clogging before use. Clean as necessary.
6. Place the Cooker so that the Steam Release Valve is positioned away from the body.
7.  Never place any part of the body, including face, hands, and arms over the Steam Release Valve. Steam can result in serious burns.
CAUTION: When in the "Seal"  position, please note steam may still be released from the Steam Release Valve on the Lid to regulate the proper amount of pressure for cooking. Always keep face

- and hands clear of Steam Release Valve.
8. Do not operate the Cooker without food or liquid in the Cooking Pot.
9. To prevent risk of injury due to excessive pressure, replace Lid Sealing Gasket only as recommended by the manufacturer. See Care and Cleaning instructions.
10. Do not use the Lid to carry the Cooker.
11. Do not move or cover the Cooker while it is in operation.
- 12. After pressure cooking, do not open the Cooker until the unit has cooled, all internal pressure has been released, and the Bobber Valve has dropped completely. If the Lid is difficult to remove, this indicates that the cooker is still pressurized - do not force it open. Any pressure in the Cooker can be hazardous. See RELEASING PRESSURE instructions (pages 20-21).**
13. Be careful when lifting and removing Lid after cooking. Always tilt the Lid away from you as steam is hot and can result in serious burns. Never place face over the Cooker.
14. Do not use this Cooker for pressure frying with oil.
15. To protect against electric shock, do not place or immerse cord, plugs, or appliance in water or other liquid.
16. Do not use the Cooking Pot for food storage or place in the freezer.
17. To prevent damage to the Cooker do not use alkaline cleaning agents when cleaning. Use a soft cloth and a mild detergent.

18. This appliance is **NOT** to be used by children or by persons with reduced physical, sensory, or mental capabilities.
19. Close supervision is necessary when any appliance is used near children. Children should not play with the appliance.
20. If Power Cord is detachable, always plug cord fully into the Cooker first, then plug cord into the wall outlet.
21. Unplug from outlet when not in use, before putting on or taking off parts and before cleaning. Allow to cool before putting on or taking off parts, and before cleaning. To disconnect, ensure that the Cooker is OFF, then unplug Power Cord from outlet. Do not disconnect by pulling on cord.
22. Do not operate any appliance with a damaged cord or plug or after the appliance malfunctions, or has been damaged in any manner. Do not attempt to replace or splice a damaged cord. Return appliance to the manufacturer (see warranty) for examination, repair or adjustment.
23. Do not let Power Cord hang over edge of table or counter or come into contact with hot surfaces.
24. Extreme caution must be used when moving an appliance containing hot liquids.
25. The use of accessory attachments not recommended by the appliance manufacturer may cause injuries.
26. Do not use outdoors or for commercial purposes.
27. Do not place on or near wet surfaces, or heat sources such as a hot gas or electric burner, or in a heated oven.
28. Do not use appliance for other than intended use. Misuse can cause injuries. This appliance is not intended for deep frying foods.
29. **CAUTION:** To protect against electrical shock and product damage, do not cook directly in the Heating Base. Cook only in the removable Cooking Pot provided.
30. **WARNING:** Spilled food can cause serious burns. Keep appliance and cord away from children. Never drape cord over edge of counter, never use outlet below counter, and never use with an extension cord.
31. Do not plug in or turn on the Cooker without having the Cooking Pot inside the Cooker.
32. Intended for household countertop use only. Keep 6 inches (15.2 cm) clear from the wall and on all sides. Always use appliance on a dry, stable, level surface.
33. Be aware that certain foods, such as applesauce, cranberries, pearl barley, oatmeal or other cereals, split peas, noodles, macaroni, rhubarb, or spaghetti can foam, froth, and sputter, and clog the pressure release device (Steam Release Valve). Recipes using these items must be followed carefully to avoid problems.

**SAVE THESE INSTRUCTIONS
HOUSEHOLD USE ONLY**

NORTH AMERICAN MODELS WITH POLARIZED PLUGS:

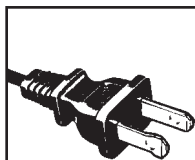

POLARIZED PLUG

This appliance has a polarized plug (one blade is wider than the other). To reduce the risk of electric shock, this plug is intended to fit into a polarized outlet only one way. If the plug does not fit fully into the outlet, reverse the plug. If it still does not fit, contact a qualified electrician. Do not attempt to modify the plug in any way. If the plug fits loosely into the AC outlet or if the AC outlet feels warm do not use that outlet.

POWER CORD INSTRUCTIONS:

A short Power Cord is used to reduce the risk resulting from it being grabbed by children, becoming entangled in, or tripping over a longer cord.

NOTICES:

1. Some countertop and table surfaces are not designed to withstand the prolonged heat generated by certain appliances. Do not set the heated Cooker on a finished wood table. We recommend placing a hot pad or trivet under your Cooker to prevent possible damage to the surface.
2. During initial use of this appliance, some slight smoke and/or odor may be detected. This is normal with many heating appliances and will not recur after a few uses.
3. Please use caution when placing your Cooking Pot on a ceramic or smooth glass cook top stove, countertop, table or other surface. It may scratch some surfaces if caution is not used. Always place heat resistant protective padding under the Cooking Pot before setting on a table, countertop or other surface.

6 QT CROCK-POT® EXPRESS COMPONENTS

Figure 1

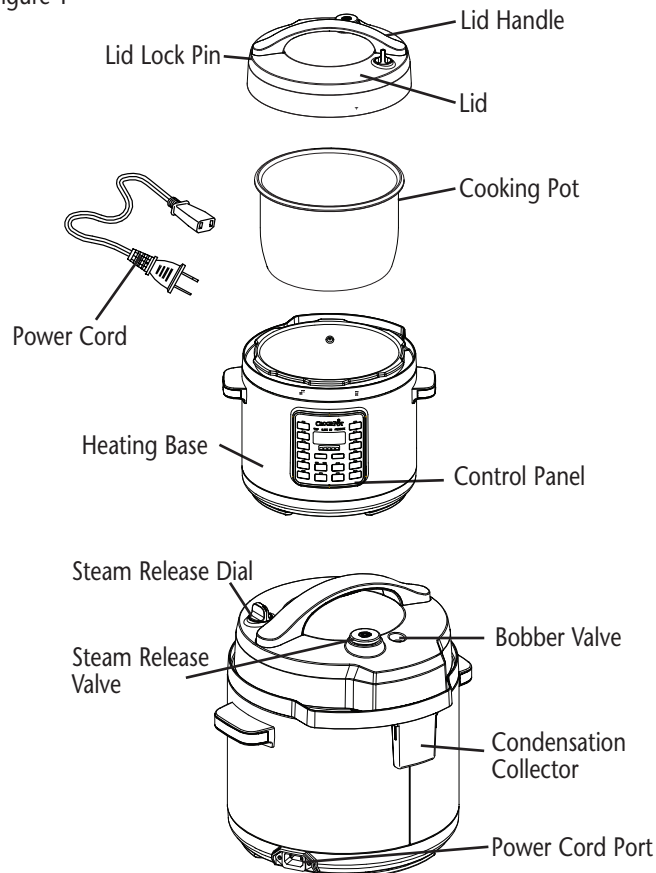

6 QT CROCK-POT® EXPRESS COMPONENTS

CONTROL PANEL

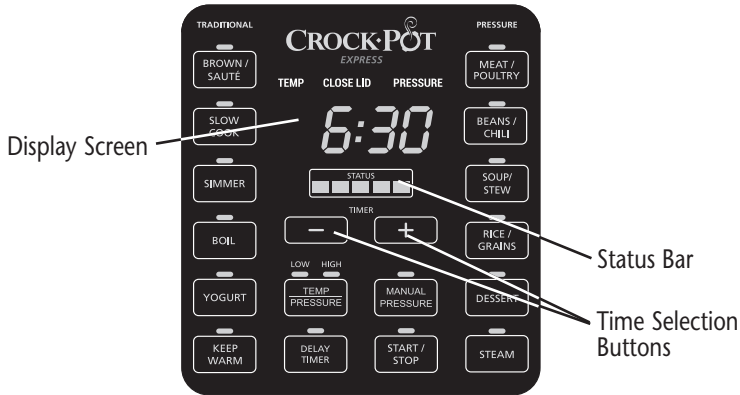

UNDERSIDE OF Lid

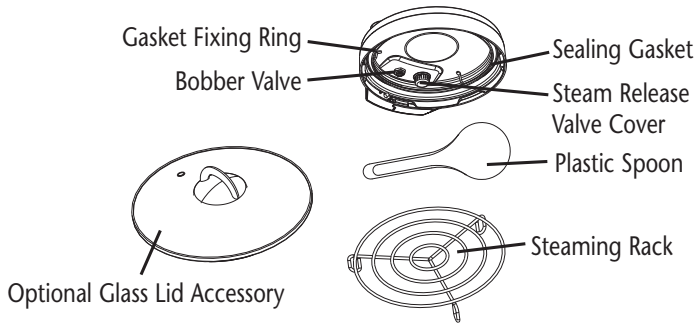

HOW TO USE YOUR CROCK-POT® EXPRESS

Getting started:

Remove all packaging, paper, and cardboard (including any located between the Cooking Pot and Heating Base). Read and save the literature and be sure to read the service and warranty information.

Visit the Crock-Pot® website at www.crockpot.com for additional information, hints, tips and recipes or call 1-800-323-9519.

Assembly:

- Place Cooking Pot into the Heating Base
- Place Lid upon Cooker and align ▼ with ■. To lock, twist counterclockwise, aligning ▼ with ■. To unlock, twist Lid clockwise and align ▼ with ■.

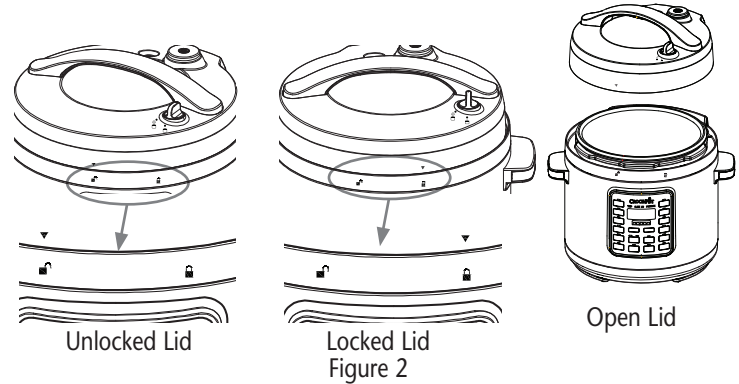

A NOTE ABOUT PRESSURE COOKING

Pressure cookers generate steam in order to build pressure. Liquid is needed to create steam. So in order for your Crock-Pot® Express to build enough pressure to cook your meal, there needs to be enough liquid in the pot to boil and generate steam. One cup or 8 oz of liquid (it can be water, chicken broth, etc.) is usually enough liquid to successfully build pressure. If your recipe is too thick or doesn't have enough liquid in it, then you will receive an E6 Notification Code during the cooking cycle.

GETTING TO KNOW YOUR CROCK-POT® EXPRESS

1. Remove the Lid by turning clockwise to unlock, aligning ▼ with ■. Remove the Sealing Gasket from the Lid and wash the gasket and the Lid in warm soapy water. Dry the Sealing Gasket and Lid thoroughly before reattaching the Sealing Gasket to the Lid. Ensure the Sealing Gasket is smoothly and securely in place in the Gasket Fixing Ring. If the Sealing Gasket is not in the correct position the Lid will not be able to form a seal and will not be able to gain pressure.
2. Remove the Cooking Pot and the Condensation Collector and wash in warm, soapy water. Dry thoroughly before replacing back in the Cooker.

The Crock-Pot® Express Easy Release Pressure Cooker has been designed with safety in mind and has various safety measures.

1. Pressure will not build if the Lid is not shut correctly and has not sealed.
2. Ensure the Lid is in the locked position and the ▼ is aligned with ■.
3. Pressure will not build if the Steam Release Dial has not been switched to the "Seal"  position.

CAUTION: When in the "Seal"  position, please note steam may still be released from the Steam Release Valve on the Lid to regulate the proper amount of pressure for cooking. Always keep face and hands clear of Steam Release Valve.

GETTING TO KNOW YOUR CROCK-POT® EXPRESS (CONT.)

4. Over filling may cause a risk of clogging the valves and developing excess pressure.
5. The gasket and the valves can be removed for cleaning (see pages 36-38).
6. Once the pressure increases, the Lid should not be opened. Safety sensors ensure the pressure remains within the set range. Never force the Lid open.
7. The Steam Release Dial is located on the front of the Lid, designed to keep the hand away from the Steam Release Valve when releasing pressure. The Steam Release Valve is designed to be loose-fitting for proper operation. See RELEASING PRESSURE instructions on pages 20-21.
8. The pressure cooking functions require liquid to work. If the inside of the Cooking Pot does not have enough liquid, a notification will appear on the Display Screen. See NOTIFICATION CODES chart on pages 41-42.
9. At the end of cooking, the Lid should not be unlocked until all the pressure is released, and the Bobber Valve has dropped completely. This can be done using the Natural Pressure Release Method or Quick Pressure Release Method, explained on pages 20-21.
10. The Time Selection Buttons (+ and -) are used to set the cooking time. To advance slowly, simply press the + or - button and release. To advance quickly, press and hold the + or - button. If you have passed the desired time, simply press the opposite button to return to the desired time.

NOTE: The timer can be selected for all programs and can be changed at any time during cooking by pressing **START/STOP** and selecting a new function.

11. The **TEMP/PRESSURE** button is used to select desired cooking temperature or pressure (HIGH or LOW). The Display Screen will illuminate TEMP or PRESSURE, depending on which setting is being adjusted.
12. The temperature may only be adjusted on the **SLOW COOK, YOGURT, BOIL, SIMMER,** and **BROWN/SAUTÉ**

GETTING TO KNOW YOUR CROCK-POT® EXPRESS (CONT.)

functions (see the Cooking Guide on page 25 for available adjustments).

- Each pre-set pressure cooking function automatically selects the optimum pressure for that selection, but it can be manually selected with the **TEMP/PRESSURE** button (see the Cooking Guide on page 25 for available adjustments).
- The **START/STOP** button starts and stops a cooking function to another after cooking has begun.
- The Display Screen shows how much longer the food needs to cook from the selected time in hours and minutes once the Cooker is preheated. While the Cooker is preheating, the display screen will show, "HEAT".
- The Status Bar tracks the pressurization progress when using a Pressure function, and the preheat progress when using a Traditional function before cooking begins.

GETTING STARTED

(NOTE: The Cooker beeps as each button is pressed.)

- Add desired ingredients to Cooking Pot. Place Lid on top of Cooker and align ▼ with □. To lock, twist counterclockwise, aligning ▼ with □.
- Turn the Steam Release Dial to the "Seal"  position if pressure cooking. The Steam Release Dial should be open when using the **SLOW COOK** and **YOGURT** functions. Do not place the Lid on when using **BROWN/SAUTÉ, SIMMER, or BOIL**.
- Plug provided Power Cord into the Power Cord Port of the Cooker.
- Plug Power Cord into a wall power outlet.
- Select the cooking function you would like to use.
- The **START/STOP** button and the time on the screen will flash.
- Select the desired cook time by using the + and - buttons. Select the desired temperature or pressure

GETTING STARTED (CONT.)

using the **TEMP/PRESSURE** button, if applicable (see the Cooking Guide chart on page 25 for time and temperature recommendations).

- Press the **START/STOP** button. For pressure cooking functions, the word "HEAT" will appear on the Display Screen during pressurization time. For **BROWN/SAUTÉ, BOIL & SIMMER**, the word "HEAT" will appear on the Display Screen during preheating time. Pressurization and preheat progress can be easily tracked with the Status Bar under the Display Screen. Once the Cooker is pressurized or preheated, the selected cooking time will appear on the Display Screen.
Note: For pressure cooking functions, 13-15 minutes is the approximate average pressurization time. If food content is larger or very cold, pressurization time may take slightly longer.
- This Cooker allows you to delay the start of your cooking so that cooking finishes when you need it. See page 14 for instructions on the **DELAY TIMER** function.
- After the set cooking time has elapsed, the Cooker will beep again and will automatically switch to the **KEEP WARM** setting. The Display Screen will then change from the cook time to a new timer that will count up to 4:00 (4 hours) or until you press the **START/STOP** button. After 4 hours in the **KEEP WARM** setting, the Cooker will turn off.
- To end a cooking function at any time, press the **START/STOP** button.
- When finished, unplug the Cooker and wait for it to cool completely before attempting to clean.
CAUTION: The Cooking Pot and Heating Base will get very hot while using this Cooker. Do not touch hot surfaces. Always use pot holders or oven-mitts when using this Cooker. Always lift the Lid by tilting away from you to avoid the steam.

USING THE MANUAL SETTING WHILE PRESSURE COOKING

If you have a pressure recipe that requires a manual setting — or if you simply want to pressure cook using your own pressure setting and cook time — then select **MANUAL PRESSURE** and adjust the pressure and cook time as desired. See the Cooking Guide on page 25 to find the possible time and pressure adjustments.

HOW TO USE THE TIME DELAY

This Cooker allows you to delay the start of your cooking so that cooking finishes when you need it.

Note: The **DELAY TIMER** function is not available on the **BROWN/SAUTÉ, KEEP WARM, BOIL, SIMMER** or **YOGURT** settings.

Note: Do not use the **DELAY TIMER** function when the recipe has perishable ingredients such as meat, fish, eggs, or dairy, as these may spoil.

1. Adjust the Cooker settings using the instructions on pages 17-34.
2. After setting the cooking time, press the **DELAY TIMER** button. The **DELAY TIMER** and **START/STOP** buttons will flash, and “0:30” will flash on the Display Screen, to indicate the Cooker is being programmed on the delay setting.
3. Press the + and - buttons until you reach the number of hours and minutes you want the cooking process to be delayed (i.e. set the amount of time you wish to delay the cooking cycle). The maximum delay is 4 hours (4:00).
4. Press **START/STOP** button to begin the delay feature. The timer and **DELAY TIMER** button will stop flashing, while the **START/STOP** button will continue flashing. This will indicate that the Cooker has been set on

HOW TO USE THE TIME DELAY (CONT.)

the **DELAY TIMER** setting. The Display Screen will countdown the delay time until 0:00 is reached. When 0:00 is reached, the **DELAY TIMER** light will turn off and the **START/STOP** light will stop flashing to show that time delay has finished. The word “HEAt” will appear on the display screen until the Cooker is fully pressurized. When the selected pressure has been reached, the timer will start counting down.

Example:

It’s 4pm and you want to have a soup cooked and ready in 2 hours’ time for dinner at 6pm. You want to set the Cooker now so you are free to do other things.

The pre-set function (if unchanged) will cook for 30 minutes at HIGH pressure. Time to gain pressure varies according to altitude and water temperature, but let’s assume it takes 15 minutes to gain pressure. Therefore total time is 45 minutes. To have the soup ready by 6pm, you will need to delay the start of your cooking by approximately 1 hour and 15 minutes.

1. Press **SOUP/STEW**
2. The Display Screen will flash “0:30”
3. Press the **DELAY TIMER** button and set for “1:15”
4. Press **START/STOP**

COOKING POT MARKINGS

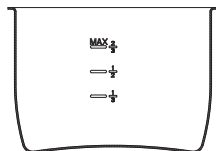

Figure 3

Inside the removable Cooking Pot are markings to guide the fill level of the Cooking Pot. The word MAX indicates the maximum fill line.

The 1/3, 1/2, and 2/3 markings are handy guides to use in your recipes.

CAUTION: Never load the Cooking Pot above the maximum fill level line marked MAX on the inside of the Cooking Pot.

Foods that expand during cooking (e.g., rice, beans, dried vegetables, potatoes, carrots, etc.) should never go above the 1/2 mark.

Note: The Cooker cannot pressure cook without liquid. Ensure a minimum of 8oz of liquid is used inside the removable Cooking Pot.

PRESSURE COOKING

Pressure cooking is an ideal way to create quick, flavorful meals. Pressure cooking is a method of cooking food in liquid (water, stock, wine, etc.) in a sealed Cooking Pot. The sealed Cooker retains steam and builds pressure, raising the temperature of the liquid inside the pot above boiling point. The increased temperature of the liquid and the steam results in reduced cooking times.

HIGH Pressure Setting is 6.5 - 10 PSI (45 - 70 kPa). It is suitable for a wide range of foods.

LOW Pressure Setting is 3.3 - 6.5 PSI (23 - 45 kPa). It is more suited to delicate foods like chicken fillet, fish and some vegetables.

KEEP WARM Setting: When cooking time is completed, the Cooker automatically switches to the **KEEP WARM** setting to prevent overcooking and to keep your cooked food warm until serving - perfect for busy families, those on-the-go and those who need flexible meal times. This setting is not hot enough to cook and should only be used to keep cooked food warm before serving.

Ideal Meals to Pressure Cook: Soups, stocks, casseroles, sauces (e.g., pasta sauces), meat, rice, firm vegetables (beetroot, potatoes) and desserts (e.g., pudding).

Capacity: Never fill the Cooking Pot above the MAX line. Foods that expand during cooking should never go above the 1/2 mark. The Cooker cannot pressure cook without liquid. Ensure a minimum of 8oz of liquid is used inside the removable Cooking Pot.

CAUTION: Never use the Quick Pressure Release Method when cooking foods high in liquid content, such as casseroles, stocks and soups. See **RELEASING PRESSURE** instructions on pages 20-21.

USING THE PRESSURE COOKING FUNCTIONS

Place the Cooker on a flat, level surface.

Place Cooking Pot inside Heating Base. Plug the Cooker into a wall outlet. The Cooker will beep, and the Display Screen will illuminate with four dashes (- - - -).

1. Place your food and liquid inside the removable Cooking Pot.
2. Place the Lid onto the Cooker and align ▼ with ▣. To lock, rotate counterclockwise to the **LOCKED** 🔒 position.
3. Rotate the Steam Release Dial to the "Seal" 🗄️ position.
4. Select the desired cooking function.
5. Adjust the cooking time and pressure if necessary.
Note: See the Cooking Guide on page 25 to find the possible time and pressure adjustments.
6. Once you have made the desired adjustments, if any, press **START/STOP**.
7. The Cooker needs to gain pressure before pressure cooking can begin. When the Cooker is gaining pressure, "HEAT" will appear on the Display Screen and the time will not count down. The Status Bar will illuminate to track the pressurization progress before cooking will begin. The amount of time the Cooker takes to gain pressure varies according to altitude and water temperature, but average pressurization time is 13-15 minutes. When pressure has been reached, "HEAT" will disappear on the Display Screen, and the time will begin to count down.
8. After the set cooking time has elapsed, the Cooker will beep and will automatically switch to the **KEEP WARM** setting. The Display Screen will therefore change from the cook time to a new timer that will count up to 4:00 (4 hours) or until you press the **START/STOP** button. After 4 hours in the **KEEP WARM** setting, the Cooker will go into stand-by mode, and the Display Screen will illuminate with four dashes (- - - -).

USING THE PRESSURE COOKER FUNCTIONS (CONT.)

TIPS:

1. The pressure cooking settings are in the Cooking Guide table on page 25.
2. If the Lid is not shut correctly or if the Steam Release Dial is not in the "Seal" 🗄️ position, the Cooker cannot gain pressure and a NOTIFICATION message will appear in the Display Screen. Ensure that the Sealing Gasket is placed evenly in the Lid. See the NOTIFICATION CODES chart on pages 41-42.
3. It is common for some steam to release through the Bobber Valve during the cooking cycle. This is part of normal operation of the unit.

Note: The Cooker cannot pressure cook without liquid. Ensure a minimum of 8oz of liquid is used inside the removable Cooking Pot.

CAUTION: During cooking, steam will build up in the Cooker, so when lifting the Lid use a kitchen glove or mitt to protect your hand.

BOBBER VALVE

When Bobber Valve is in the “UP” position, DO NOT attempt to open the Lid, as the Cooker is still under pressure. When the Bobber Valve is in the “DOWN” position, the pressure has released (see Figure 4).

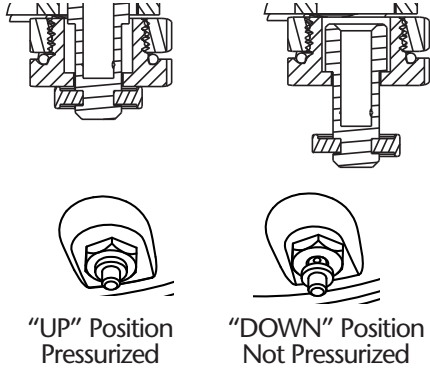

Figure 4

RELEASING PRESSURE AT THE END OF COOKING

A. **Natural Pressure Release Method:** After cooking cycle is complete, let Cooker naturally release pressure through the Bobber Valve. Unit will gradually cool down on its own. Wait at least 10 minutes after cooking has completed, and then rotate the Steam Release Dial to the “Release” position (see Figure 5). Do not place any part of your hand or body over the Steam Release Valve, as steam is very hot and can scald skin. The pressure has been released when steam is no longer escaping from the valve, the Bobber Valve has dropped completely, and the Lid opens freely with minimal force. This can take up to 10-20 minutes. Never force the Lid open.

RELEASING PRESSURE AT THE END OF COOKING (CONT.)

B. **Quick Pressure Release Method:** Rotate the Steam Release Dial located at the front of the Lid to the “Release” position (see Figure 5). Steam will release rapidly from the Steam Release Valve on the back of the Lid. Do not place any part of your hand or body on or over the Steam Release Valve, as steam is very hot and can scald skin.

CAUTION: Never use this method when cooking foods high in liquid content such as casseroles, beans, stews, stocks and soups. Never use this method when cooking rice, as rice tends to be very delicate. The pressure has been released when steam is no longer escaping from the valve, the Bobber Valve has dropped and the Lid opens freely with minimal force. This can take up to 10-20 minutes. Never force the Lid open.

CAUTION:

1. Do not force the Lid to open. If the Bobber Valve has dropped completely and the Lid does not open easily, this means that the Cooker is still under pressure.
2. During cooking, steam will build up in the Cooker, so when lifting the Lid use a kitchen glove or mitt to protect your hand.
3. To avoid suction when removing or securing the Lid, turn the Steam Release Dial to the “Release” position.

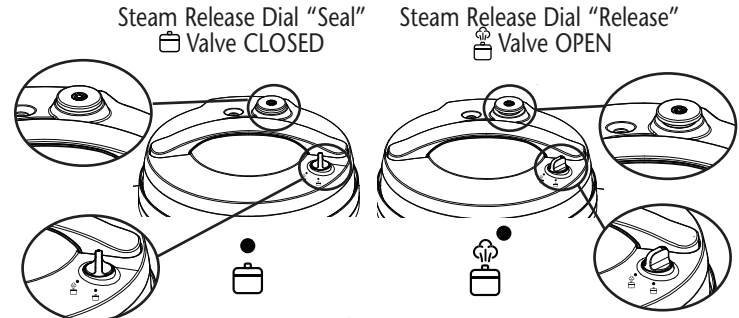

Figure 5

USING THE LID AND STEAM RELEASE DIAL

FUNCTION	PRESSURE COOK	Lid REQUIRED	STEAM RELEASE DIAL POSITION
MANUAL PRESSURE	Yes	Yes	Seal
MEAT/POULTRY	Yes	Yes	Seal
BEANS/CHILI	Yes	Yes	Seal
RICE/GRAINS	Yes	Yes	Seal
YOGURT	No	Yes (in some steps)	Release
DESSERT	Yes	Yes	Seal
SOUP/STEW	Yes	Yes	Seal
SLOW COOK	No	Yes	Release
STEAM	Yes	Yes	Seal
BROWN/SAUTÉ	No	No	Do Not Use Lid
BOIL	No	No	Do Not Use Lid
SIMMER	No	No	Do Not Use Lid

USING THE GLASS Lid

The optional Glass Lid accessory can be used instead of the standard Crock-Pot® Express Lid on all non-pressure cooking functions such as **SLOW COOK**, **BROWN/SAUTÉ**, **BOIL**, **SIMMER**, **YOGURT**, and **KEEP WARM**.

SLOW COOKING

LOW Setting: This is suitable for simmering and slow cooking. Recommended cooking time in LOW is for 8 or more hours.

HIGH Setting: This is for faster cooking. Recommended cooking times in HIGH are from 4 to 6 hours.

KEEP WARM Setting: When cooking time is completed, the Cooker automatically switches to the **KEEP WARM** setting to prevent overcooking and to keep your cooked food warm until serving - perfect for busy families, those on-the-go and those who need flexible meal times. This setting is not hot enough to cook and should only be used to keep cooked food warm before serving.

Note: When slow cooking, the ideal fill level for your ingredients is between the 1/2 and 2/3 marks. Never fill the Cooking Pot above the MAX line.

USING THE SLOW COOK FUNCTION

The **SLOW COOK** function does not use pressure in the cooking process, but some pressure can build inside the unit during cooking. When using this function, ensure the Steam Release Dial is in the "Release"  position. This function will cook similarly to standard slow cookers, using lower temperatures and longer cooking times to achieve tender, flavorful meals.

Place the Cooker on a flat, level surface.

Place Cooking Pot inside Heating Base. Plug the Cooker into a wall outlet. The Cooker will beep, and the Display Screen will illuminate with four dashes (----).

1. Place your food and liquid inside the removable Cooking Pot.

USING THE SLOW COOK FUNCTION (CONT.)

- Place the Lid onto the Cooker and align ▼ with ■. To lock, rotate counterclockwise to the **LOCKED** position.
- Rotate the Steam Release Dial to the "Release" position.
Note: Although this setting will not use pressure in the cooking process, some pressure can build inside the unit during cooking. This is why it's important to keep the Steam Release Dial in the "Release" position.
- Press the **SLOW COOK** button and adjust the time and temperature as needed.
Note: See the Cooking Guide on page 25 to find the possible time and temperature adjustments.
- Press **START/STOP**. The time will begin to count down.
- After the set cooking time has elapsed, the Cooker will beep and will automatically switch to the **KEEP WARM** setting. The Display Screen will therefore change from the cook time to a new timer that will count up to 4:00 (4 hours) or until you press the **START/STOP** button. After 4 hours in the **KEEP WARM** setting, the Cooker will turn off.

Note: As the **SLOW COOK** function does not cook under pressure, you can remove the Lid during cooking to check your slow cooking progress. Only lift the Lid if necessary. Since slow cooking uses lower temperatures to cook, the Cooker will not recover lost heat very quickly, which may impact cooking times.

TIP: The **SLOW COOK** settings are in the Cooking Guide on page 25.

CAUTION: During slow cooking, steam may build up in the Cooker, so when lifting the Lid use a kitchen glove or mitt to protect your hand.

COOKING GUIDE

Cooking Function	Default Setting	Pressure Adjustments	Temperature Adjustments	Cook Time Range
BROWN/SAUTÉ	High temp / 30 minutes	N/A	Low-High	5 minutes – 30 minutes
SLOW COOK	High temp / 4 hours	N/A	Low-High	30 minutes – 20 hours
SIMMER	Low temp / 15 minutes	N/A	Low-High	5 minutes - 4 hours
BOIL	Low temp / 15 minutes	N/A	Low-High	5 minutes - 4 hours
YOGURT	Low temp / 8 hours	N/A	Low-High	Low: 6 hours - 12 hours High: N/A
KEEP WARM	Warm temp / 4 hours	N/A	Warm	30 minutes – 4 hours
MANUAL PRESSURE	High Pressure / 30 minutes	Low-High	N/A	1 minute - 4 hours
MEAT/POULTRY	High pressure / 35 minutes	Low-High	N/A	15 minutes – 2 hours
BEANS/CHILI	High pressure / 20 minutes	Low-High	N/A	1 minute - 4 hours
SOUP/STEW	High pressure / 30 minutes	Low-High	N/A	5 minutes – 2 hours
RICE/GRAINS	Low pressure / 12 minutes	Low-High	N/A	3 minutes – 30 minutes
DESSERT	Low pressure / 10 minutes	Low-High	N/A	5 minutes – 2 hours
STEAM	High pressure / 10 minutes	Low-High	N/A	1 minute – 1 hour

STEAMING

The **STEAM** function is perfect for gently steaming fish and vegetables. It is pre-programmed to use the HIGH pressure cooking setting. When steaming, use the Steaming Rack.



Capacity: When the Cooker is used with the **STEAM** function, the maximum capacity of liquid should be just under the rack wires, so that the liquid is not touching the food.

Note: The unit cannot pressure cook without liquid. Ensure a minimum of 8oz of liquid is used inside the removable Cooking Pot.

USING THE STEAM FUNCTION

Place the Cooker on a flat, level surface.

Place Cooking Pot inside Heating Base. Plug the Cooker into a wall outlet. The Cooker will beep, and the Display Screen will illuminate with four dashes (- - - -).

1. Add 8oz of water to the bottom of the removable Cooking Pot and insert the Steaming Rack. Ensure water is just under the wires of the rack so that food is not touching water.
2. Place your food on the Steaming Rack.
3. Place the Lid on and lock by rotating counterclockwise to the **LOCKED**  position.
4. Rotate the Steam Release Dial to "Seal"  position.
5. Press the **STEAM** button and adjust the time and pressure as needed.

USING THE STEAM FUNCTION (CONT.)

Note: See the Cooking Guide on page 25 to find the possible time and pressure adjustments.

6. Once you have made the desired adjustments, if any, press **START/STOP**.
7. The Cooker needs to gain pressure before pressure cooking can begin. When the Cooker is gaining pressure, "HEAT" will appear on the Display Screen and the time will not count down. The Status Bar will illuminate to track the pressurization progress before cooking will begin. When pressure has been reached, "HEAT" will disappear on the Display Screen, and the time will begin to count down.
8. After the set cooking time has elapsed, the Cooker will beep and will automatically switch to the **KEEP WARM** setting. The Display Screen will therefore change from the cook time to a new timer that will count up to 4:00 (4 hours) or until you press the **START/STOP** button. After 4 hours in the **KEEP WARM** setting, the Cooker will turn off.

TIP: See the Steaming Chart on page 28.

CAUTION: During cooking, steam will build up in the Cooker, so when lifting the Lid use a kitchen glove or mitt to protect your hand.

STEAMING CHART

Food	Amount	Amount of water	Pre-prep	Cooking Time
Vegetables				
Asparagus	1 lb	2 cups	Whole/trimmed	4 - 5 minutes
Broccoli	1 bunch	2 cups	2-inch florets	2 - 3 minutes
Baby carrots or 1 ½ inch pieces	1 lb	2 cups	Peeled and trimmed	2 - 3 minutes
Cauliflower	1 medium head	2 cups	2-inch pieces	2 - 3 minutes
Corn on the cob	4	2 cups	6-inches	3 - 5 minutes
Green beans	1 lb	2 cups	Whole/trimmed	2 - 3 minutes
Snow peas	1 lb	2 cups	Whole/trimmed	1 - 3 minutes
White or Yukon Gold potatoes	12 ounces	2 cups	Quartered	7 - 9 minutes
Sweet Potatoes	12 ounces	2 cups	Cut in 1 ½-inch pieces	7 - 9 minutes
Yellow squash or zucchini	1 lb	2 cups	Thickly sliced	6 - 8 minutes
Poultry				
Eggs	8	2 cups	Whole in shell	6 - 9 minutes
Fish				
Loyster tails	Large	2 cups	In shell	3 - 4 minutes
Large Shrimp	1 lb	2 cups	Peeled and deveined	1 - 3 minutes
Salmon	1 lb	2 cups	Cut in serving size pieces	3 - 5 minutes

BROWN/SAUTÉ

The setting **BROWN/SAUTÉ** does not cook under pressure. They work similarly to standard cooking, requiring dry heat, and therefore do not need the Lid. Place the Cooker on a flat, level surface.

Do not use the Lid with this function.

BROWN

The **BROWN (BROWN/SAUTÉ on LOW)** function is designed to brown (SAUTÉ) meats for casseroles and soups. Browning meat prior to pressure cooking and slow cooking not only gives your food great color, but it also seals in the flavorful juices and keeps the meat tender.

SAUTÉ

The **SAUTÉ (BROWN/SAUTÉ on LOW)** function is designed to sauté onions and mirepoix (mixture of chopped onion, carrot, and celery), among many other foods, often used in pressure cooker and slow cooker recipes. Sautéing onions allows caramelization which contributes to the flavor and color in the end dish.

USING THE BROWN/SAUTÉ FUNCTIONS

Place Cooking Pot inside Heating Base. Plug the Cooker into a wall outlet. The Cooker will beep, and the Display Screen will illuminate with four dashes (- - - -).

1. Select the **BROWN/SAUTÉ** function and adjust the time and temperature if necessary, using the + and - buttons.
2. Press **START/STOP**.
3. When the Cooker is pre-heating, "HEAT" will appear on the Display Screen. The Status Bar will illuminate to track the preheat progress before cooking will begin. When the temperature has been reached, the timer will start counting down. Using plastic tongs, carefully add your food to the hot pot.

Capacity: When the Cooker is used to brown or sauté it may be best to cook in batches to ensure the food is evenly cooked.

RICE COOKING

When cooking rice, use the **RICE/GRAINS** function. This is suitable for all types of rice, including white and/or brown rice.

The **RICE/GRAINS** function cooks under pressure for faster cooking.

Capacity: Since rice expands during cooking, do not fill Cooking Pot above the 1/2 mark when pressure cooking rice.

USING THE RICE/GRAINS FUNCTION

Place the Cooker on a flat, level surface.

Place Cooking Pot inside Heating Base. Plug the Cooker into a wall outlet. The Cooker will beep, and the Display Screen will illuminate with four dashes (- - - -).

1. Measure the desired quantity of rice.
Note: 1 cup uncooked white rice = 2 cups of cooked white rice (approximately). 1 cup uncooked brown rice = 2 cups cooked brown rice (approximately).
2. Place the measured rice in a strainer and wash rice thoroughly under cold water. Wash until the water runs clear. This removes excess starch which helps to achieve fluffier rice, and prevents rice grains sticking to the Cooking Pot. Rinsing the rice reduces the build-up of starchy water and bubbles that sometimes form around the Valve Cover and Lid, which can cause spitting from the Steam Release Valve.
3. Ensure the Cooking Pot is clean and dry before placing it inside the Heating Base.
4. Place the washed rice in the Cooking Pot. Add the quantity of water needed for your recipe (Standard ratio -- 1 cup of uncooked rice : 1.5 cups of water). Ensure that a minimum of 8oz of liquid is placed inside the removable Cooking Pot.
5. Place the Lid on and lock by rotating counterclockwise to the **LOCKED**  position.

USING THE RICE/GRAINS FUNCTION (CONT.)

6. Rotate the Steam Release Dial to the "Seal"  position.
7. Press the **RICE/GRAINS** button and adjust the time and pressure as needed.
Note: See the Cooking Guide on page 25 to find the possible time and pressure adjustments.
8. Once you have made the desired adjustments, if any, press **START/STOP**.
9. The Cooker needs to gain pressure before pressure cooking can begin. When the Cooker is gaining pressure, "HEAT" will appear on the Display Screen and the time will not count down. The Status Bar will illuminate to track the pressurization progress before cooking will begin. When pressure has been reached, "HEAT" will disappear on the Display Screen, and the time will begin to count down.
10. After the set cooking time has elapsed, the Cooker will beep and will automatically switch to the **KEEP WARM** setting. The Display Screen will therefore change from the cook time to a new timer that will count up to 4:00 (4 hours) or until you press the **START/STOP** button. After 4 hours in the **KEEP WARM** setting, the Cooker will turn off.

TIPS:

1. Do not keep rice in the pot for extended periods of time on the **KEEP WARM** setting, as the rice will become dry and the quality will deteriorate. Use the supplied plastic spoon to stir and serve the rice. Do not use metal utensils, as these may scratch the non-stick coating.

USING THE RICE/GRAINS FUNCTION (CONT.)

2. As rice grains can be delicate, at the end of cooking wait until the pressure releases naturally (see page 20). Do not use the Quick Pressure Release Method.
3. Standard ratio for cooking rice -- 1 cup of uncooked rice : 1.5 cups of water.

CAUTION: During cooking, steam will build up in the Cooker, so when lifting the Lid use a kitchen glove or mitt to protect your hand.

BOILING AND SIMMERING

The settings **BOIL** and **SIMMER** do not cook under pressure. They work similarly to standard cooking, requiring dry heat, and therefore do not need the Lid.

Do not use the Lid with these functions.

BOIL

The **BOIL** function is perfect for preparing meals like pasta and poached eggs.

LOW setting: This is suitable for boiling low volumes of food, such as from the bottom of the Cooking Pot to the 1/3 mark.

HIGH setting: This is suitable for boiling higher volumes of food, such as between the 1/3 to 1/2 marks. Do not fill the Cooking Pot above the 1/2 mark when using the **BOIL** function on HIGH temperature.

SIMMER

Thicken sauces and make gravies at the end of cooking using the **SIMMER** function.

LOW setting: This is suitable for simmering low volumes of food, such as between the bottom of the Cooking Pot and the 1/3 mark.

HIGH setting: This is suitable for simmering higher volumes of food, such as between the 1/3 and 1/2 marks in the Cooking Pot.

SIMMER (CONT.)

To thicken a dish at the end of cooking, use the **SIMMER** function and stir in a small amount of corn flour mixed with water. Allow to simmer, stirring until thickened.

USING THE BOIL AND SIMMER FUNCTIONS

Place the Cooker on a flat, level surface. **DO NOT USE THE LID WITH THE BOIL OR SIMMER FUNCTIONS.**

Place Cooking Pot inside Heating Base. Plug the Cooker into a wall outlet. The Cooker will beep, and the Display Screen will illuminate with four dashes (- - - -).

1. Place liquid inside the Cooking Pot prior to starting the **BOIL** and **SIMMER** functions.
2. Select either the **BOIL** or **SIMMER** function and adjust the temperature if necessary, using the + and - buttons.
3. Press **START/STOP**.
4. When the Cooker is pre-heating, "HEAt" will appear on the Display Screen. The Status Bar will illuminate to track preheat progress before cooking will begin. When the temperature has been reached, the timer will start counting down.

CAUTION: Never attempt to boil or simmer thick sauces. The **BOIL** and **SIMMER** functions are intended for liquids only. When boiling thick sauces, heat bubbles can form, become trapped and burst, and can result in serious burns.

TO CHANGE A SETTING

It's easy to switch functions during cooking. Press the **START/STOP** button and then select the new desired cooking function. A new timer will flash on the Display Screen, and the selected function will also flash. Select the desired time, pressure, and/or temperature. Press the **START/STOP** button and the new function will begin preheating.

To Change the Cooking Time:

You can change the cooking time before cooking begins by pressing the + and - buttons before pressing **START/STOP**. Press and release to change slowly. Press and hold to change time quickly. If you pass the desired temperature or time, press the opposite button.

To Change the Temperature and Pressure:

You can change the temperature or pressure on certain pre-set functions before cooking begins by pressing the **TEMP/PRESSURE** button before pressing **START/STOP**. The Display Screen will illuminate **TEMP** or **PRESSURE**, depending on which setting is being adjusted. The temperature may only be adjusted on the **SLOW COOK, YOGURT, BOIL, SIMMER,** and **BROWN/SAUTÉ** functions (see the Cooking Guide on page 25 for available adjustments).

CARE AND CLEANING

Cleaning should only be carried out when the the Crock-Pot® Express Easy Release Pressure Cooker is cool and unplugged. Allow the Cooker to completely cool before cleaning. Do not use the removable Cooking Pot on the stovetop, inside a microwave oven or inside an oven. Use the pot only inside the Crock-Pot® Express Easy Release Pressure Cooker Heating Base. Wash the Sealing Gasket and Lid by hand in warm, soapy water. Dry all parts thoroughly.

Cooking Pot:

When removing the Cooking Pot from the Heating Base, always use two hands and lift directly upward. Failure to do so may result in scratching the outside of the Cooking Pot (see Figure 6).

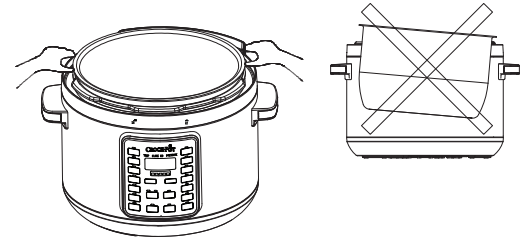

Figure 6

CARE AND CLEANING (CONT.)

If food sticks or burns to the surface of the Cooking Pot, then fill it with hot soapy water and let it soak before cleaning. Use a rubber or nylon spatula to remove stubborn residue. If scouring is necessary, use a non-abrasive cleaner and a nylon scouring pad or brush.

Although the Cooking Pot is dishwasher safe, we recommend hand-washing to preserve the non-stick coating.

If white spots form on the surface of the Cooking Pot, then soak it in a solution of vinegar or lemon juice and warm water for 30 minutes. Rinse and dry.

Note: Never use metal utensils or cleaning devices on the Cooking Pot, as this may result in scratching and damage to the non-stick coating.

Exterior

Wipe the exterior of the Heating Base with a damp cloth and polish dry. DO NOT use harsh abrasives, scourers or chemicals, as these will damage the surfaces. To prevent damage to the Cooker do not use alkaline cleaning agents when cleaning. Only use a soft cloth and mild detergent. Never immerse the Heating Base in water or any other liquid.

Condensation Collector

Empty any collected water from the Condensation Collector (see Figure 1) after each use. Wash in warm, soapy water.

Lid and Sealing Gasket

Always examine the gasket before each use. The silicone Sealing Gasket on the inside of your Cooker Lid (see Figure 1) may deteriorate over time. Remove Sealing Gasket for cleaning as needed. Hand-wash using warm, soapy water,

CARE AND CLEANING (CONT.)

dry thoroughly, and replace Sealing Gasket in Lid before use. Leave the Lid upturned for storage, as this will also extend the life of the gasket. Sealing Gasket may need to be replaced every 1 – 2 years depending on regular use. Contact Crock-Pot® customer service or visit www.crockpot.com to order replacement parts.

Steam Release Valve

Ensure the Steam Release Valve (see Figure 1) is clear from debris before you begin using the Cooker. Remove the valve (see Figure 7) and gently clean. Ensure it is completely dry before replacing.

Steam Release Valve Cover

The Steam Release Valve Cover is on the underside of the Lid (see Figure 8). Ensure it is clear from debris before you begin using the Cooker. To clean, carefully pull the cover off and clean using warm, soapy water. Press the cover back into its place after cleaning is complete.

Valve REMOVE

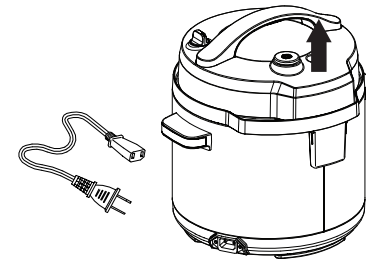

Figure 7

CARE AND CLEANING (CONT.)

UNDERSIDE OF Lid

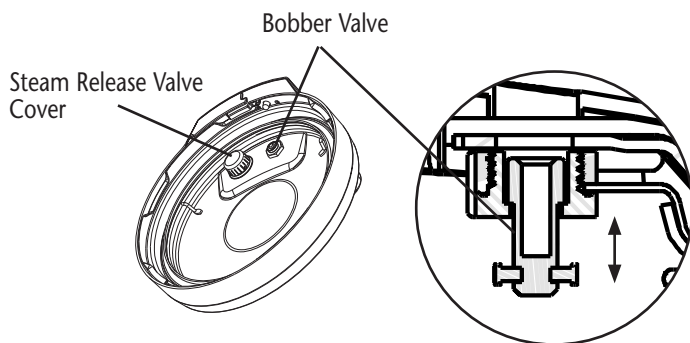

Figure 8

Bobber Valve

Gently press the valve up and down 2-3 times and ensure it is clear from debris before you begin using the Cooker.

Lid Lock Pin

Gently press the pin and ensure it is clear from debris before you begin using the Cooker.

Note:

1. Condensation may collect inside the Heating Base under the removable Cooking Pot. This is normal. Allow to cool, and then dry using kitchen cloth.
2. Always make sure that each component (pot, valves, gasket, etc.) is completely dry before you put back into the Cooker.





TROUBLESHOOTING

Subject	Question	Solution
Power	My Cooker will not turn on.	Make sure outlet is functioning properly.
		Check that the Cooker is plugged in.
		Call Customer Service at 1-800-323-9519.
Doneness of food	My food was undercooked.	Make sure you selected the proper cooking setting.
		Make sure the Lid is properly placed and locked, and that the Steam Release Dial is in "Seal"  position.
		Check the recipe to see that the proper pressure, temperature, and time selection were made.
		Be sure the power was not interrupted.
		Make sure the Cooking Pot has enough liquid to create desired steam and build pressure. Minimum of 8oz of liquid should be used when pressure cooking. Never fill over the "MAX" line.
	My food was overcooked.	Check that the proper pressure, temperature, and time were selected.
Programming	Can I set a time for the Brown/SAUTÉ or Sauté programs?	Because sautéing and SAUTÉing are functions that generally require your full attention this may not be necessary. However, if desired a time can be selected.





TROUBLESHOOTING (CONT.)

Subject	Question	Solution
	Can I change the cooking function, time or temperature once the food is cooking?	Yes, to change the cooking function, press START/STOP and select a new cooking function. Change the time and temperature as required for the food. Press START/STOP again. The time and temperature can be changed at any time.
Cooking	Can the Cooking Pot and Lid be used on top of the stove or in the oven?	The Cooking Pot and Lid are not oven safe. Neither can be used on the stove or in the oven.
	I stopped the cooking process and changed pressure settings, and now the Cooker is preheating again.	If a cooking cycle is stopped and a new one is started, the Cooker may display "HEAT" until the new pressure is achieved. Pressurization or preheat progress can be visually tracked on the Status Bar located under the Display Screen.
Steam	Steam is leaking out of the Cooker.	<ul style="list-style-type: none"> It is normal for a small amount of steam to come out of the Bobber Valve before the Cooker is pressurized. If steam is coming out from the perimeter of the Lid, the Lid has not been closed and locked completely.
Lid	I am having trouble removing the Lid.	There is a safety feature to keep the Lid from being removed while the Cooker is under pressure. Please make sure to de-pressurize the unit by rotating the Steam Release Dial into the "Release"  position. Refer to Releasing Pressure section for further instructions (pages 20-21).

NOTIFICATION CODES

Notification	Solution
"CLOSE Lid" blinking light	Ensure that the Lid is closed completely and in the LOCKED  position, aligning  with  .
Display "E1"	The Cooker will stop the cooking cycle. Unplug Cooker and contact customer service center at 1-800-323-9519.
Display "E2"	The Cooker will stop the cooking cycle. Unplug Cooker and contact customer service center at 1-800-323-9519.
Display "E3"	<p>If you receive this code while using one of the pressure cooking settings, then the Lid probably did not close or seal correctly. To resolve, follow the steps below:</p> <ol style="list-style-type: none"> Rotate the Steam Release Dial to the "Release"  position and wait for the unit to de-pressurize. Take off the Lid and look underneath to make sure the Sealing Gasket (large rubber ring) is properly secured to the underside of the Lid. If your recipe looks like it may need more liquid now that you have released some of the steam after removing the Lid, then add more, stir your ingredients, and reattach the Lid, making sure the Steam Release Dial is in the "Seal"  position. Unplug the unit for at least 5 seconds, and then re-plug it in and re-program your cook settings to begin cooking.

NOTIFICATION CODES (CONT.)

Notification	Solution
Display "E5"	This code appears when either the Lid or Steam Release Dial is being used incorrectly for a non-pressure cook setting. Please note that the Lid should never be used when using the BROWN/SAUTÉ , SIMMER or BOIL settings. When using the Lid during the SLOW COOK or YOGURT settings, the Steam Release Dial must be turned to the open or "Release"  position. If you receive the E5 Notification during any of these situations, then simply remove the Lid while using Brown/SAUTÉ, Sauté, Boil, and SIMMER , or correctly position Steam Release Dial to "Release"  while using SLOW COOK or YOGURT , and then unplug the unit for at least 5 seconds, re-plug it in and re-program your cook settings to begin cooking.
Display "E6"	If you receive this code while cooking, it means that the Crock-Pot® Express Easy Release Pressure Cooker was unable to generate enough steam to pressurize completely. To resolve, follow the steps below: <ol style="list-style-type: none"> 1. Make sure that the Steam Release Dial is turned to the closed or "Seal"  position. If it was not in the correct position, then rotate it to the correct position and jump to step 3 below. 2. If the Steam Release Dial was in the correct position, then turn it to the "Release"  position and wait for the unit to de-pressurize. Then remove the Lid and look underneath it to make sure the Sealing Gasket (large rubber ring) is properly secured to the underside of the Lid. 3. Add another cup of liquid (water, broth, etc) to the cooking pot, stir your ingredients, and reattach the Lid, making sure the Steam Release Dial is in the "Seal"  position. 4. Unplug the unit for at least 5 seconds, and then re-plug it in and re-program your cook settings to begin cooking.

HINTS AND TIPS

Hints and Tips to get the best use of your Crock-Pot® Express Easy Release Pressure Cooker: Go to the Crock-Pot® website at www.crockpot.com for additional recipes, hints, tips and much more.

With your Crock-Pot® Express Easy Release Pressure Cooker you can create a large variety of delicious meals, snacks and desserts. Various foods take different times to cook perfectly, so sometimes it may take some trial and error to get the cooking times right for you.

1. Please refer to your Crock-Pot® Express 6Qt Easy Release Owner's Manual when using your Cooker.
2. Never fill the Cooking Pot past the MAX line.
3. Do not leave Cooker plugged in when not in use.
4. Make sure Cooker is kept away from cabinets and walls when in use.
5. The Cooking Pot is designed to be used only in this Cooker. Do not use on stovetop, in microwave, or in oven.
6. The provided Steaming Rack is designed to be used in this Cooker. It should not damage the surface of the Cooking Pot. Do not stir ingredients while Steaming Rack is in Cooking Pot.
7. When removing the Lid, use a pot holder to grasp the Lid Handle and lift away from your body to allow steam to escape.
8. Always place a trivet or pot holder under the Cooking Pot if it is removed from the Heating Base.

HINTS AND TIPS FOR SLOW COOKING

- If you are slow cooking, you can use the **BROWN/SAUTÉ** function first to brown meats and sauté vegetables at the beginning. Browning meat prior to slow cooking not only gives your food great color, but it also seals in the flavorful juices and keeps the meat tender.
- When using the **SLOW COOK** function, make sure the Steam Release Dial is in the “Release”  position.
- When using the **SLOW COOK** function, the Cooker does not recover lost heat quickly, so only lift the Lid if necessary or if instructed to do so in the recipe. It’s a good idea to monitor your slow cooking results throughout the cooking cycle by quickly removing the Lid and checking, then quickly replacing the Lid. Different cuts and thickness of meats and vegetables can vary in required cook time.
- It is not uncommon for meat to cook faster than root vegetables. It is for this reason that we recommend chopping all vegetables to a similar small size. Meat can be cut into larger chunks because if it is cut too small, it will break up once cooked and tenderized.

HINTS AND TIPS FOR SLOW COOKING (CONT.)

- Slow Cooking reduces evaporation, resulting in the flavors and juices being maintained. Keep this in mind when creating your own recipes, as you may not require as much liquid as you would when using other cooking methods, such as pressure cooking.

Temperature	Temperature Suggestions	Recipes Ideas
High	Use this setting for recipes that require shorter cooking times, generally 4-6 hours.	Ideal for sauces, chili, potato dishes, cheese dishes, chicken wings and meatballs in sauce
Low	Use this setting for recipes that require longer cook times. This setting is used for recipes that usually require cooking for 8 or more hours. Perfect for less tender cuts of meats.	Ideal for less tender cuts of meat, braised meats, dried beans, soups and stews



NOTE



NOTE

