











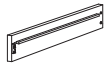
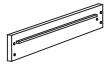







ASSEMBLY INSTRUCTIONS

1		Headboard	1 pc.
2		Headboard Wings	2 pcs.
3		Footboard	1 pc.
4		Top Side Rails	2 pcs.
5		Bottom Side Rails	2 pcs.
6		Footboard Legs	2 pcs.
7		Side Rail Support Legs	2 pcs.
8		Bed Slats	2 Sets (14pcs)
9		Center Legs	0 pcs. for Twin/Twin XL 4 pcs. for Full/Queen 8 pcs. for King/Cal King
10		Center Supports	0 pcs. for Twin/Twin XL 2 pcs. for Full/Queen 4 pcs. for King/Cal King
11		Headboard Legs	2 pcs.

A		65mm Allen Key	1 pc.
B		JCBC Bolts (M6x30mm)	8 pcs.
C		JCBC Bolts (M6x40mm)	4 pcs.
D		Wood Screws (M4x32mm)	28 pcs.
E		70mm Allen Key	1 pc.
F		JCBC Bolts (M6x50mm)	6 pcs.
G		JCBC Bolts (M6x60mm)	0 pcs. for Twin/Twin XL 4 pcs. for Full/Queen 8 pcs. for King/Cal King
H		M6 Washers	12 pcs.
I		M6 Spring Washers	10 pcs.
J		Leg Adjusters	0 pcs. for Twin/Twin XL 4 pcs. for Full/Queen 8 pcs. for King/Cal King
K		JCBB Bolts (M8x20mm)	8 pcs.

TOOLS NEEDED: Phillips Screwdriver



4

Note that King and Cal King sizes include two center support rails per slat set. Twin and Twin XL sizes do not include center support rails.

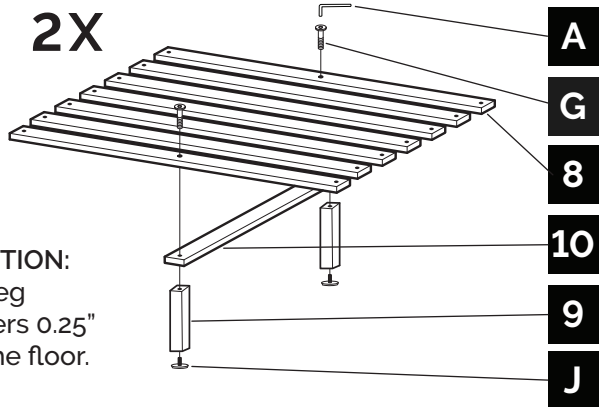

5

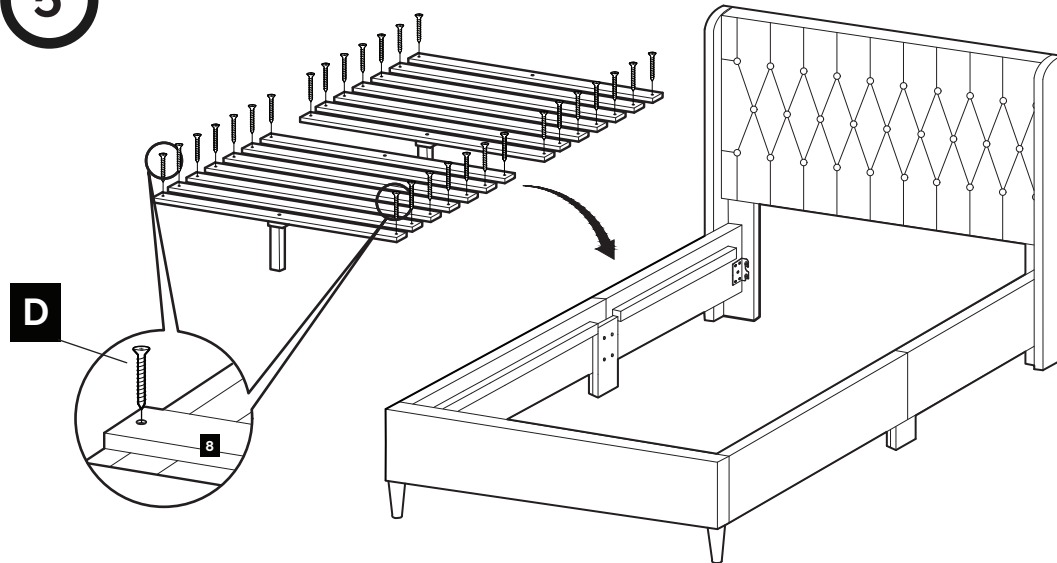

6

Lift the bed with two or more people. Dragging the bed may cause damage.

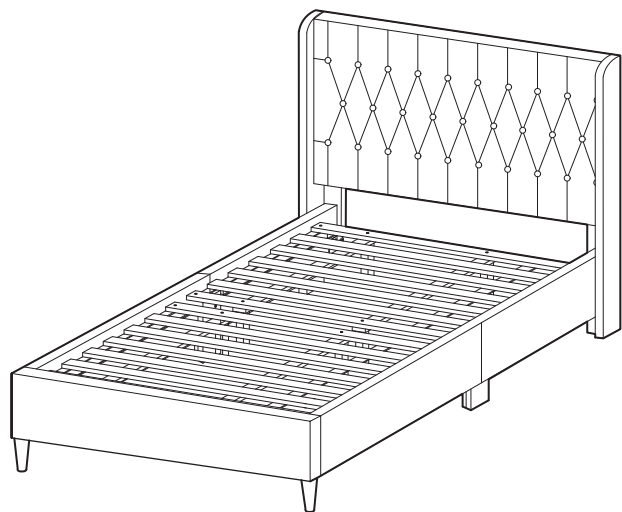

2-YEAR LIMITED WARRANTY

WHAT IS COVERED

This warranty covers any defects in materials or workmanship, with the exceptions stated below.

HOW LONG COVERAGE LASTS

This warranty runs for two (2) years as long as the original purchaser owns the product.

WHAT IS NOT COVERED

The warranty applies only to the original purchaser and does not cover: (a) wear and tear; (b) improper maintenance, misuse, or alteration; (c) repair by unauthorized representatives; (d) damage resulting from transit or handling; or (e) transportation costs.

WHAT WE WILL DO

At our sole discretion we will repair, replace, or refund any product that proves to be defective in materials or workmanship.

HOW TO GET SERVICE

E-mail "warranty@mavenliving.com" to submit your warranty claim. Please keep your receipt so that we may process your warranty request.

HOW STATE LAW APPLIES

This warranty gives you specific legal rights, and you may also have other rights which vary from state to state.

The foregoing warranty shall be exclusive and in lieu of any other warranty, express or implied, including warranties of merchantability and fitness for a particular purpose and all other warranties otherwise arising by operation of law, course of dealing, custom, trade, or otherwise. Neither the seller nor the manufacturer shall be liable for any injury, loss or damage, direct or consequential arising out of the use or inability to use this product.