



MANHATTAN
COMFORT

ASSEMBLY INSTRUCTIONS

INSTRUCCIONES DE MONTAJE

NOTICE DE MONTAGE

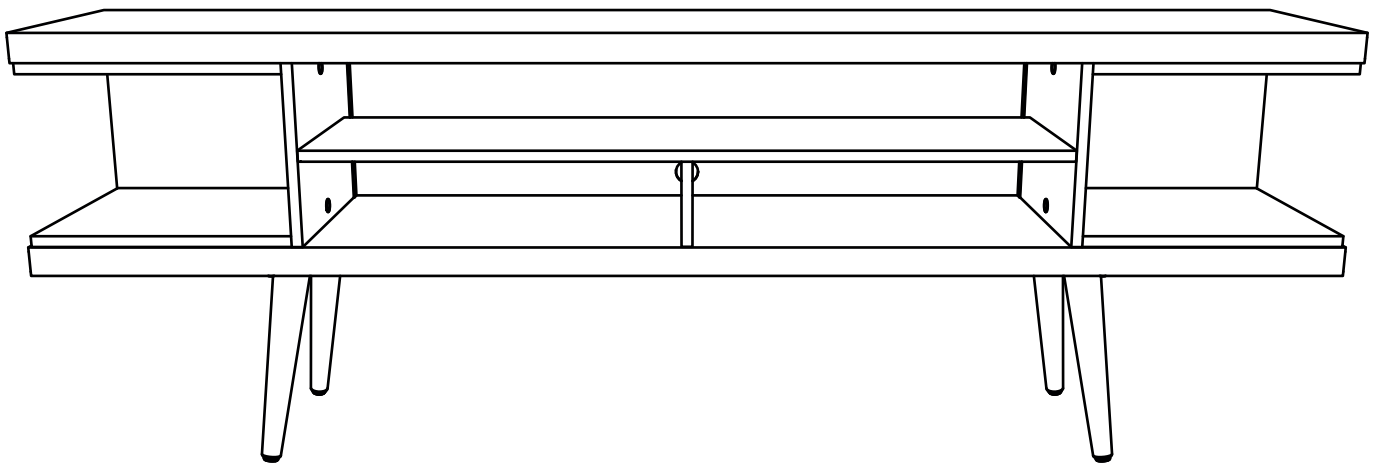

COD:19700

REV. 05 - 20/05/21

STICKER-4x
ADHESIVO-4x
AUTOCOLLANT-4x

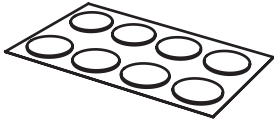

A

COD. 10063 - 12x



B

COD. 1668 - 24x
6.0 X 30



C

COD. 8471 - 4x

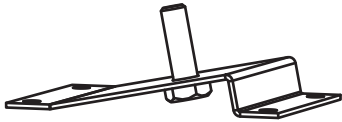

D

COD. 0599 - 12x



E

COD. 3706 - 8x
4.0 X 30

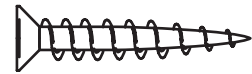

F

COD. 8056 - 16X
4.5 X 16

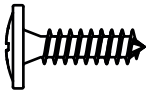

G

COD. 9333 - 8X
5.0 X 50



H

COD. 0357 - 23X
8.0 X 8.0

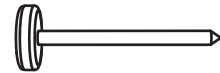

I

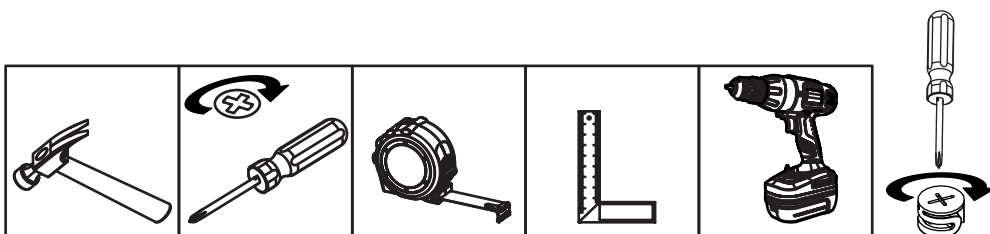

DESCRIPTION

DESCRIPCIÓN

DESCRIPTION

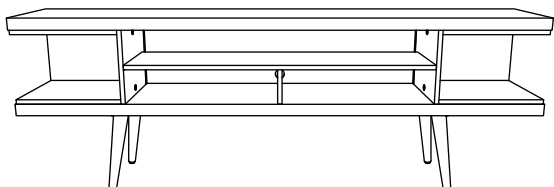

W70.67 inches H:24.02 inches D: 14.02 inches
 L:1795mm A:610mm P:356 mm
 L:1795mm H:610mm P:356 mm

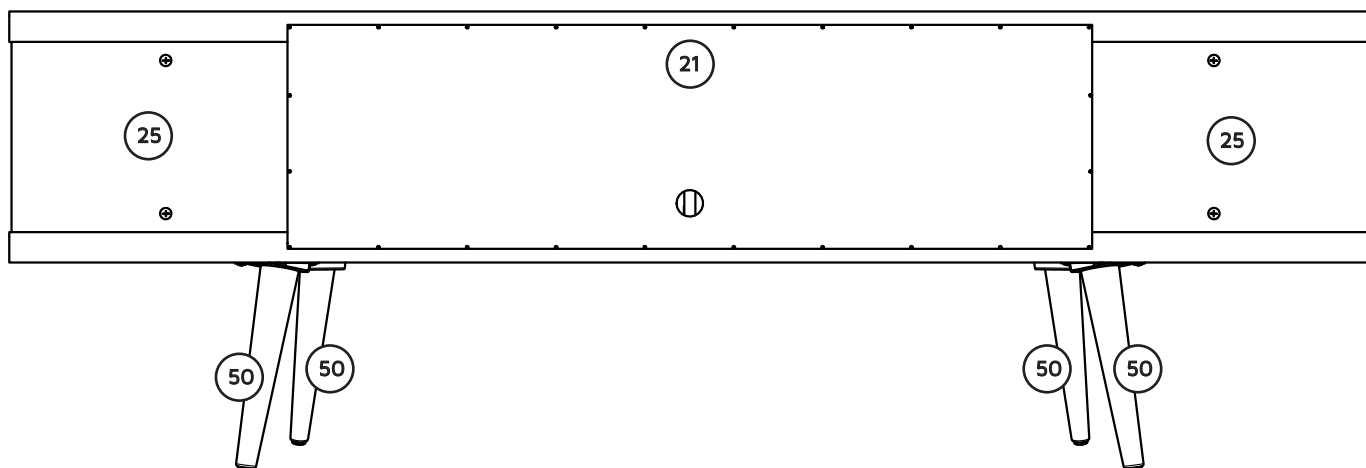
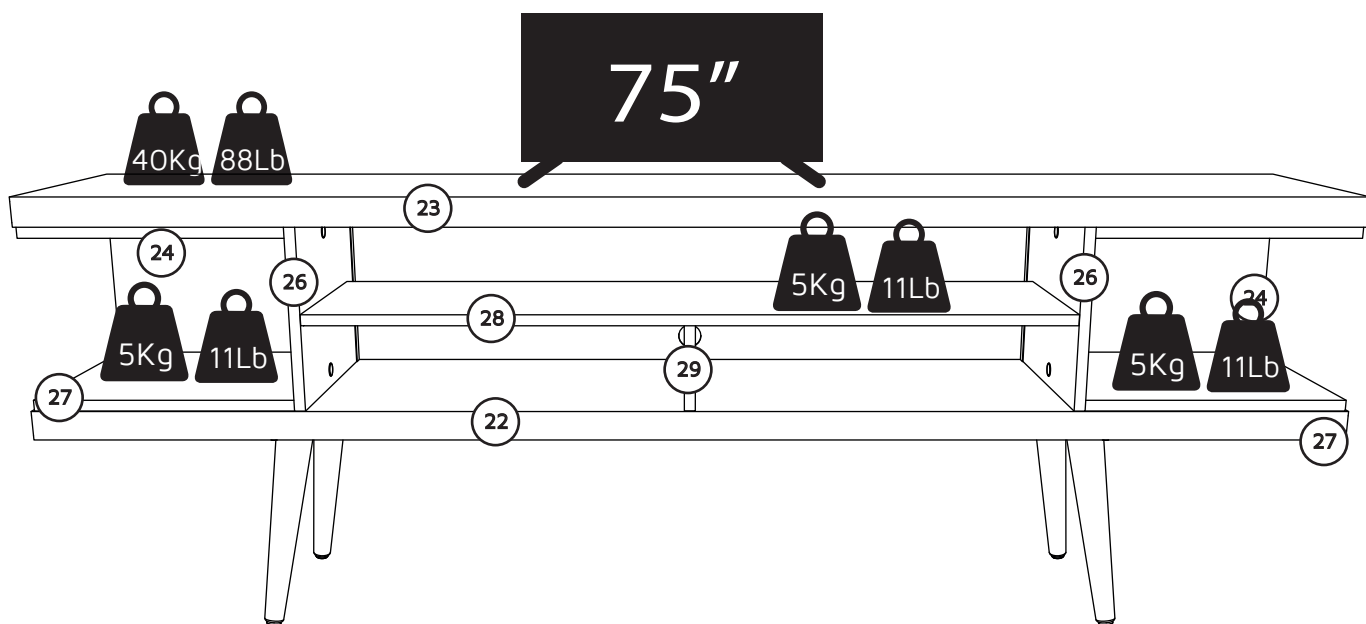

CÓD:19700					
PART PIEZA	QUANTITY CANTIDAD	DESCRIPTION	DESCRIPCIÓN	DESCRIPTION	BOX CAJA BOÎTE
21	01	BACK PLATE	FONDO	FOND	01
22	01	BASE	BASE	BASE	01
23	01	TOP BOARD	CUBIERTA	PLATEAU	01
24	02	NICHE TOP PANEL	SUPERIOR NICH	LATTES INFÉRIEURES	01
25	02	NICHE BACK PANEL	FONDO NICH	FOND DE L'ÉTAGÈRE CARRÉ	01
26	02	SIDE NICHE	NICH	ÉTAGÈRE CARRÉ CÔTÉ	01
27	02	NICHE BOTTOM	NICH	BAS DE L'ÉTAGÈRE CARRÉ	01
28	01	LONG DIVIDER	DIVISION MAYOR	DIVISEUR PLUS GRAND	01
50	04	LEG	PATA	PIED	01

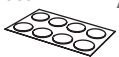

01

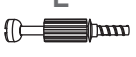

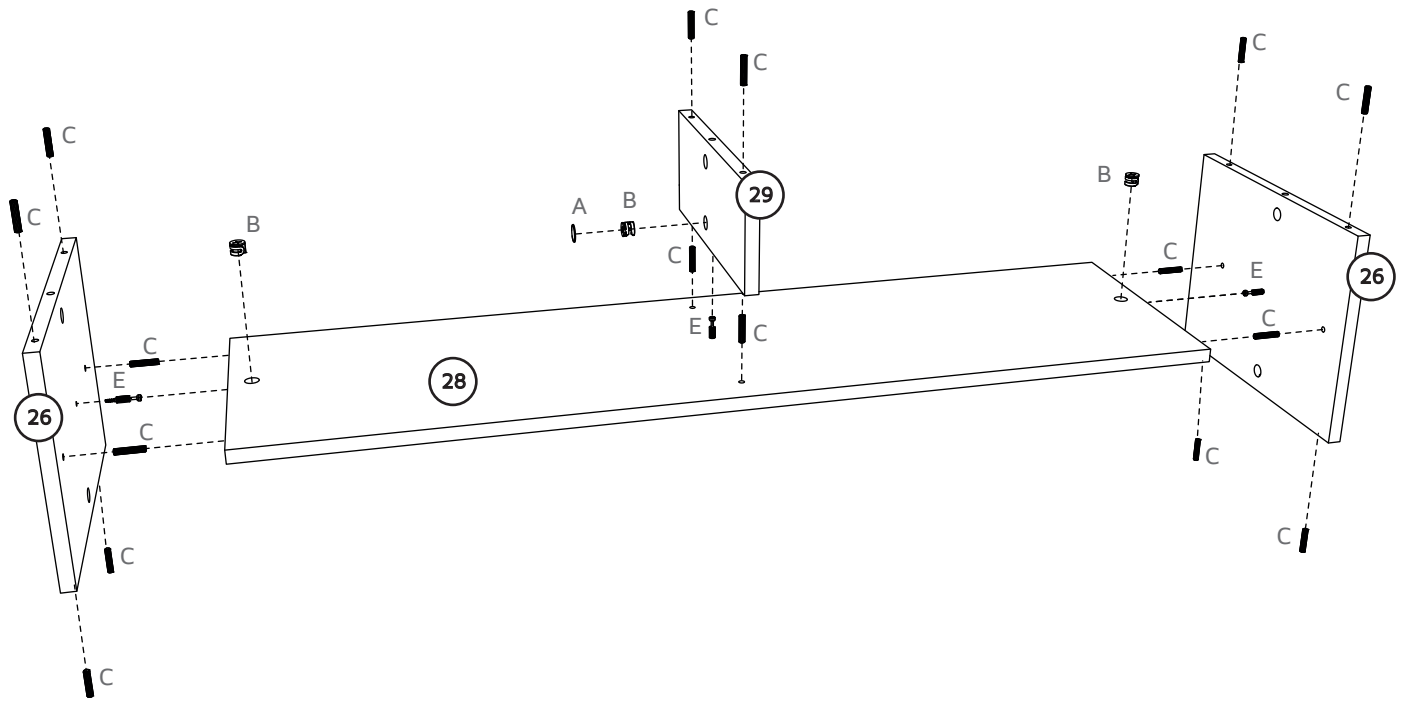

STICKER ADHESIVO AUTOCOLLANT A 	COD. 10063 B 	COD. 1668 C 	COD. 0599 E 
--	--	---	---

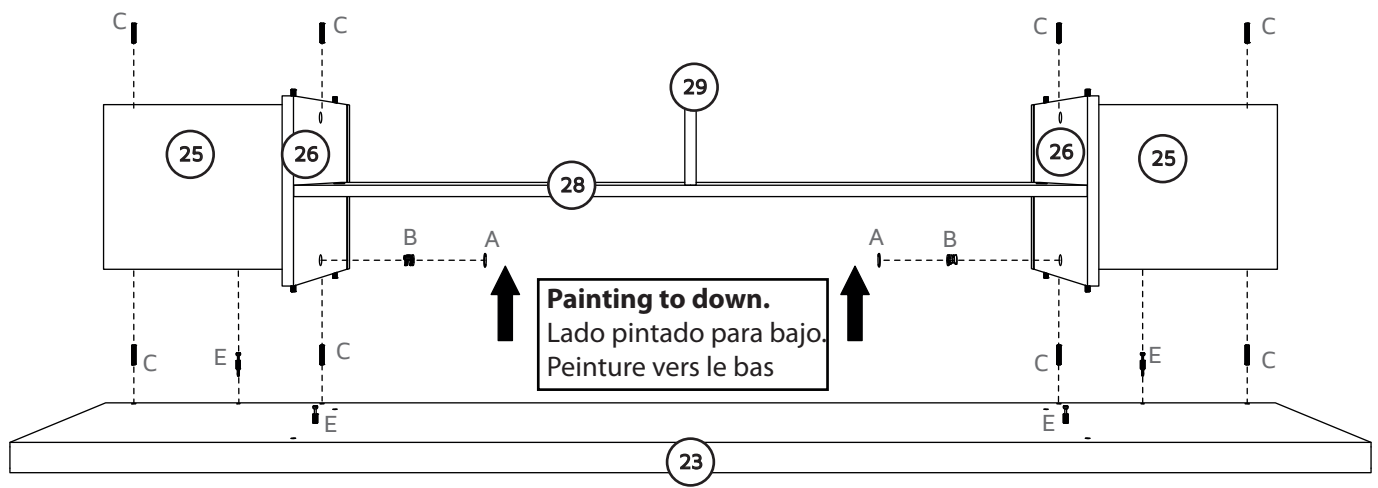

02

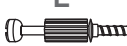

03

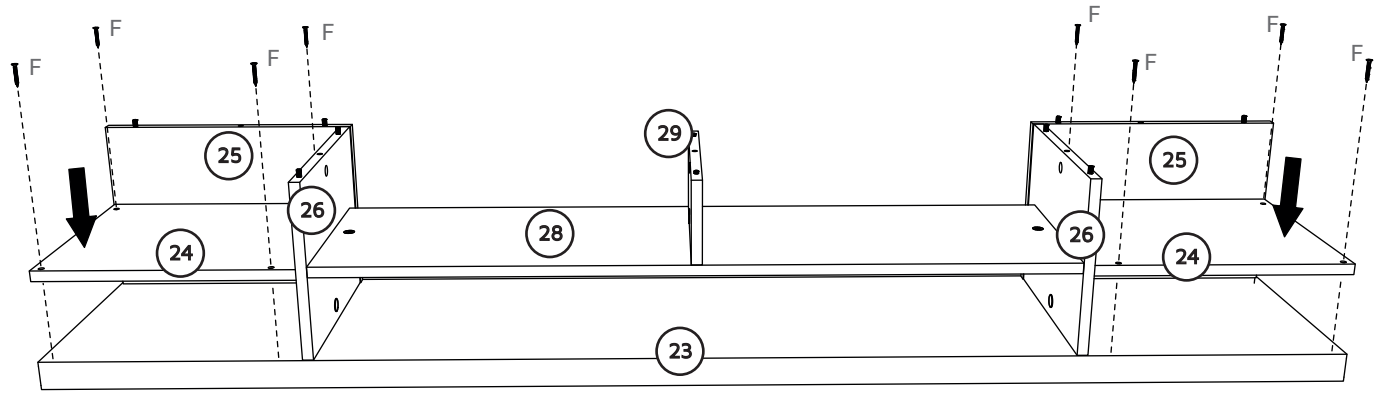

STICKER ADHESIVO AUTOCOLLANT A 	COD. 10063 B 	COD. 0599 E 	COD. 3706 F 
---	---	--	--

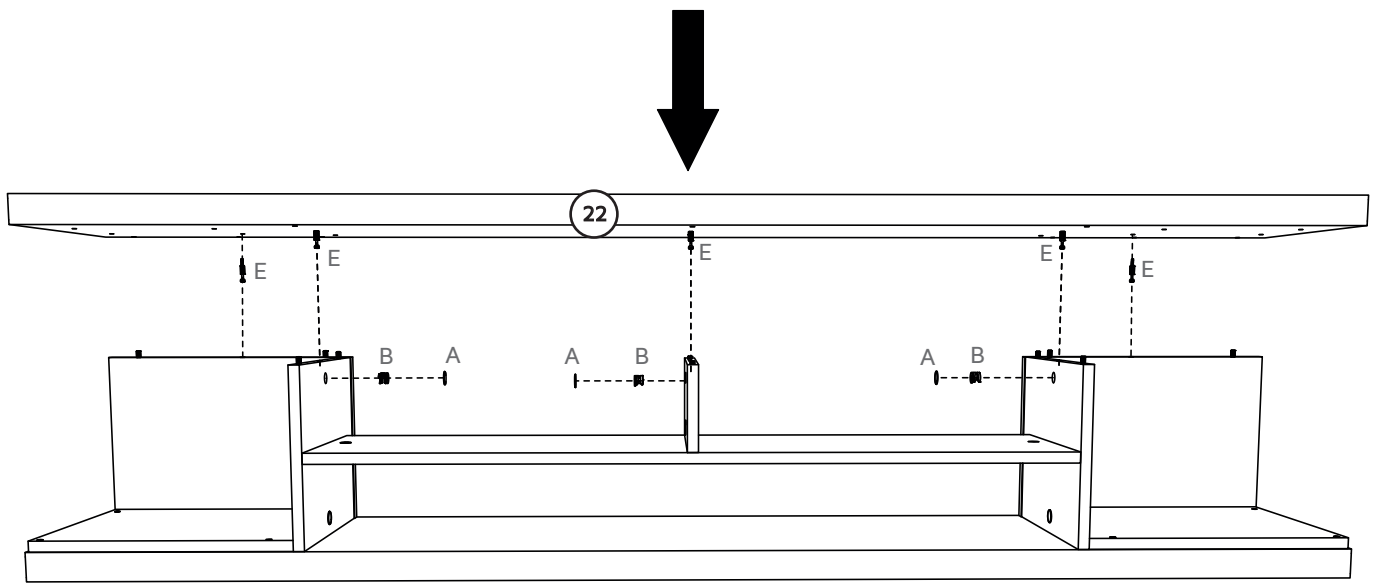

04

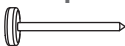

05

COD. 10063 B 	COD. 9333 H 	COD. 0357 I 
---	--	--

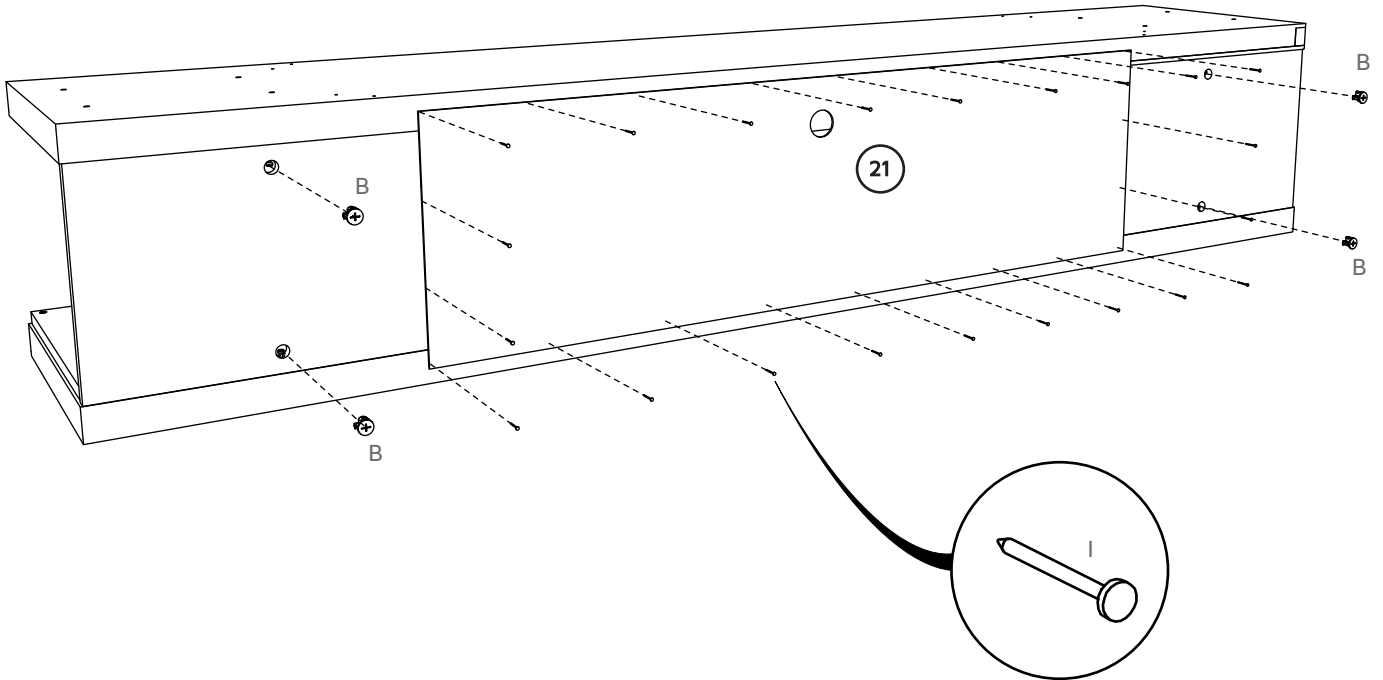

06

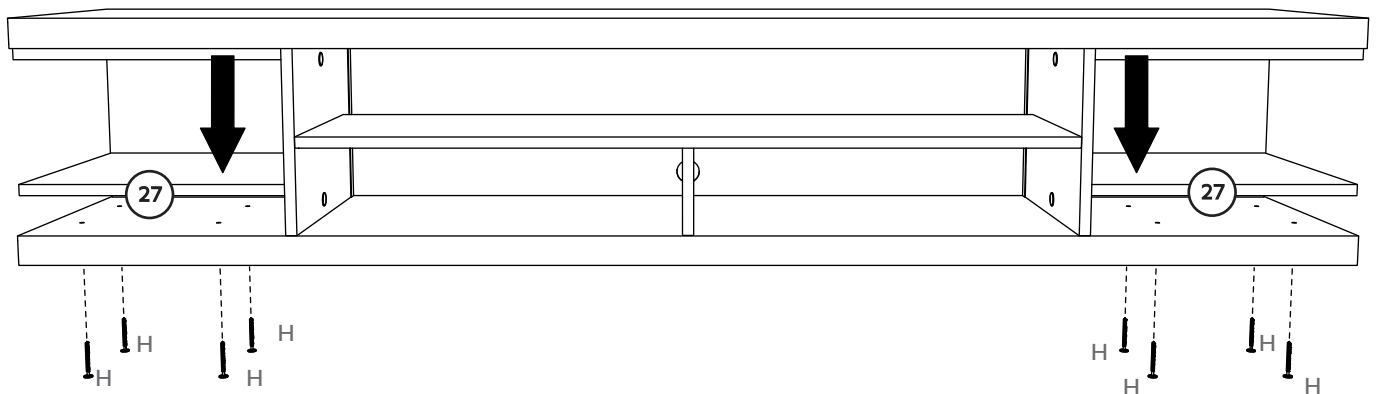

07

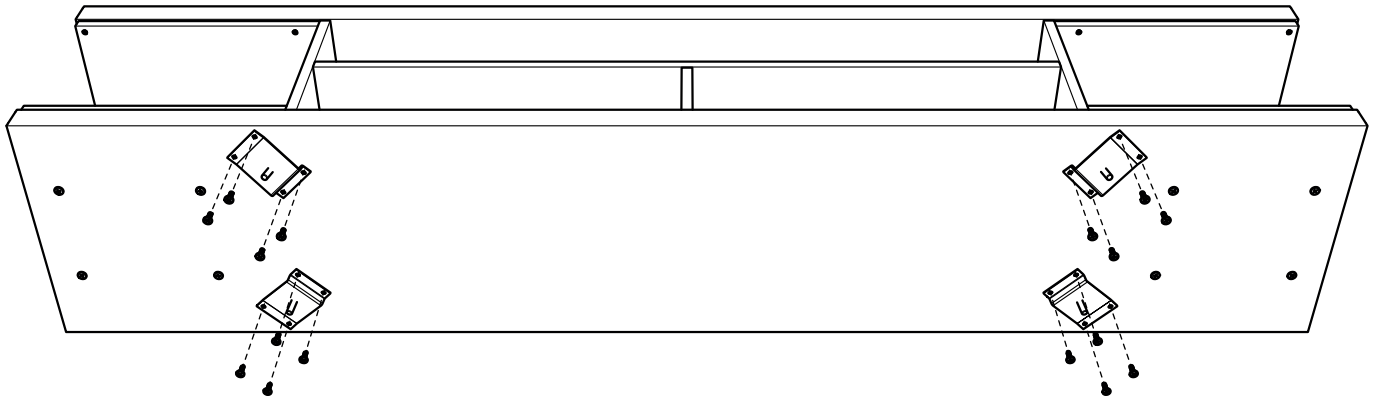
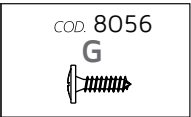
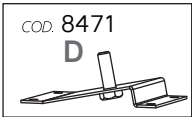

Place them using pilot hole.
 Posicionar usando agujero piloto.
 Positionnez à l'aide du trou de guidage.

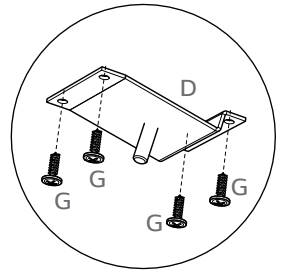
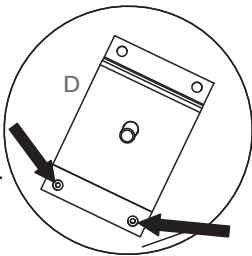

08

