

# MK-101 TILE SAW

## OWNER'S MANUAL, PARTS LIST & OPERATING INSTRUCTIONS



Part # 151991

Revision 106	11.2013
Manual Part# 153754	

**Caution:** Read all safety and operating instructions before using this equipment. This owner's manual **MUST** accompany the equipment at all times.

## INTRODUCTION

Congratulations on your purchase of a MK-101 Tile Saw. We are certain that you will be pleased with your purchase. MK Diamond takes pride in producing the finest construction power tools and diamond blades in the industry.

Operated correctly, your MK-101 Tile Saw should provide you with years of service. In order to help you, we have included this manual. This owners manual contains information necessary to operate and maintain your MK-101 Tile Saw safely and correctly. Please take the time to familiarize yourself with the MK-101 Tile Saw by reading and reviewing this manual.

Read and follow all safety, operating and maintenance instructions.

If you should have questions concerning your MK-101 Tile Saw, please feel free to call our friendly customer service department at: 800 421-5830

Regards,

MK Diamond

### NOTE THIS INFORMATION FOR FUTURE USE:

<b>MODEL NUMBER:</b>	
<b>SERIAL NUMBER:</b>	
<b>PURCHASE PLACE:</b>	
<b>PURCHASE DATE:</b>	

**NOTE:** For your (1) one year warranty to be effective, complete the warranty card (including the Serial Number) and mail it in as soon as possible.

# TABLE OF CONTENTS

	<b>Page</b>
<b>SAFETY</b>	
Safety Messages	4
Damage Prevention Message	4
General Safety Precautions	4-7
California Proposition 65 Message	8
Electrical Requirements and Grounding Instructions	9-10
Electric Motor Safety	11-12
Safety Label Locations	10
Product Specifications	13
<b>ASSEMBLY</b>	
Unpacking	14
Contents	14
Transport	15
Stand	15
Assembly	16-18
<b>SETUP, ADJUSTMENT AND OPERATION</b>	
Setup	19-121
Operation	22-25
Adjustment	26-27
Cleanup	28
<b>MAINTENANCE AND TROUBLESHOOTING</b>	
Maintenance	29-34
Troubleshooting	35-37
<b>EXPLODED VIEW AND PARTS LIST</b>	
Exploded View	38-39
Parts List	40-43
<b>ACCESSORIES</b>	
Accessories	44
<b>ORDERING and RETURN INSTRUCTIONS</b>	
Ordering Information	46
Return Material Policy	46
Packaging Instructions	47
Authorized Service Centers	47
Warranty	47

Read and follow all safety, operating and maintenance instructions. Failure to read and follow these instructions could result in injury or death to you or others. Failure to read and follow these instructions could also result in damage and/or reduced equipment life. Safety warnings and guidelines do not by themselves eliminate danger. They are not substitutes for proper accident prevention procedures and good judgement.

## SAFETY MESSAGES

A safety message alerts you to potential hazards that could hurt you or others. Each safety message is preceded by a safety alert symbol (  ) and one of three words: **DANGER**, **WARNING**, or **CAUTION**.



**DANGER** You **WILL** be **KILLED** or **SERIOUSLY INJURED** if you **DO NOT** follow directions.



**WARNING** You **CAN** be **KILLED** or **SERIOUSLY INJURED** if you **DO NOT** follow directions.



**CAUTION** You **CAN** be **INJURED** if you **DO NOT** follow directions. It may also be used to alert against unsafe practices.

## DAMAGE PREVENTION AND INFORMATION MESSAGES

A Damage Prevention Message is to inform the user of important information and/or instructions that could lead to equipment or other property damage if not followed. Information Messages convey information that pertains to the equipment being used. Each message will be preceded by the word **NOTE**, as in the example below.

**NOTE:** Equipment and/or property damage may result if these instructions are not followed.

## GENERAL SAFETY PRECAUTIONS AND HAZARD SYMBOLS

In order to prevent injury, the following safety precautions and symbols should be followed at all times!



**ALWAYS** read this Owner's Manual before operating the machine. **DO NOT** operate or service this equipment before reading this entire manual. Read and understand all warnings, instructions and controls on the machine. Know how to stop the equipment quickly in case of emergency. It is the operators responsibility to use this machine under safe working conditions and conform with federal, state and local codes or regulations pertaining to safety, air, pollution, noise etc...



**ALWAYS** keep the Blade and Belt Guards in place. **DO NOT** operate this machine with any guard or safety device removed. A Guard, or any damaged part should be repaired or replaced immediately.



### REMOVE ADJUSTING KEYS AND WRENCHES

Form a habit of checking to see that keys and adjusting wrenches are removed from the power tool before it is turned on.



### KEEP WORK AREA CLEAN

Cluttered work areas and benches invite accidents.



### DO NOT USE IN DANGEROUS PLACES

**DO NOT** use power tools in damp or wet locations nor expose them to rain. Always keep the work area well lighted.

**KEEP CHILDREN AWAY**

All visitors and children should be kept a safe distance from work area.

**MAKE THE WORKSHOP KID PROOF**

Make the workshops kid proof by using padlocks, master switches or by removing starter keys.

**DO NOT FORCE THE TOOL**

A power tool will do a job better and safer operating at the rate for which it was designed.

**USE THE RIGHT TOOL**

**DO NOT** force a tool or an attachment, to do a job that it was not designed to do.

**USE THE PROPER EXTENSION CORD**

If using an extension cord make sure it is in good condition first. When using an extension cord, be sure to use one heavy enough to carry the current your product will draw. An undersized cord will cause a drop in line voltage that will result in a loss of power and overheating. Page 9 shows the correct AWG size to use depending on cord length and nameplate ampere rating. If in doubt, use the next heavier gauge. The smaller the gauge number, the heavier the cord.

**USE PROPER APPAREL**

**DO NOT** wear loose clothing, gloves, neckties, rings, bracelets, or other jewelry that may be caught in moving parts. Non-slip footwear is recommended. Wear protective hair covering to contain long hair.

**PERSONAL PROTECTIVE EQUIPMENT**

**ALWAYS** wear approved respiratory, head, ear and eye protection when operating this machine.

**SECURE WORK**

Clamps or a vise should be used to hold work whenever practical. Keeping your hands free to operate a power tool is safer.

**DO NOT OVERREACH**

Keep proper footing and balance at all times by not overreaching.

**MAINTAIN TOOLS WITH CARE**

Keep tools clean for the best and safest performance. Always follow maintenance instructions for lubricating, and when changing accessories.

**DISCONNECT TOOLS**

Power tools should always be disconnected before servicing or when changing accessories, such as blades, bits, cutters, and the like.



**ALWAYS** place the power ON/OFF switch in the **OFF** position when the saw is not in use.

**USE RECOMMENDED ACCESSORIES**

Consult the owner's manual for recommended accessories. Using improper accessories may increase the risk of personal or by-stander injury. Unauthorized equipment modifications will void all warranties. Manufacturer does not assume responsibility for any accident due to equipment modifications.



**ALWAYS** ensure that the machine is on level ground before using.

**NEVER STAND ON THE TOOL**

Serious injury could occur if a power tool is tipped, or if a cutting tool is unintentionally contacted.

**TRANSPORT**

When loading or unloading the machine, use caution. Remove the blade prior to hoisting, loading and transporting the machine.

**CHECK FOR DAMAGED PARTS**

Before using a power tool, check for damaged part. A guard or any other part that is damaged should be carefully checked to determine if would operate properly and perform its intended function. Always check moving parts for proper alignment or binding. Check for broken parts and mountings and all other conditions that may affect the operation of the power tool. A guard, or any damaged part, should be properly repaired or replaced.

**DIRECTION OF ROTATION**

A blade or cutter should always be installed so that rotation is in the direction of the arrow imprinted on the side of the blade or cutter. It should correspond with the rotational direction of the motor. Always feed work into a blade against the direction of rotation.

**NEVER LEAVE A TOOL UNATTENDED**

**TURN POWER OFF** - Do not leave a tool until it comes to a complete stop. Always turn a power tool OFF when leaving the work area, or, when a cut is finished.



**NEVER** disconnect any "emergency or safety devices". These devices are intended for operator safety. Disconnection of these devices can cause severe injury, bodily harm, or even death! Disconnection of any of these devices will void all warranties. Unauthorized equipment modifications will void all warranties. Manufacturer does not assume responsibility for any accident due to equipment modifications.



**NEVER** operate this equipment when not feeling well due to fatigue, illness or taking medicine.



Check the chemical properties of the material to be cut/grinded and follow all EPA/OSHA Regulations.

 **WARNING**

Diamond Blades improperly used are dangerous. Comply with American National Standards Institute Safety Code, B7.1 and, Occupational Safety and Health Act covering Speed, Safety Guards, Flanges, Mounting Procedures, General Operating Rules, Handling, Storage and General Machine Conditions

**ELECTRICAL SHOCK**

**NEVER** touch electrical wires or components while the engine is running. Exposed, frayed or worn electrical wiring and plugs can be sources of electrical shock which could cause severe injury or burns. Do not touch the plug with wet hands.

**ROTATING PARTS**

Keep hands, feet, hair, and clothing away from all moving parts to prevent injury. Never operate the motor with covers, shrouds, or guards removed.

**OVER SPEED**

**NEVER** tamper with the governor components or settings to increase the maximum speed. Severe personal injury and damage to the engine or equipment can result if operated at speeds above maximum.

**DO NOT EXPOSE TO RAIN**

**DO NOT** expose to rain or use in damp locations.

## **SILICA DUST WARNING**

---

Grinding/cutting/drilling of masonry, concrete, metal and other materials with silica in their composition may give off dust or mists containing crystalline silica. Silica is a basic component of sand, quartz, brick clay, granite and numerous other minerals and rocks. Repeated and/or substantial inhalation of airborne crystalline silica can cause serious or fatal respiratory diseases, including silicosis. In addition, California and some other authorities have listed respirable crystalline silica as a substance known to cause cancer. When cutting such materials, always follow respiratory precautions.

Use appropriate NIOSH-approved respiratory protection where dust hazard may occur. Paper masks or surgical masks without a NIOSH approval number are not recommended because they do little to protect the worker. For more information about respirator programs, including what respirators have received NIOSH approval as safe and effective, please visit the NIOSH website at:

<http://www.cdc.gov/niosh/topics/respirators>

Observe OSHA regulations for respirator use (29 C.F.R. §1910.134 and §1503.1).

Visit <http://www.osha.gov> for more information.

## **CALIFORNIA PROPOSITION 65 MESSAGE**

---

Some dust created by power sanding, sawing, grinding, drilling, and other construction activities contain chemicals known (to the State of California) to cause cancer, birth defects or other reproductive harm. Some examples of these chemicals are:

- Lead, from lead-based paints
- Crystalline silica from bricks, cement and other masonry products
- Arsenic and chromium, from chemically treated lumber

For further information, consult the following sources:

<http://www.osha.gov/dsg/topics/silicacrystalline/index.html>

<http://www.cdc.gov/niosh/docs/96-112/>

<http://oehha.ca.gov/prop65/law/P65law72003.html>

<http://www.dir.ca.gov/Title8/sub4.html>

Your risk from these exposures varies depending on how often you do this type of work. To reduce your exposure to these chemicals, work in a well-ventilated area, and work with approved safety equipment, such as dust masks that are specially designed to filter out microscopic particles. Where use of a dust extraction device is possible, it should be used. To achieve a high level of dust collection, use an industrial HEPA vacuum cleaner. Observe OSHA 29 CFR part 1926.57 and 1926.103.



### **WARNING**

Sawing and drilling generate dust. Excessive airborne particles may cause irritation to eyes, skin and respiratory tract. To avoid breathing impairment, always employ dust controls and protection suitable to the material being sawed or drilled; See OSHA (29 CFR Part 1910.1200).



## ELECTRICAL REQUIREMENTS AND GROUNDING INSTRUCTIONS

In order to prevent potential electrical shock and injury, the following electrical safety precautions and symbols should be followed at all times!

### WARNING

In case of a malfunction or breakdown, grounding provides a path of least resistance for electric current to reduce the risk of electric shock. This tool is equipped with an electric cord having an equipment-grounding conductor and a grounding plug. The plug must be plugged into a matching outlet that is properly installed and grounded in accordance with all local codes and ordinances.

- Do not modify the plug provided – if it will not fit the outlet; have the proper outlet installed by a qualified electrician
- Improper connections of the equipment-grounding conductor can result in a risk of electric shock. The equipment-grounding conductor is the insulated conductor that has an outer surface that is green, with or without yellow stripes. If repair or replacement of the electric cord or plug is necessary, do not connect the equipment-grounding conductor to a live terminal
- Check with a qualified electrician or service personnel if the grounding instructions are not completely understood, or if in doubt as to whether the tool is properly grounded
- Use only 3-wire extension cords that have 3-prong grounding plugs and 3-pole receptacles that accept the tool's plug
- Repair or replace a damaged or worn cord immediately

### WARNING

This tool is intended for use on a circuit that has an outlet that looks like the one shown in Sketch A. The tool has a grounding plug that looks like the plug illustrated in Sketch A. A temporary adapter, which looks like the adapter illustrated in sketches B and C, may be used to connect this plug to a 2-pole receptacle as shown in Sketch B, if a properly grounded outlet is not available. The temporary adapter should be used only until a properly grounded outlet can be installed by a qualified electrician. The green-colored rigid ear, lug, and the like, extending from the adapter, must be connected to a permanent ground such as a properly grounded outlet box.

**NOTE:** Use of a temporary adapter is not permitted in Canada.

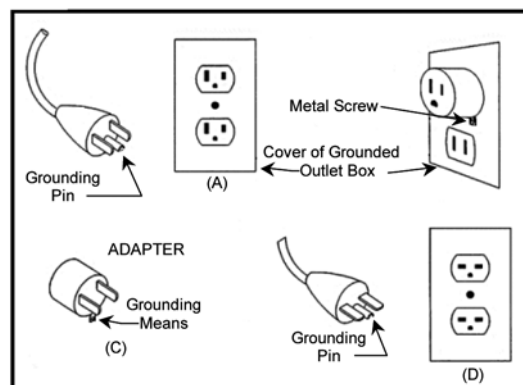

## ELECTRIC MOTOR SAFETY

For maintenance care and operation of the electric motor, refer to your electric motor instruction booklet furnished with the electric motor. Protect the electric motor from dust as much as possible and keep ventilating openings clean. Before plugging in the machine, make sure that the outlet voltage is within the voltage marked on the machines's data plate.



### CAUTION



**DO NOT** spray water on the electric motor. **DO NOT** touch the plug with wet hands. To reduce the risk of electrocution, keep all connections dry and off the ground.



**DO NOT** operate electric motor in an explosive environment.



### DO NOT EXPOSE TO RAIN

**DO NOT** expose to rain or use in damp locations.



### WARNING



If operating the equipment in damp locations is unavoidable, **ALWAYS** use a Ground Fault Circuit Interrupter, **ALWAYS** wear rubber gloves and footwear in damp conditions.



**DO NOT** abuse the cord. Never use the cord to carry the equipment or to pull the plug from the outlet. Keep the cord away from heat, sharp edges, and moving parts. Replace damaged cords immediately. Damaged cords increase the risk of electric shock.



### WARNING

To reduce the risk of electrocution, keep all connections dry and off the ground. A Ground Fault Circuit Interrupter (GFCI) should be provided on the circuit(s) or outlet(s) to be used for this machine. Receptacles are available having built-in GFCI protections and may be used for this measure of safety. When using an extension cord, GFCI should be installed closest to the power source, followed by the extension cord and lastly, the machine.



### WARNING

The water pump requires a GFCI. To reduce risk of electrical shock when operating the machine with the pump plugged into the 3-pole receptacle on the motor, connect the saw to a GFCI outlet. See the pump manual and informational tags enclosed separately for all pump information.



### WARNING

To avoid the possibility of the appliance plug or receptacle getting wet, position the machine to one side of a wall mounted receptacle. This will prevent water from dripping onto the receptacle or plug. A “drip loop,” shown in the picture below, should be arranged by the user to properly position the power cord relative to the power source.

 **WARNING**

The “drip loop” is that part of the cord below the level of the receptacle, or the connector, if an extension cord is used. This method of positioning the cord prevents the travel of water along the power cord and coming in contact with the receptacle.

If the plug or receptacle gets wet, **DO NOT** unplug the cord. Disconnect the fuse or circuit breaker that supplies power to the tool. Then unplug and examine for presence of water in the receptacle.

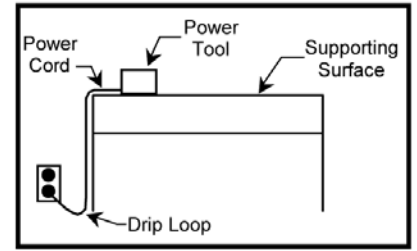

**Drip Loop Information**

 **WARNING**



Use only extension cords that are intended for outdoor use. These extension cords are identified by a marking “Acceptable for use with outdoor appliances; store indoors while not in use.” Use only extension cords having an electrical rating not less than the rating of the product. Do not use damaged extension cords. Examine extension cords before using and replace if damaged. Do not abuse extension cords and do not yank on any cord to disconnect. Keep cords away from heat and sharp edges. Always disconnect the extension cord from the receptacle before disconnecting the product from the extension cord.

 **WARNING**



To reduce the risk of electrocution, keep all connections dry and off the ground. **DO NOT** touch the plug with wet hands.

 **WARNING**

Use of under sized extension cords result in low voltage to the motor that can result in motor burnout and premature failure. MK Diamond warns that equipment returned to us showing signs of being run in a low voltage condition, through the use of undersized extension cords will be repaired or replaced totally at the customer's expense. There will be no warranty claim.

To choose the proper extension cord,

- Locate the length of extension cord needed in the table below.
- Once the proper length is found, move down the column to obtain the correct AWG size required for that length of extension cord.

EXTENSION CORD LENGTH							
Nameplate Amperes	115V	25'	50'	75'	100'	150'	200'
	250V	50'	100'	150'	200'	300'	400'
0 - 5		16	16	16	14	12	12
5.1 - 8		16	16	14	12	10	•
8.1 - 12		14	14	12	10	•	•
12.1 - 15		12	12	10	10	•	•
15.1 - 20		10	10	10	•	•	•

**SAFETY LABEL LOCATIONS**

Safety labels contain important safety information. Please read the information contained on each safety label. These labels are considered a permanent part of your saw. If a label comes off or becomes hard to read, contact MK Diamond or your dealer for a replacement.

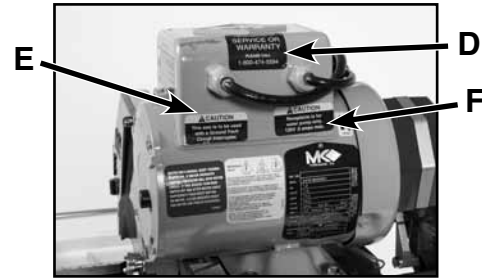
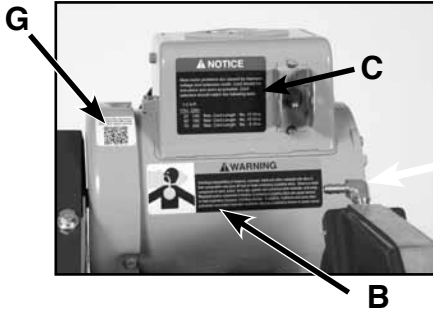

Label A

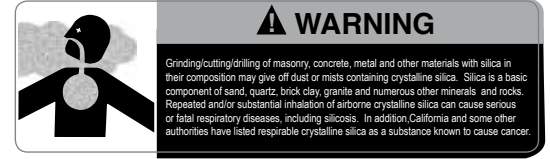

Label B

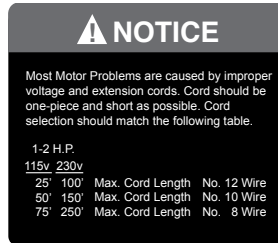

Label C



Label D



Label E

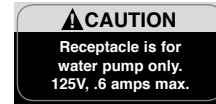

Label F



Label G

Warning Label Sheet Part # 166012



Label H

Decal/Label	Location	Description
A	Motor - Side	Warning - Read and Follow Operating Instructions
B	Motor - Front	Warning - Silica Warning
C	Motor - Front	Notice - Voltage/Extension Cords
D	Motor - Back	Service/ Warranty
E	Motor - Back	Caution - Use with GFCI only
F	Motor - Back	Caution - Receptacle for water pump
G	Motor - Back	QR Code for Manuals
H	Water Pump	Pump Specifications

**PRODUCT SPECIFICATIONS**

The MK-101 is a versatile Tile Saw. Operated and used according to this manual, the MK-101 will provide years of dependable service.

**General Specifications**

The MK-101 Tile Saw is engineered as a tabletop or stand mounted wet tile saw. The saw includes a powerful 120V totally enclosed capacitor start Baldor motor with a thermal protective overload. The saw is capable of cutting tile up to twenty (20) inches in length, or diagonal cutting tile up to fourteen (14) inches. The saw can cut an object three (3) inches thick in one pass.

**Motor Specifications**

Motor specifications for the MK-101 are listed in table below.

<b>Voltage</b>	120V
<b>Overall Amperage</b>	13
<b>Motor Only Amperage</b>	14.5
<b>Frequency</b>	60 Hz
<b>RPM</b>	3400 rpm
<b>Horse Power</b>	1.5 hp
<b>Weight</b>	92 lbs

**Thermal Overload Protection**

The motor is protected by a thermal overload equipped with a manual reset.

**Blade Capacity**

The MK-101 uses a ten (10) inch (254mm) diameter, wet cutting continuous rim, diamond blade with a five-eighths (5/8) inch (15.875 mm) arbor.

**Tile Types**

The MK-101 can cut a variety of tile types including Porcelain, Terracotta, Marble, Quarry and Slate, or almost any other non-ferrous material.

**NOTE:** The MK-101 is not designed to cut plastic or ferrous (metals) material.

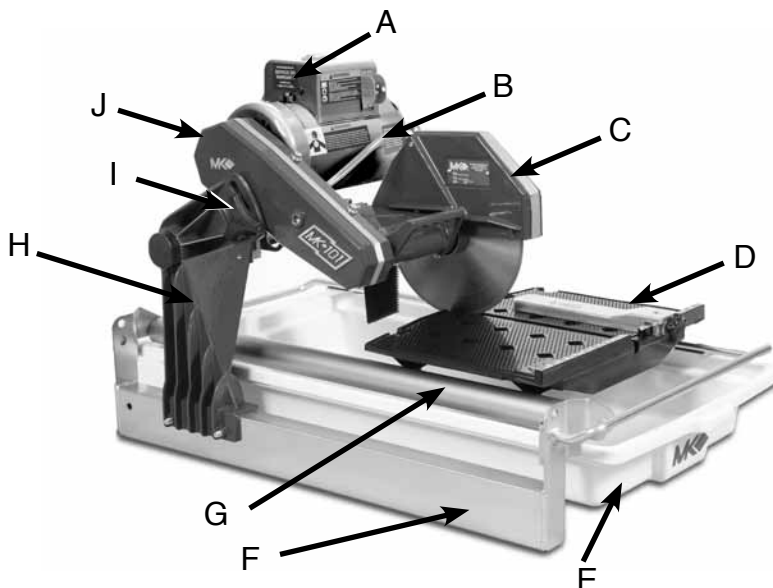

A	Motor
B	Water Pump Tube
C	Blade Guard
D	Cutting Table
E	Water Basin
F	Frame
G	Guide Bar
H	Post
I	Depth of Cut Adjustment Knob
J	Belt Guard

## UNPACKING

Your MK-101 has been shipped from the factory thoroughly inspected. Only minimal assembly is required.

**CAUTION** Use proper lifting techniques when lifting the MK-101.

## CONTENTS

In your container, you will find one (1) MK-101 frame and water basin, one (1) MK-101 Cutting Head, one (1) 10-inch wet cutting continuous rim diamond blade, one (1) adjustable cutting guide, one (1) electric water pump, one (1) 45° miter, one (1) blade wrench, one (1) splash guard, one (1) cooling transfer tube, one (1) flow adjusting clamp, one (1) drain plug, one (1) owners manual, one (1) pump manual and one (1) warranty card.

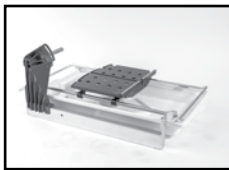

MK-101 Frame  
and Water Basin



MK-101  
Cutting Head



Diamond Blade



Adjustable  
Cutting Guide



Electric Water  
Pump



45° Miter



Blade Wrench

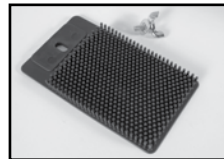

Splash Guard



Cooling Transfer  
Tube



Flow Adjusting  
Clamp



Drain Plug



Owners Manual



Pump Manual

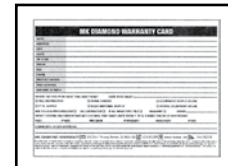

Warranty Card

**TRANSPORT**

- CAUTION** 1. The MK-101 weighs approximately ninety-two (92) pounds.  
2. Never transport the MK-101 with water in the Water Basin.

The MK-101 is designed with a rigid frame and removable Cutting Head. Two people are required to transport the MK-101 with the Cutting Head installed. Remove the Cutting Head if one person is transporting the saw (see Cutting Head Installation and Removal in the following section).

Lift the saw using the lift points shown.

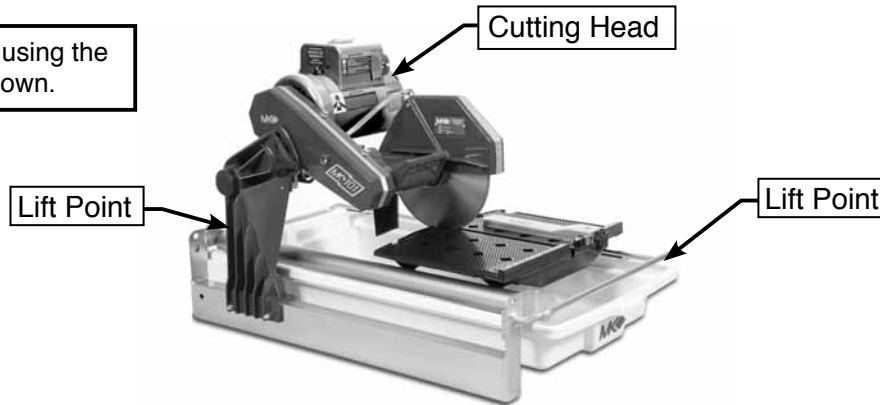
**STAND**

The MK-101 weighs approximately ninety-two (92) pounds; follow the guidelines for transport in the TRANSPORT section, when placing it on the stand.

**NOTE:** If using the MK Diamond stand, follow the following steps.



(A)  
Open the Stand and place on flat surface



(B)  
Remove Water Basin and place saw on stand



(C)  
Ensure saw frame is positioned correctly



(D)  
Reinstall the Water Basin



Follow the assembly instructions to prepare your MK-101 for operation.

**NOTE:** If the cutting head is installed, go to the next step.

## CUTTING HEAD INSTALLATION

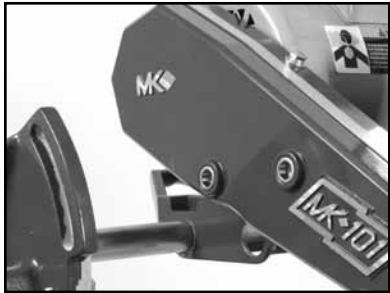

(A)  
Align Cutting Head rear Pivot Hole to the Post Pivot Shaft and slide onto shaft

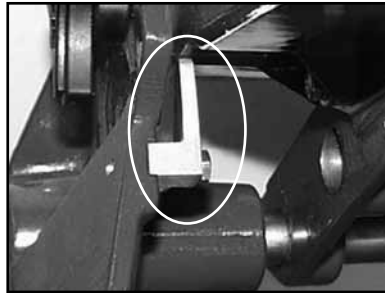

(B)  
Ensure Cutting Head Stop is in upward position



(C)  
Install the Cutting Head onto the Post Pivot Shaft and install the Adjusting Knob

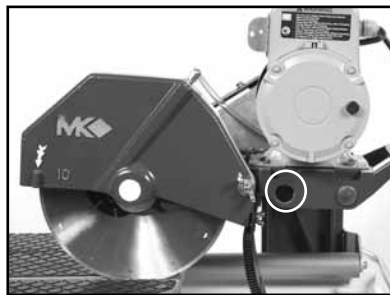

(D)  
For maximum cutting length, the Cutting Head should be in the front pivot hole and the Post should be in the rear post retaining hole.

**NOTE:** For small tiles (6" tile or smaller) the Cutting Head should be in the rear pivot hole and the Post should be in the forward post retaining hole. For large tiles and maximum cutting length, the Cutting Head should be in the front pivot hole and the Post should be in the rear post retaining hole.

**NOTE:** Move Cutting Head Stop in upward position when using rear pivot hole and in the down position when using front pivot hole, refer to page 24.



**DIAMOND BLADE INSTALLATION**

**NOTE:** When installing the Retaining Nut, do not “cross-thread” and DO NOT over tighten.

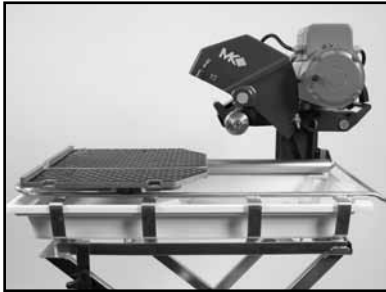

(A)  
Position Movable Cutting Table to the front of the saw and raise the Blade Guard.  
Tighten wing-nut

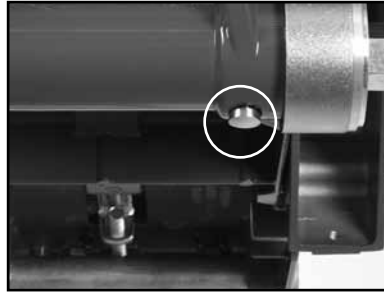

(B)  
Locate the Shaft Lock push button on the underside of the Cutting Head



(C)  
Depress and hold the Shaft Lock pushbutton and remove Retaining Nut and Outer Flange using the Blade Wrench

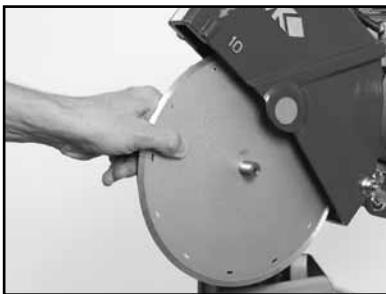

(D)  
Raise Cutting Head and Install Diamond Blade onto Blade Shaft



(E)  
Verify the Blade is seated on the Blade Shaft and direction of rotation is correct

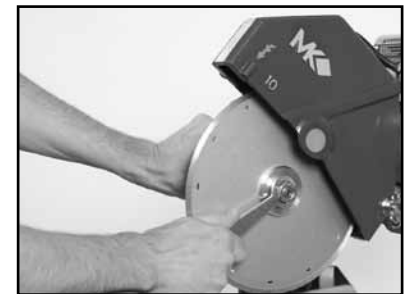

(F)  
Install Retaining Nut and Outer Flange, depress and hold the Shaft Lock pushbutton and tighten

**ADJUSTABLE CUTTING GUIDE INSTALLATION**

**NOTE:** The Adjustable Cutting Guide can be used on either side of the Diamond Blade.



(A)  
Loosen Adjustable Cutting Guide retaining thumbscrew and place it over the Movable Cutting Table Ruler/Stop



(B)  
Place the Adjustable Cutting Guide onto the Movable Cutting Table Ruler/Stop and tighten the retaining thumbscrew

**SPLASH GUARD INSTALLATION**

---



(A)

Install the retaining thumbscrew through the washer and Splash Guard then align to the hole found on back of the Blade Guard



(B)

Install the Splash Guard onto the Blade Guard

**WATER PUMP PREPARATION**

---

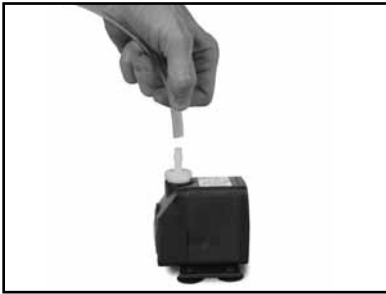

(A)

Press one end of the Cooling Transfer Tube into the Water Pump Discharge Fitting

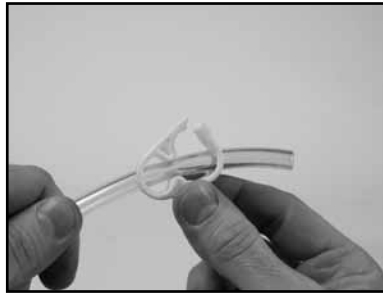

(B)

Slide Cooling Flow Adjusting clamp on to the Cooling Transfer Tube

## PRE-START INSPECTION

Prior to beginning work, a pre-start inspection of the saw should be performed.



(A)

Ensure the ON/OFF Switch is in the OFF position

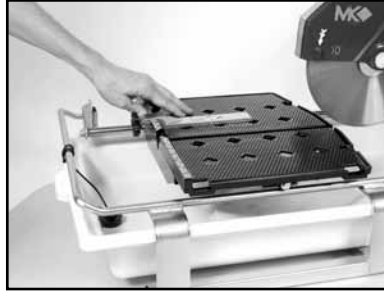

(B)

Verify the Movable Cutting Table moves freely



(C)

Inspect the Diamond Blade for damage – verify the blade is correct for the material being cut



(D)

Inspect the Pump Assembly for damage – ensure the cord is free of cracks or cuts



(E)

Inspect the MK-101 for damage

## CONNECTING THE WATER PUMP

- ⚠ WARNING**
1. To prevent the possibility electrical shock, the MK-101 MUST be de-energized when connecting the Water Pump.
  2. To prevent the possibility of electrical shock, use only MK Diamond qualified replacement parts

**NOTE:** To prevent pump damage, the Water Pump must be disconnected if cutting with a Dry Blade.



(A)

Connect the Cooling Transfer Tube to the inlet connection of the Blade Guard



(B)

Connect the Water Pump power cord to the connection found on the back of the motor

## WATER PUMP SETUP FOR OPERATION

The Water Pump can be setup for operation in two ways, External Water Source or Re-circulation.

**NOTE:** If using a dry blade for operation, DO NOT connect the water pump.

### EXTERNAL WATER SOURCE

This is the preferred method of cooling.



(A)

Remove the Drain Plug. Place empty container under hole for water drainage



(B)

Place the Water Pump in an external container and fill until water completely covers the Water Pump suction

### RE-CIRCULATION

**NOTE:** When using the re-circulation method, the water should be changed often for longer pump life.

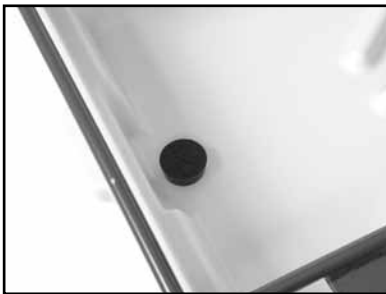

(A)

Ensure the Drain Plug is installed in the Water Basin



(B)

Place the Water Pump in the back of the Water Basin



### **CAUTION**

1. Before powering or starting, check for damage that could prevent this equipment from proper operation or performing its intended function. Check for binding and alignment of moving parts. Check for damaged, broken, or missing parts.
2. Verify the On/Off switch is in the OFF position.
3. Before connecting the MK-101 to a power supply, be sure the voltage, cycle and phase of the job site power source meet the requirements.

<b>VOLTAGE</b>	120V
<b>CYCLE</b>	60hz
<b>PHASE</b>	1-phase

4. If using an extension power cord, made sure, the length and wire gauge correspond to the requirements listed in the table on page 10. An extension power cord that is too small in wire gauge (diameter), or too long in length, will cause the motor to overheat and could cause premature failure.
5. Use an approved Ground Fault Circuit Interrupter (GFCI)
6. Do not cover the motor vents as this could lead to motor overheating.

**NOTE:** In order to avoid breaker tripping, a 20-amp circuit breaker should be used.

**PORTABLE GENERATOR**

If using a portable generator, ensure the generator meets the following minimum requirements:

5 KW                      120/240 volts                      41.7/20.8 amps                      Single Phase

**GROUND FAULT CIRCUIT INTERRUPTER (GFCI)**

This saw is to be used with a Ground Fault Circuit Interrupter.



(A)  
Ensure the ON/OFF Switch is in the OFF position



(B)  
Plug MK-101 into the GFCI



(C)  
Plug the GFCI into the Power source \*

**SET CUTTING DEPTH**



**CAUTION**

When loosening the Cutting Head Adjusting Knob, the Cutting Head will pivot down unless held.



(A)  
Loosen Cutting Head Knob and move cutting head down



(B)  
Set cutting depth approximately 1/4 to 1/2 inch below the surface of the Movable Cutting Table



(C)  
Ensure the Adjusting Knob is tight

## CUTTING STRAIGHT EDGES

**CAUTION** **DO NOT FORCE THE TOOL.** It will do the job better and safer at the rate for which it was designed.

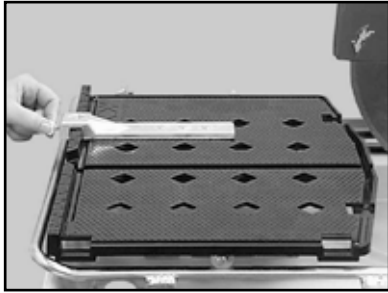

(A)  
Loosen the Adjustable Cutting Guide retaining thumbscrew

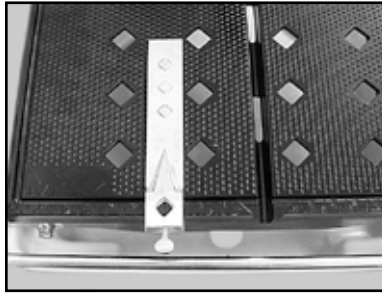

(B)  
Position the Adjustable Cutting Guide to desired cut length

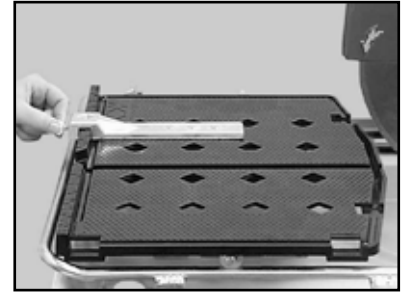

(C)  
Tighten the retaining thumbscrew

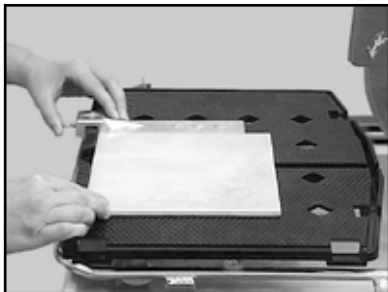

(D)  
Place the tile against the Ruler/Stop and Cutting Guide. Turn the motor ON

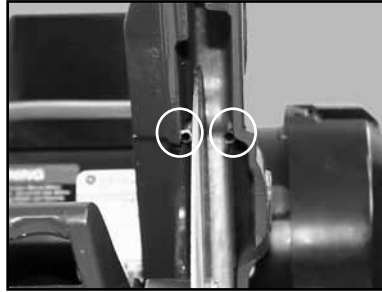

(E)  
Verify proper cooling flow on both sides of the blade (See Maintenance Section to increase/decrease flow)

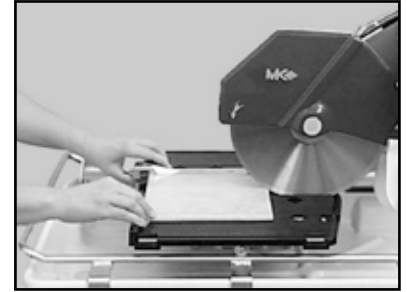

(F)  
Perform the cut. Turn the motor OFF when work is complete



## DIAGONAL CUTTING

**NOTE:** To cut diagonal, the Dual 45° Flat Angle Guide (MK Diamond Part No. 134557-MK) should be used.

**CAUTION** DO NOT FORCE THE TOOL. It will do the job better and safer at the rate for which it was designed.

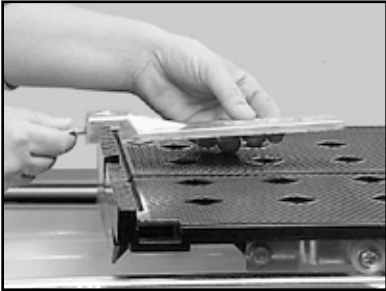

(A)  
Remove the Adjustable  
Cutting Guide

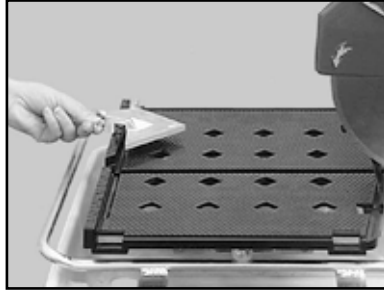

(B)  
Place the Dual 45° Flat Angle  
Guide on the Ruler/Stop

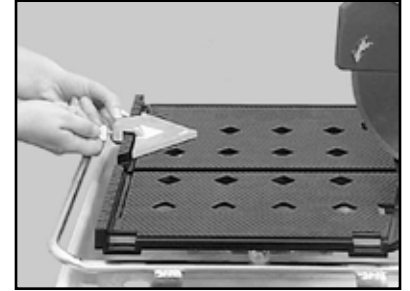

(C)  
Position the Dual 45° Flat  
Angle Guide and tighten the  
retaining thumbscrew

**NOTE:** If Cutting the tile in two equal halves, align the tile in the V-notch of the Movable Cutting Table Ruler/Stop.

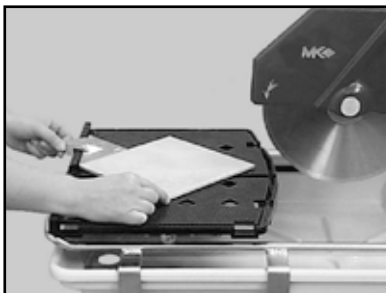

(D)  
Position the tile against the  
Dual 45° Flat Angle Guide and  
the Ruler/Stop. Turn the motor  
ON

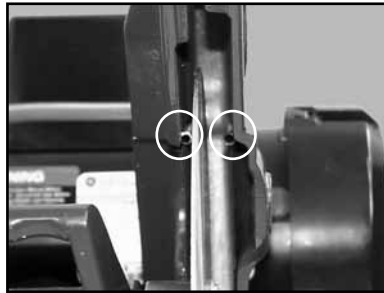

(E)  
Verify proper cooling flow on  
both sides of the blade (See  
Maintenance Section to in-  
crease/decrease flow)

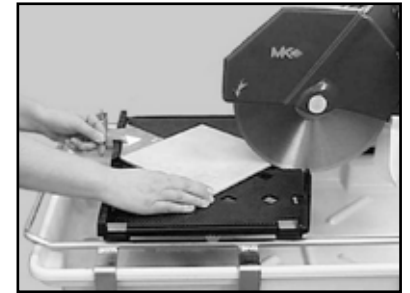

(F)  
Perform the cut. Turn the motor  
OFF when work is complete

**45° MITER CUTTING**

**NOTE:** To cut 45° Miters, the 45° Bullnose Miter Guide (MK Diamond Part No. 134585-MK) should be used.



**CAUTION DO NOT FORCE THE TOOL.** It will do the job better and safer at the rate for which it was designed.

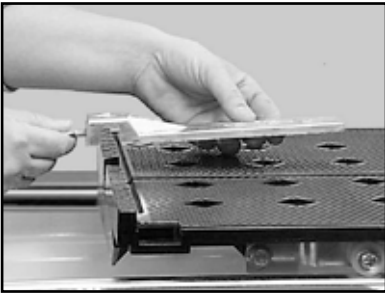

(A)  
Remove the Adjustable  
Cutting Guide

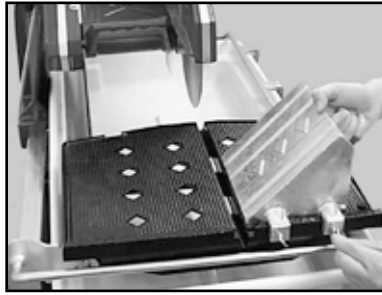

(B)  
Place the 45° Miter  
Guide on the Ruler/Stop

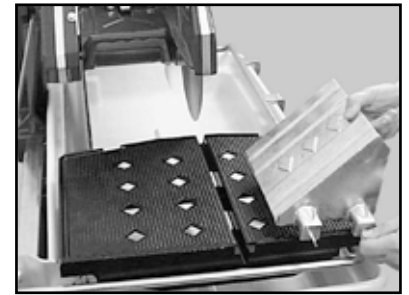

(C)  
Position the 45° Miter  
Guide and tighten the retaining  
thumbscrew

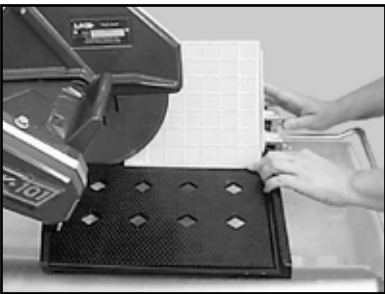

(D)  
Position the tile on the 45°  
Miter Guide and the  
Ruler/Stop. Turn the motor ON

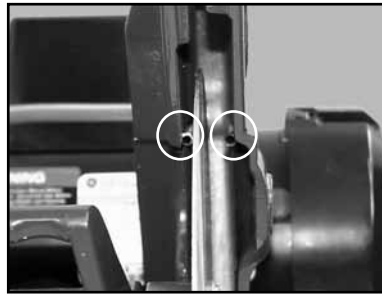

(E)  
Verify proper cooling flow on  
both sides of the blade (See  
Maintenance Section to in-  
crease/decrease flow)



(F)  
Perform the cut. Turn the motor  
OFF when work is complete



## OFF-ANGLE CUTTING

**NOTE:** To cut angles other than 45° angles or Miters, a 90° Protractor (MK Diamond Part No. 134569-MK) should be used.



**CAUTION DO NOT FORCE THE TOOL.** It will do the job better and safer at the rate for which it was designed.

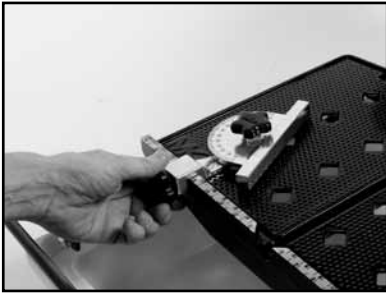

(A)

Place the 90° Protractor on the Ruler/Stop

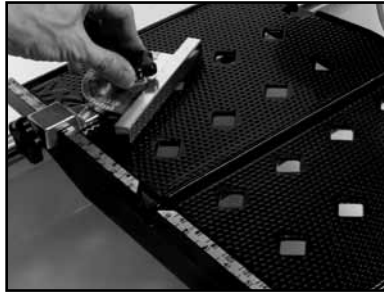

(B)

Set the desired angle and tighten the thumbscrew and tighten retaining thumbscrews

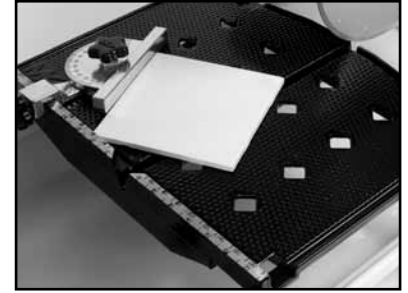

(C)

Position the tile against the 90° Protractor and the Ruler/Stop

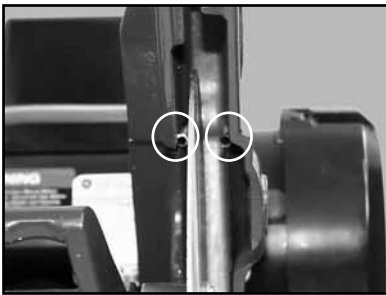

(D)

Turn the motor ON. Verify proper cooling flow on both sides of the blade



(E)

Perform the cut. Turn the motor OFF when work is complete

## ADJUSTING THE CUTTING HEAD

**⚠ CAUTION** The Cutting Head is heavy. Care must be used when changing the position of the Cutting Head.



(A)  
Remove the blade and then  
Adjusting Knob



(B)  
Remove the Cutting Head from  
the rear pivot hole



(C)  
Move Cutting Head Stop to  
down position



(D)  
Install the Cutting Head onto the  
front pivot hole



(E)  
Install the Adjusting Knob

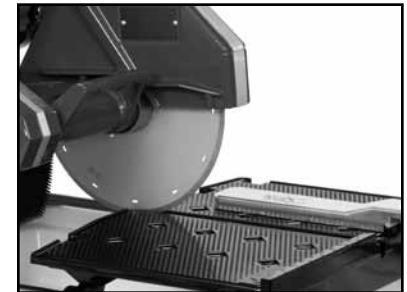

(F)  
Install Diamond Blade. Set  
cutting depth approx. 1/4 to 1/2  
inch below the surface of the  
Movable Cutting Table

**NOTE:** For small tiles (6" tile or smaller) the Cutting Head should be in the rear pivot hole and the Post should be in the forward post retaining hole. For large tiles and maximum cutting length, the Cutting Head should be in the front pivot hole and the Post should be in the rear post retaining hole.

**NOTE:** Move Cutting Head Stop in upward positions when using rear pivot hole and in the down position when using front pivot hole.



For maximum cutting length,  
the Cutting Head should be  
in the front pivot hole and the  
Post should be in the rear post  
retaining hole.

**ADJUSTING THE POST FOR MAXIMUM CUTTING LENGTH**

**⚠ CAUTION** The Cutting Head and Post are heavy. Care must be used when changing the position of the Cutting Head.

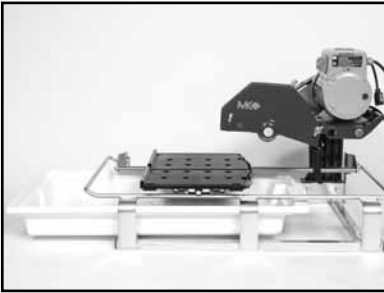

(A)  
Remove Water Basin



(B)  
Remove the Cutting Head (See  
Adjusting the Cutting Head)



(C)  
Loosen the Retaining Bolts.

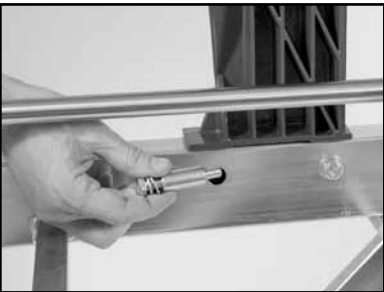

(D)  
Remove both the Standoffs and  
Retaining Bolts.

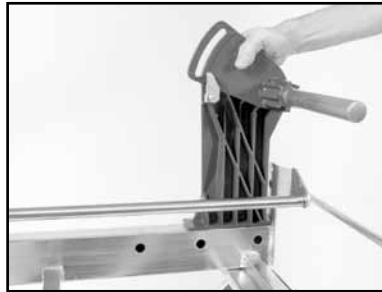

(E)  
Relocate the Post to the rear  
Post retaining holes. Insert  
Standoffs and Retaining Bolts



(F)  
Secure the Post Support by  
tightening Retaining Bolts.



(G)  
Install the Cutting Head in rear  
Pivot Hole (See Adjusting the  
Cutting Head)

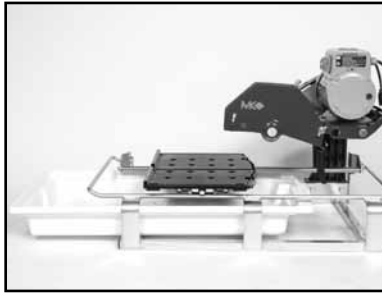

(H)  
Install the Water Basin and  
blade

- NOTE:**
1. If an external water source was used, steps A through C may be skipped.
  2. Dispose of waste water in accordance with applicable Federal, State and Local laws.



(A)

Clean the Water Pump suction of all debris. Refer to water pump manual.



(B)

Place the Water Pump in an external container

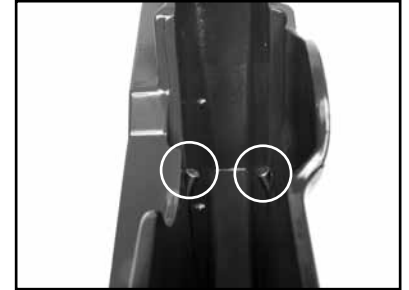

(C)

Run the MK-101 until clear water is seen at the blade cooling ports (Approx. 1 min.)



**CAUTION** Ensure the saw is disconnected before completing the remainder of the cleanup process.

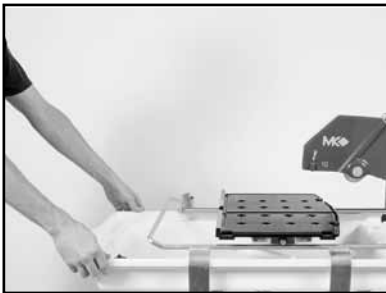

(D)

Remove the Water Basin and clean.



(E)

Clean the Movable Cutting Table Roller Wheel and Frame Support



(F)

Clean the remainder of the MK-101



**CAUTION** Ensure water is not forced into the motor casing when cleaning.

**NEW MAINTENANCE**

---

Perform the following after initial purchase and operation of the MK-101.



(A)

Check and adjust V-belt tension following 1st 48 hours of operation (See V-belt Inspection)

**MAINTENANCE FOLLOWING USE**

---

To extend the life of the MK-101, the following procedure should be performed after each use. Lubricate all points listed below with light oils such as, 3 in 1, WD-40, etc.



(D)

Lubricate the Guide Bar and the Roller Wheel Assembly

**MONTHLY MAINTENANCE**

The following maintenance should be performed Monthly.



(A)  
Remove the Diamond Blade



(B)  
Lubricate the Outer Flange  
and Retaining-nut

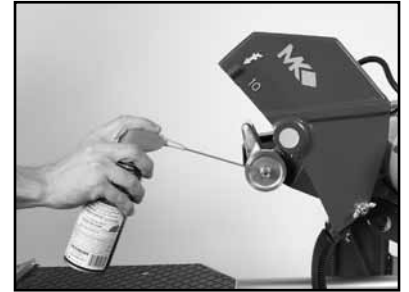

(C)  
Lubricate the Inner Flange



(D)  
Verify the Roller Wheel  
Assembly is tight and in  
good condition.



(E)  
Verify all motor mounting  
Bolts are tight



(F)  
Verify the Motor Adjustment  
Strap is tight

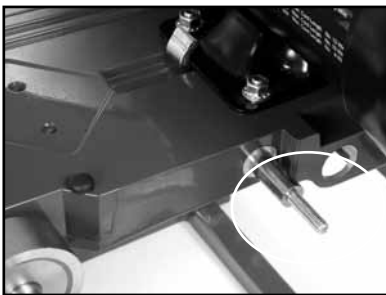

(G)  
Lubricate the Blade Guard  
Pivot Shaft



(H)  
Remove the Cutting Head (See  
Adjusting the Cutting Head)



(I)  
Lubricate the Cutting Head  
Adjustment Knob



(J)

Lubricate the Cutting Head  
Adjustment Knob retaining  
holes

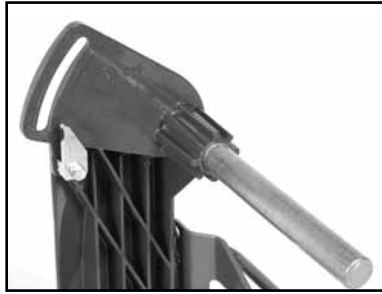

(K)

Lubricate the Cutting Head  
Pivot Shaft

## FLOW ADJUSTMENT

---

**NOTE:** If flow to the diamond blade requires adjustment, perform the following actions.

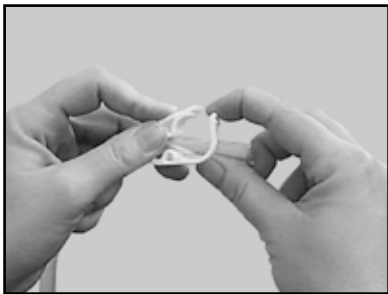

(A)

Increase cooling flow by releas-  
ing the Flow Adjusting Clamp

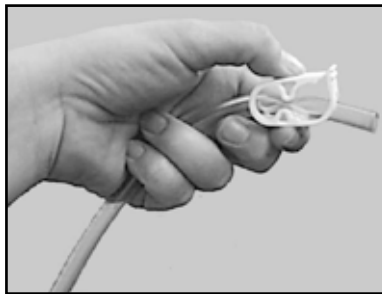

(B)

Reduce cooling flow by  
pressing down on the Flow  
Adjusting Clamp



## BLADE DRESSING

Like most cutting instruments, a diamond blade performs best when it is dressed. Over time and use, diamonds on the outer edge of the blade will become smoothed or "glazed" over. This will reduce grinding efficiency and may cause the blade to "wander" or bend giving the illusion of an alignment problem. When this occurs, the blade will need to be dressed. The diamond blade can be dressed using the MK Dressing Stick (part number 152972) and by following the steps below.



(A)

Cut the Dressing Stick 7 or 8 times to dress the Blade

## DIAMOND BLADE CHANGE OUT

**NOTE:** When installing the Retaining Screw, do not "cross-thread" and DO NOT over tighten the screw.



(A)

Locate the Shaft Lock push button on the underside of the Cutting Head



(B)

Remove Retaining Nut and Outer Flange, depress and hold the Shaft Lock hold button and loosen

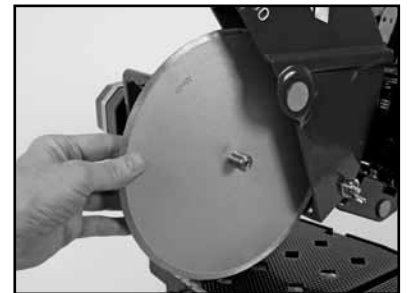

(C)

Remove the Diamond Blade

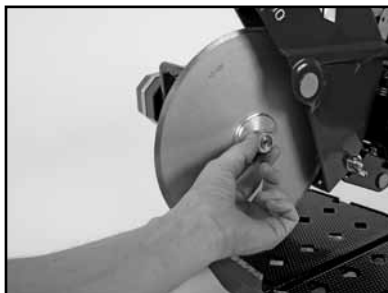

(D)

Install the new Diamond Blade onto Blade Shaft. Install Outer Flange and Retaining Nut



(E)

Verify the Blade is seated on the Blade Shaft and direction of rotation is correct



(F)

Depress and hold the Shaft Lock button and tighten Retaining Nut



## **BELT INSPECTION, ADJUSTMENT AND REPLACEMENT**

MK-101 is designed with a power transmission V-belt. In order to ensure the MK-101 operates at peak efficiency, the V-belt should be inspected monthly, and change if the V-belt shows damage and/or excessive wear.

**NOTE:** 1. When a new belt is installed, it should be inspected and re-tensioned after the first forty-eight (48) hours of operation.

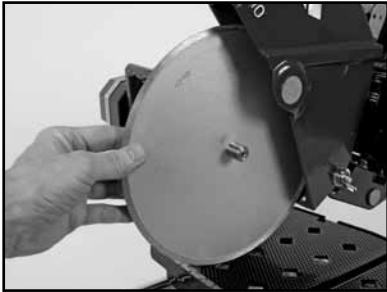

(A)  
Remove the Diamond Blade



(B)  
Remove the Cutting Head (See  
Adjusting the Cutting Head)



(C)  
Remove the two top Belt Guard  
Bolts



(D)  
Remove Belt Guard bottom bolt



(E)  
Inspect the Micro-V Belt for  
cracks, fraying, separation and  
wear. Go to step H if replacement  
is required

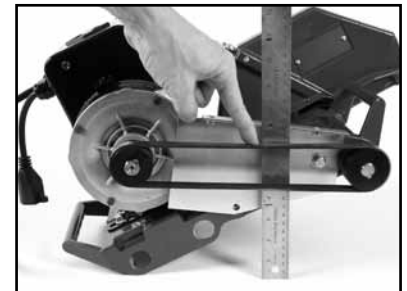

(F)  
Check belt for proper tension. If tension  
correct, go to step Q (proper tension  
should be 1/8-inch  
deflection)



(G)  
Loosen the two front motor  
mounting bolts. If re-tensioning  
only, go to step N



(H)  
Loosen the two back motor  
mounting bolts



(I)  
Loosen the Motor Adjustment Strap

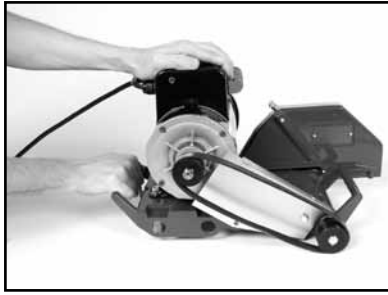

(J)  
Push the motor toward the front  
of the Cutting Head to loosen  
the Micro-V Belt

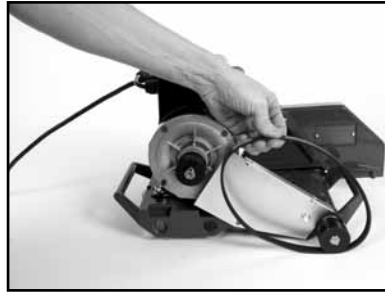

(K)  
Remove the Micro-V Belt



(L)  
Install the new Micro-V Belt  
(MK Diamond Part No. 158194)



(M)  
Verify the Micro-V Belt is seated  
in the grooves of both pulleys



(N)  
Tighten the Motor Adjustment  
Strap to remove slack

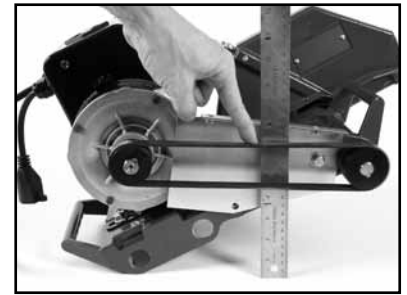

(O)  
Check Micro-V Belt tension  
(proper tension 1/8-inch) Repeat  
steps N and O until proper Micro-  
V Belt tension is achieved



(P)  
Tighten the four motor  
mounting bolts



(Q)  
Install the Belt Guard

**BLADE WILL NOT CUT PROPERLY**

(A)

Check for Smoothness or "Glazing" (See Blade Dressing Section)

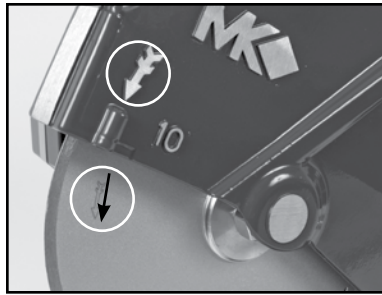

(B)

Check for proper blade rotation. Ensure arrow engraved on blade matches the directional arrow on blade guard



(C)

Ensure the Blade Core is not bent. Verify the blade is correct for the material being used

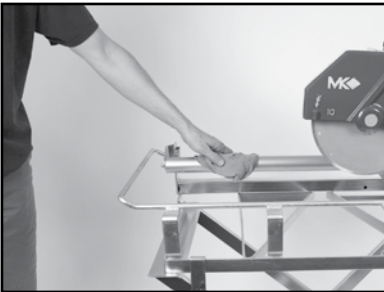
**MOVABLE CUTTING TABLE DOES NOT MOVE CORRECTLY**

(A)

Check the Guide Bar and Frame for cleanliness - clean if dirty

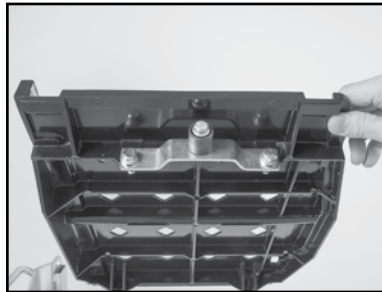

(D)

Verify the Roller Wheel Assembly is tight and in good condition.

## COOLING FLOW

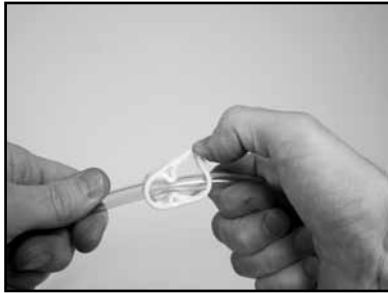

(A)  
Check cooling flow Adjusting  
Clamp open

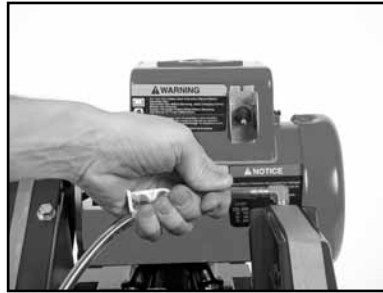

(B)  
Remove the Cooling Transfer  
Tube from the Blade Guard inlet



(C)  
Place Pump into a bucket of  
water and check flow



(D)  
Remove the Cooling Transfer  
Tube and check flow



(E)  
Inspect and clean pump. See  
pump manual



(F)  
Remove the Blade Guard In-  
take Fitting and check

**NOTE:** "Rodding" cooling channels is performed by inserting a small wire rod through the cooling inlet on top of the Blade Guard and directing the rod out through each of the cooling flow tubes located on the underside of the Blade Guard. The cooling channels should be "rodded" until all ports are free of foreign debris.



(G)  
Remove the Cooling Chan-  
nel cover screws



(H)  
Rod Cooling Channels and  
recheck flow

**BLADE STOPS TURNING**

---



(A)

Allow motor to cool and depress motor Overload Reset Switch

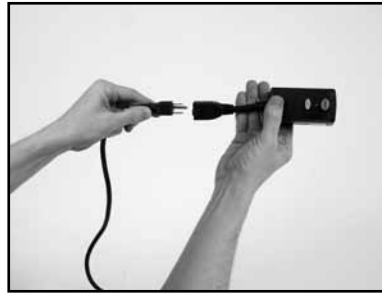

(B)

Verify all plugs fully installed.  
Check Ground Fault Circuit Interrupter

**NOTE:** Verify circuit breaker at least 20 amps - if not, move to 20-amp circuit.  
Verify circuit breaker not tripped. If tripped, reset once.  
Check power source voltage is 120V - if not 120V, move to another circuit.

Saw Assembly  
Part# 151991

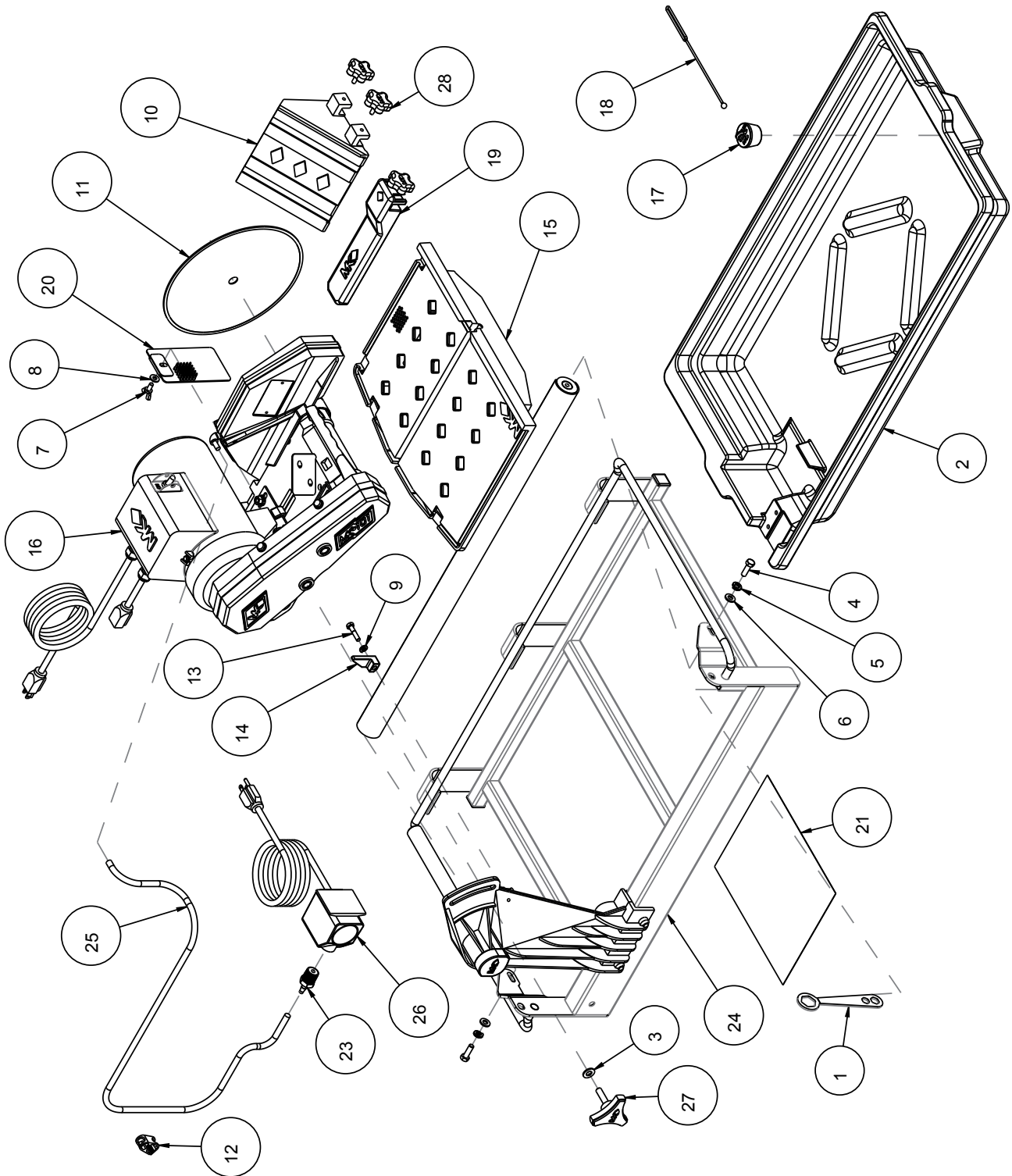

## Saw Assembly Part# 151991

Item	Description	Part #	Qty
1	WRENCH, TILE SAW NUT 15/16	134684	1
2	PAN, PLASTIC MK-101	150634	1
3	WASHER, FLAT, SAE, 3/8	150923	1
4	SCREW, HEX HD, 5/6 - 18 X 1	151743	2
5	WASHER, LOCK, SPLIT, 15/16	151747	2
6	WASHER, FLAT, SAE, 5/16	151754	2
7	SCREW, WING, 1/4 20 X 1/2	151888	1
8	WASHER, FLAT, SAE, 1/4	152915	1
9	WASHER, LOCK, SPLIT 1/4	152591	1
10	CASTING, ACC BULLNOSE LRG - COMP	153201	1
11	MK-100 10 X 060 X 5/8	154380	1
12	CLAMP, HOSE, 1/4 - 1/2 FLOW	154394	1
13	SCREW, HEX HD 1/4 - 20 X 1-1/4	157145	1
14	STOP, CUTTING HEAD	157728	1
15	ASSY, DC TABLE, MK-101	158477	1
16	ASSY, DC CUTTING HEAD, MK-101	158478	1
17	DRAIN PLUG, W/RING	159529	1
18	STRAP, 9" DRAIN PLUG	159530	1
19	RIP GUIDE, LARGE DIE CAST	159751	1
20	GUARD, SPLASH	160310	1
21	SHEET, WARNING LABELS, TILE SAW	166012	1
22	ASSY, CARTON, MK-101	166621	1
23	ADAPTER, 1/2 NPT X 1/4 BARB	168261	1
24	ASSY, FRAME & POST, MK-101	170476	1
25	HOSE, VINYL, 1/4 X 3/8 (6.0')	132951	1
26	PUMP, WATER 115V/60HZ UL/CSA	151271-VP	1
27	KNOB, TRI PLASTIC MK-660 1 - 1/2	156770-02	1
28	KNOB, RUBBER, 1/4 - 20 X 3/4" LONG	159428-1	2



Frame Assembly  
Part# 170476

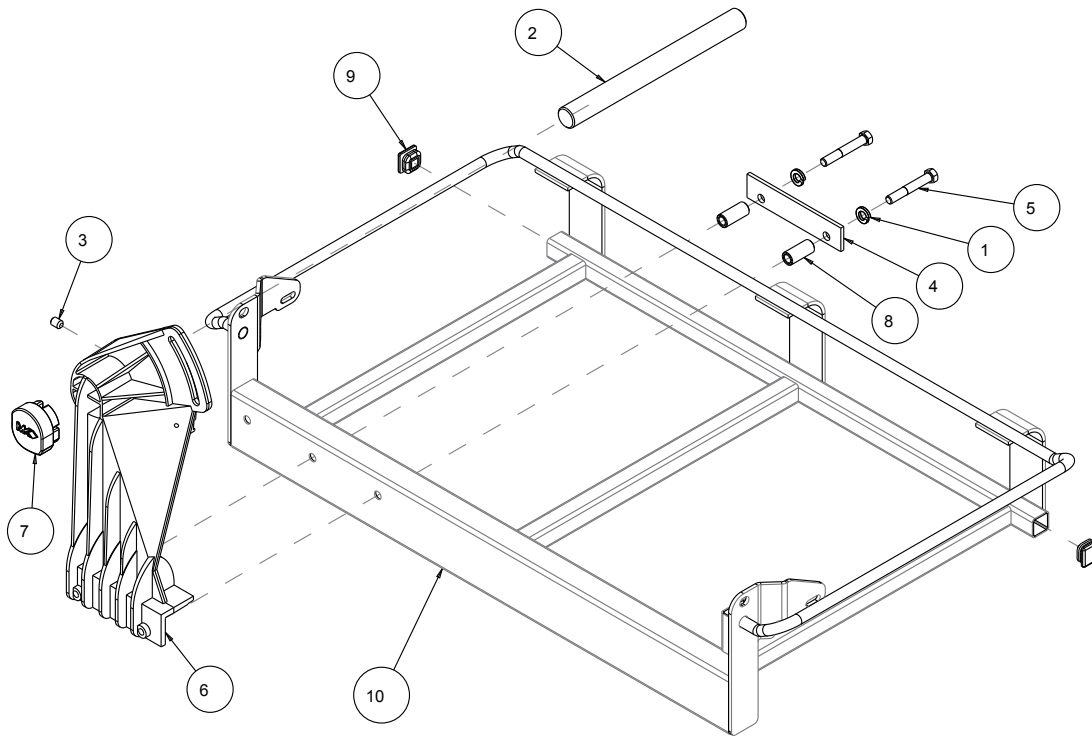
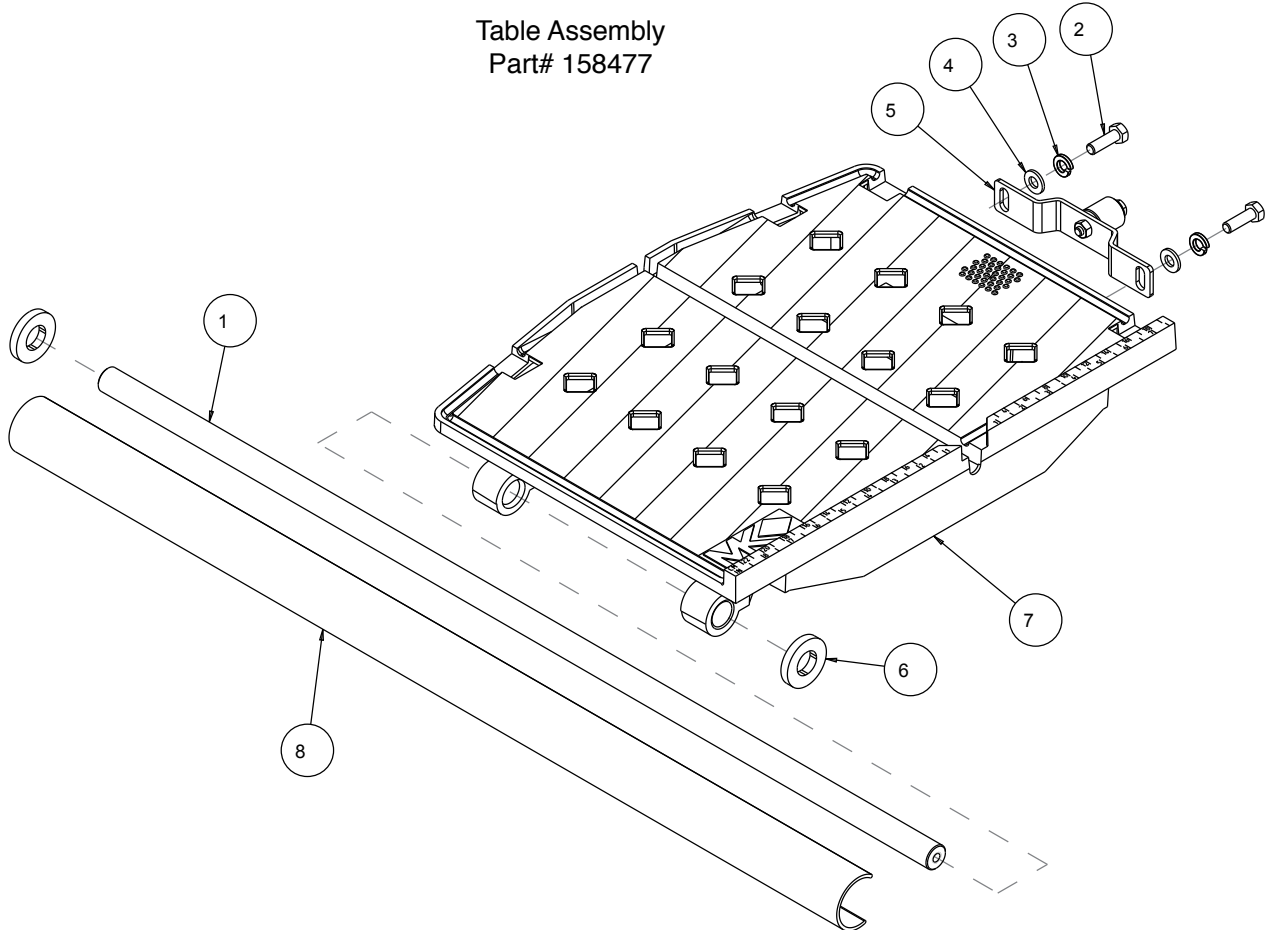

Table Assembly  
Part# 158477





## Frame Assembly Part# 170476

Item	Description	Part #	Qty
1	WASHER, LOCK, SPLIT, 3/8	150925	2
2	SHAFT, 10.63 PIVOT	153254	1
3	SCREW, SET, SOC, CUPT, 3.8 - 16 X 1/2	153710	1
4	PLATE, PRESSURE	155671	1
5	SCREW, 3/8 16 X 2 -1/2 HEX HEAD CAP	156030	2
6	CASTING, POST, DC, 101 MKRED-COMP	158438	1
7	POST COVER, PLASTIC	160157	1
8	SPACER, 5.8 X .385 X 1.4	160654	2
9	PLUG, PLASTIC, 1 SQ- 14 - 20 GA	160727-1	2
10	FRAME, 10" TILE SAW, 18" RIP	168021	1

## Table Assembly Part# 158477

Item	Description	Part #	Qty
1	BAR, GUIDE PLATED MK-101	134759	1
2	SCREW, HEX HD, 5/16 - 18 X 1	151743	2
3	WASHER, LOCK, SPLIT, 5/16	151747	2
4	WASHER, FLAT, SAE, 5/16	151754	2
5	ASSY, WHEEL BRKT TSAW	151756	1
6	SPACER, GUIDE BAR COVER, COMMON	152393	2
7	CASTING, TABLE MK-100 COMP	157660	1
8	COVER, GUIDE BAR, 120 DEG	158403	1

Cutting Head  
Part# 158478

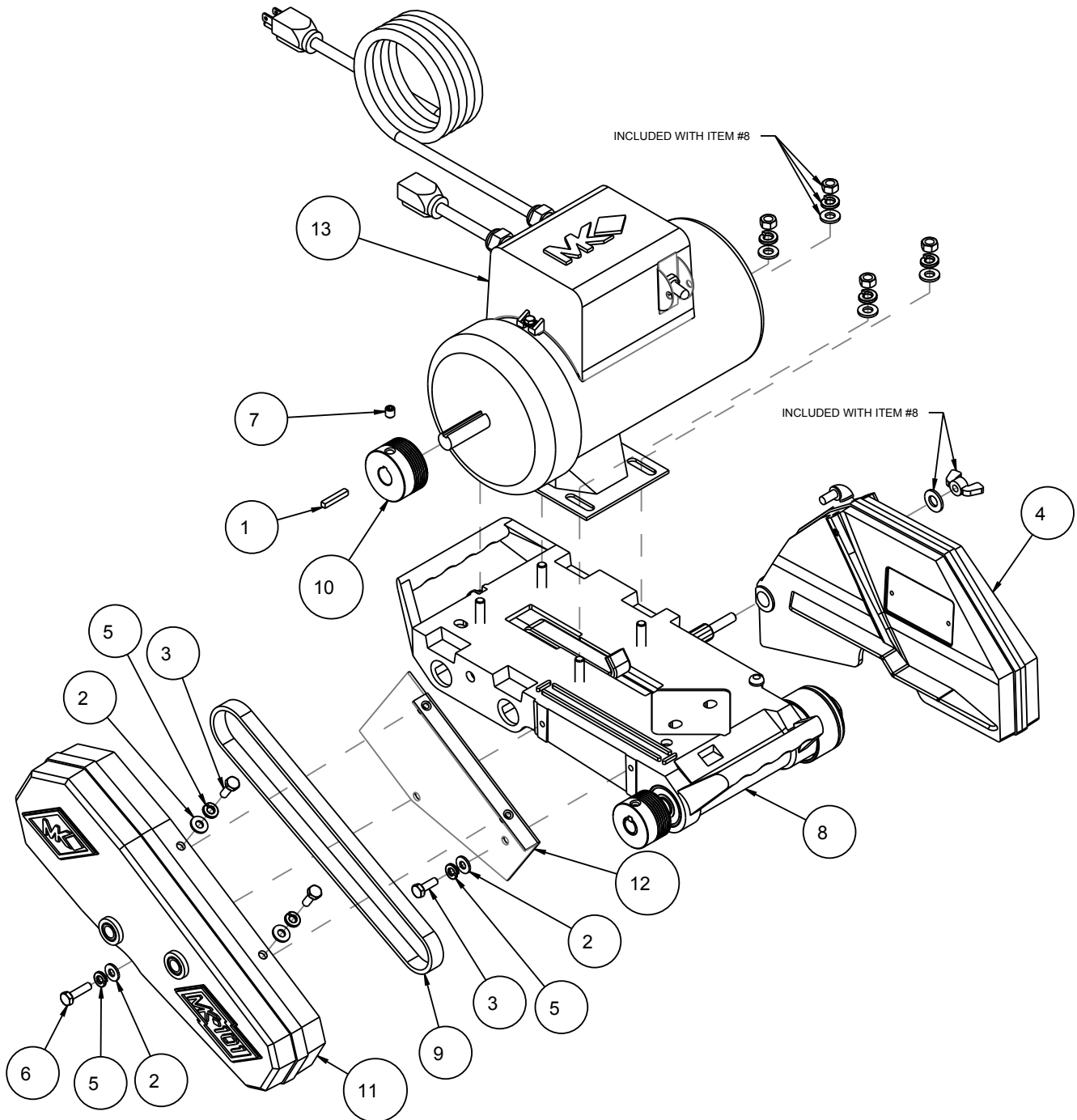

## Cutting Head Part# 158478

Item	Description	Part #	Qty
1	KEY, 3/16 SQ X 1-1/8	150344	1
2	WASHER, 1/4 SAE FLAT	151915	4
3	SCREW, HEX HD, 1/4 -20 X 3/4	152370	3
4	ASSY, BLADE GUARD, 101	152582	1
5	WASHER, 1/4 SPLIT LOCK	152591	4
6	SCREW, HEX HD TAP, 1/4 - 20 X 1	152676	1
7	SCREW, 5/16 -18 X 3/8 SOCKET HEAD SET	157083	1
8	ASSY, SBU, CUTTING HEAD MK-101	158191	1
9	BELT, 6J260	158194	1
10	PULLEY, 6J19 X 5/8 BORE	158199	1
11	CASTING, 101 BELT GUARD-COMP	158319-01	1
12	BRACKET, INNER BELTGUARD	158611	1
13	MTR, 1-1/2 HP, 115V, 60HZ-VP	168022G	1

Cutting Head Assembly  
Part# 158191

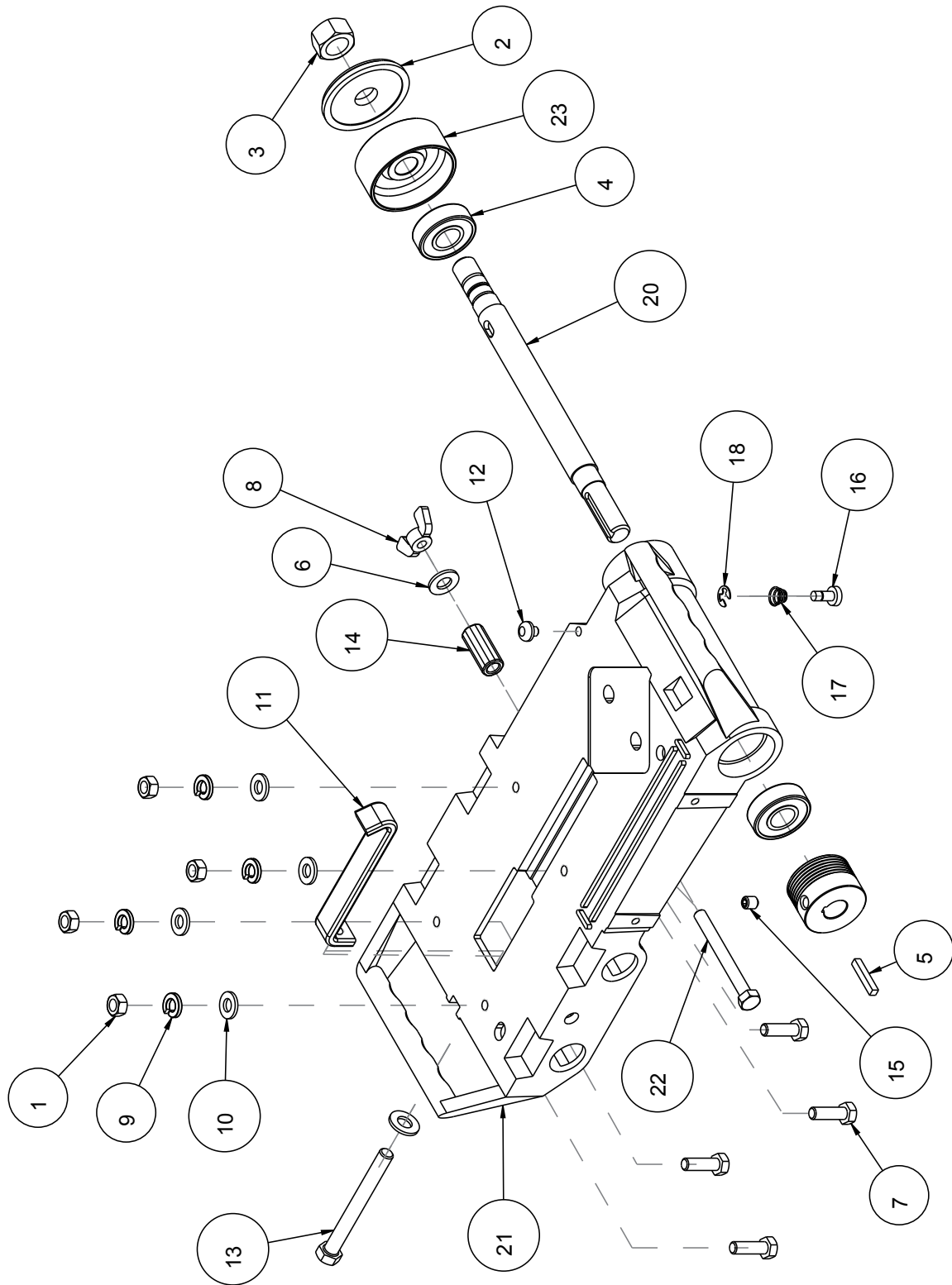

## Cutting Head Assembly Part# 158191

Item	Description	Part #	Qty
1	NUT, HEX, 5/16 - 18	101196	4
2	FLANGE, OUTER, 2 - 3/8	135830	1
3	NUT, HEX, 5/8 18	135848	1
4	BEARING, BALL, 17 X 40 X 12MM	137711	2
5	KEY, 3/16 SQ X 1 - 1/8	150344	1
6	WASHER, FLAT, SAE, 3/8	150923	2
7	SCREW, HEX HEAD, 5/16 - 18 X 1	151743	4
8	NUT, WING, NYLK, 5/16 - 18	151746	1
9	WASHER, 5/16 SPLIT LOCK	151747	4
10	WASHER, 5/16 SAE FLAT	151754	4
11	STRAP, 1 INCH MOTOR ADJ.	152673	1
12	BUMPER, RUBBER, 1/2 DIA.	152674	1
13	BOLT, 3/8 - 16 X 3-1/2 HEX HEAD TAP	153147	1
14	PIVOT, BLADE GUARD	153208	1
15	SCREW, 5/16 - 18 X 3/8 SOCKET HEAD SET	157083	1
16	BUTTON, SHAFT LOCK	158200	1
17	SPRING, BLADE SHAFT LOCK	158201	1
18	RING, 1/4 E-STYLE RETAINING	158202	1
19	PULLEY, 6J17 X 5/8 BORE	158214	1
20	SHAFT, BLADE	158222	1
21	CASTING, 10" CTTG HEAD - COMP	158224	1
22	SCREW, HEX HD, TAP, 5/16 - 18 X 3	162473	1
23	FLANGE, Ø 2 - 3/8 INNER	162758	1

Blade Guard Assembly  
Part# 152582

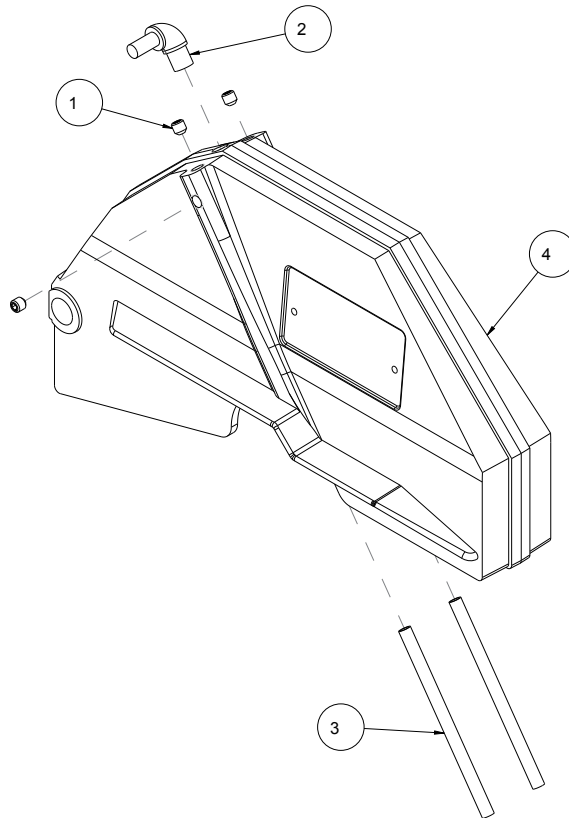

Roller Wheel Assembly  
Part# 151756

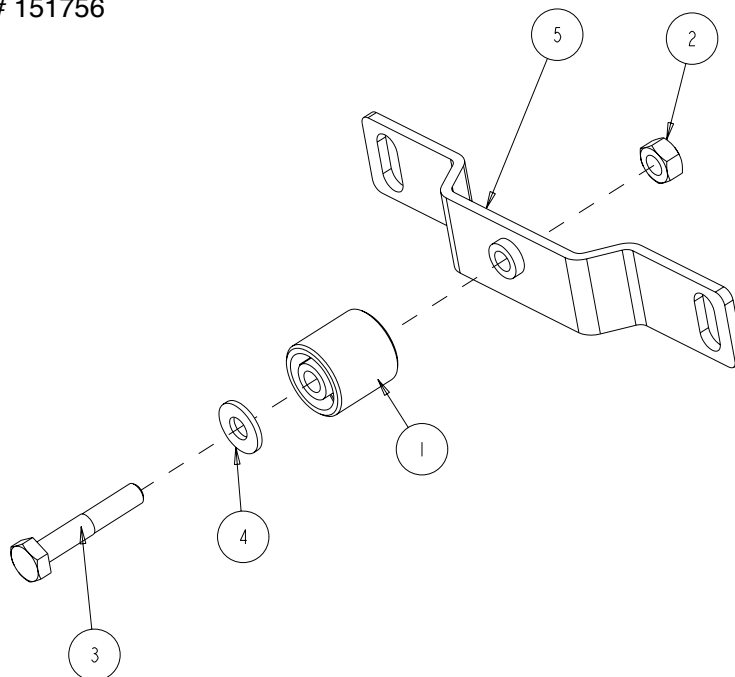









**Blade Guard Assembly Part# 152582**

<b>Item</b>	<b>Description</b>	<b>Part #</b>	<b>Qty</b>
1	SCREW, 5/16 - 18 X 1/2 SOCKET HD SET	152607	3
2	ELBOW, 1/8MNPT X 1/4 BARB, 90 DEG	154652	1
3	TUBE, WATER	155389	2
4	CASTING, 101 BLD GUARD-DC-COMP	162481	1

**Roller Wheel Assembly Part# 151756**

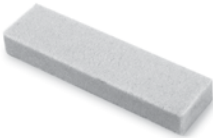
<b>Item</b>	<b>Description</b>	<b>Part #</b>	<b>Qty</b>
1	WHEEL, ROLLER	151799	1
2	NUT, HEX, 1/4 - 20	151893	1
3	SCREW, HEX HEAD 1/4 -20 X 1-1/2"	151914	1
4	WASHER, 1/4 SAE FLAT	151915	1
5	BRACKET, ROLLER WHEEL	154021	1



ACCESSORIES:			
ITEM	NUMBER	DESCRIPTION	
1.	137166	MK-200. 10 X 5/8 ARBOR Premium grade Diamond Blade for smooth, chip-free cutting on tile.	
2.	128074	MK-215, 10 X 5/8 ARBOR Supreme grade diamond blade for hard materials	
3.	153252	MK-315, 10 X 5/8 ARBOR Supreme super hi-rim diamond blade	
4.	134577-MK	DUAL 45° FLAT ANGLE GUIDE	
6.	134569-MK	90° PROTRACTOR	
7.	152792	DRESSING STONE	
8.	152610	GROUND FAULT CIRCUIT INTERRUPTER	
9.	168244	FOLDING STAND	
10.	169243	STAND W/CASTERS	



## **ORDERING INFORMATION**

---

You may order MK Diamond products through your local MK Diamond distributor or, you may order direct from MK Diamond.

When ordering direct from MK Diamond, please have the following information ready before calling:

- The Model Number of the saw
- The Serial Number of the saw
- Where the saw was purchased and when
- The Part Number for the part(s) being ordered
- The Part Description for the part(s) being ordered

**NOTE:** There is a \$25.00 minimum order when ordering direct from MK Diamond. A \$6.00 charge will be added to orders having a net billing value under \$50.00. All purchases must be made using VISA, MasterCard or American Express.

All parts may be ordered by calling toll free to – 800 421-5830 or 310 539-5221 and asking for Customer Service. For technical questions, call – 800 474-5594.

## **RETURN MATERIALS POLICY**

---

To expedite the service relative to the return of a product purchased through MK Diamond, please observe the following:

**NOTE:** When returning all items, they must have been purchased within the previous twelve (12) months.

- Have the Model Number of the saw
- Have the Serial Number of the saw
- Have the location of where the saw was purchased
- Have the date when the saw was purchased
- Contact Customer Service for approval to return the item(s)
- Obtain a Returned Goods Number (RGA) authorizing the return
- Follow the packaging instructions in the following section
- Ensure your item(s) are prepaid to the destination

For returned items, call toll free to – 800 421-5830 or 310 539-5221 and ask for Customer Service. For technical questions, call – 800 474-5594 or 310 257-2845.

## **PACKAGING INSTRUCTIONS**

---

- Remove the Cutting Head and Support Angle Assembly
- Dry the saw before shipping
- When packing, include the following: Saw, Diamond Blade, Blade Guard and Support Angle Assembly and Adjustable Cutting Guide (Other Accessories are not required)
- Package the unit in its original container or one of comparable size (do not ship the unit partially exposed)
- Ensure all parts are secured in the packaging to prevent moving

## **AUTHORIZED SERVICE CENTERS**

---

For quicker repair time, you may contact MK Diamond Customer Service, toll free, at 800 421-5830 or 310 539-5221 for the Authorized Service Center closest to you or visit our web site at [www.mkdiamond.com](http://www.mkdiamond.com). For technical questions, call – 800 474-5594.

**CONTACT:**

Please contact MK Diamond Products, Inc. Customer Service Department with any questions you might have regarding distributors, parts or service.

Telephone: **(800) 421-5830**

Fax: **(310) 539-5158**

E-mail: **Customer\_Service@MKDiamond.com**

Customer Service Hours: **Monday through Friday, 6AM-4PM PST**

**MK Diamond Products, Inc.**

**1315 Storm Parkway**

**Torrance, CA 90501**

**MK DIAMOND PRODUCTS, INC. LIMITED WARRANTY**

MK DIAMOND PRODUCTS, INC. will guarantee every machine they build, to be free from defects in material and workmanship for (1) one year from date of purchase. The obligation of MK DIAMOND PRODUCTS, INC. under this warranty is limited to the repair or replacement of any parts which, under normal use, prove to be defective in material or workmanship. The parts involved or the unit in question should be returned to MK DIAMOND PRODUCTS, INC. or to a point designated by us, transportation prepaid.

This warranty does not obligate us to bear the cost of labor or transportation charges in connection with replacement or repair of defective parts. Likewise, it shall NOT apply to any unit which has been subjected to misuse, neglect or accident. This warranty does NOT apply to any machine which has been repaired or altered outside our factory.

This warranty does NOT obligate MK DIAMOND PRODUCTS, INC., with respect to items not of our manufacture, such as engines, motors, hydraulics, etc., which are subject to their own guarantees and warranties.

We shall in no event be liable for consequential damages or contingent liabilities arising out of failure of any equipment or parts to operate properly.

**© COPYRIGHT 2013, MK DIAMOND PRODUCTS, INC. ALL RIGHTS RESERVED.**

The MK Diamond logo is a registered trademark of MK Diamond Products, Inc. and may not be used, reproduced, or altered without written permission. All other trademarks are the property of their respective owners and used with permission.

MK Diamond may have patents, patent applications, trade marks, copyrights of other intellectual property right covering this product in this document.

This manual MUST accompany the equipment at all times. This manual is considered a permanent part of the equipment and should remain with the unit if resold.

The information and specifications included in this publication were in effect at the time of approval for printing.

**MK-101 TILE SAW**  
**OWNER'S MANUAL & OPERATING INSTRUCTION**



**MK Diamond Products, Inc.**

MK Diamond Products, Inc.  
1315 Storm Parkway  
Torrance, CA 90501

Toll-Free: (800) 845-3729  
Phone: (310) 539-2221  
Fax: (310) 539-5158  
[www.mkdiamond.com](http://www.mkdiamond.com)