



Range Hoods

Installation Instructions, Maintenance, Use and Warranty

INSTRUCTIONS FOR MODELS:

W108,W110,W111,W112, W122,UR008, UR010, UR011,UR012,LRU08,
LRU10,LRU11,LRU12,LRU22,HDRU08,HDRU10,HDRU11



Intertek

IMPORTANT: READ AND SAVE THESE INSTRUCTIONS.
FOR RESIDENTIAL USE ONLY.

Revised July 2019

Disclaimer: Item purchased may be slightly different from the manual.

IMPORTANT SAFETY INSTRUCTIONS

WARNING: TO REDUCE THE RISK OF FIRE, ELECTRIC SHOCK, OR INJURY TO PERSONS, READ THE FOLLOWING:

- Use this unit only in the manner intended by the manufacturer. If you have questions, please contact the manufacturer.
- Before servicing or cleaning the unit, switch the power off and turn power off at the electrical panel and lock the service panel. This will prevent the power from accidentally turning on. If the service panel does not lock, secure a warning label, such as a tag, to the service panel.
- Installation work and electrical wiring must be done by a qualified professional(s) in accordance with all applicable codes, standards, and fire-rated constructions.
- Do not operate any fans with a damaged cord or plug. Discard the fan or return to an authorized service facility for further examination and/or repair.
- To prevent back draft, sufficient air is needed for proper combustion. Gas from the fuel burning equipment needs to exhaust through the flue (chimney). Follow the heating equipment manufacturer's guideline and safety standards such as those published by the National Fire Protection Association (NFPA), the American Society for Heating, Refrigeration and Air Conditioning Engineers (ASHRAE), and the local code authorities.
- When cutting, or drilling into walls or ceilings; be aware of electrical wires, piping, and other utilities.
- Ducted fans must always be vented outdoors.

CAUTION: For general ventilation use only. Do not use to exhaust hazardous or explosive materials and vapors.

CAUTION: To reduce the risk of fire and to properly exhaust air, be sure to duct air outside – DO NOT vent exhaust air into attics, crawl spaces, garages, or within walls and ceilings.

WARNING: TO REDUCE THE RISK OF A RANGE TOP GREASE FIRE, READ THE FOLLOWING:

- Never leave surface units unattended at high settings. Boil-over can cause smoke and grease to spill over that may ignite. Heat oils slowly on low or medium settings.
- Always turn range hood ON when cooking at high heat or when cooking food with high flames.
- Clean ventilation fans frequently. Grease should not be allowed to accumulate on fan or filter.
- Use proper pan size. Always use cookware appropriate for the size of the surface element.

WARNING: TO REDUCE THE RISK OF INJURY, IN THE EVENT OF A RANGE TOP GREASE FIRE, READ THE FOLLOWING:

- SMOTHER FLAMES with a close-fitting lid, cookie sheet or metal tray, then turn off the burner. BE CAREFUL TO PREVENT BURNS. If the flames do not go out immediately. EVACUATE AND CALL THE FIRE DEPARTMENT.
- NEVER PICK UP A FLAMING PAN – you may be burned.
- DO NOT USE WATER, including wet dishcloths or towels – a violent steam explosion will result.
- Use an extinguisher ONLY if:
 - You know you have a class ABC extinguisher, and you know how to operate it.
 - The fire is small and contained in the area where it started.
 - The fire department is being called.
 - You can fight the fire with your back to an exit.Based on “Kitchen Fire Safety Tips” published by NFPA

WARNING: To reduce the risk of fire or electrical shock, do not use this fan with any solid-state speed control device.

LOCATION REQUIREMENTS

IMPORTANT: Observe all governing codes and ordinances. Have a qualified technician install the range hood. It is the installer's responsibility to comply with installation clearances specified on the model/serial rating plate. Canopy hood's location should be away from strong draft areas, such as windows, doors, and strong heating vents. Cabinet opening dimensions that are shown must be used. Given dimensions provide minimum clearance.

ELECTRICAL REQUIREMENTS

Observe all governing codes and ordinances. Ensure that the electrical installation is adequate and in conformance with the National Electrical Codes, ANSI/NFPA 70 (latest edition), or CSA Standards C22.1-94, Canadian Electrical Code, Part 1 and C22.2 No. 0-M91 (latest edition), all local codes, and ordinances. If codes permit and a separate ground wire is used, it is recommended that a qualified electrician determine that the ground path is adequate.

A copy of the above code standards can be obtained from:

1 Batterymarch Park
Quincy, MA 02169-7471
CSA International
8501 East Pleasant Valley Road
Cleveland, OH 44131-5575

- 120 volt, 60 Hz, AC only.
- If the house has aluminum wiring, follow the procedure below:
 - o Connect a section of solid copper wire to the pigtail leads.
 - o Connect the aluminum wiring to the copper wire using special connectors and/or tools designed and UL listed for joining copper to aluminum. Follow the manufacturer's recommended procedure for the electrical connector. Aluminum/copper connection must conform to local codes and industry accepted wiring practice.
- Wire sizes and connections must conform to the rating of the appliance as specified on the model/serial rating plate. The model/serial plate is located behind the filter on the rear wall of the range hood.
- Wire sizes must conform to the requirements of the National Electrical Code, ANSI/NFPA 70 (latest edition), or CSA Standards C22. 1-94, Canadian Electrical Code, Part 1 and C22.2 No. 0-M91 (latest edition) and all local codes and ordinances.

VENTILATION REQUIREMENTS

General requirements

- Range hoods must be ventilated to the outdoors, except for non-vented (recirculating) installations.
- Do not ventilate the range hood into an attic or other enclosed areas.
- Do not use 4" (10.2 cm) laundry-type wall caps.
- The length of the range hood and the number of elbows should be kept to a minimum to provide maximum performance.

For the most efficient and quiet operation

- Use no more than three 90-degree elbow.
- Make sure there is a minimum of 24" (61 cm) of straight duct between the elbows if more than one elbow is used.
- Do not install two elbows together.
- Use clamps and tape to seal all joints in the vent system.
- The vent system must have a damper. If the roof or wall cap has a damper, do not use the damper supplied with the range hood.
- Use caulking to seal exterior walls or roof openings around the cap.
- The size of the vents should be uniform.

Cold Weather Installations

An additional back draft damper should be installed to minimize backward cold air flow. A thermal break should be installed to minimize conduction of outside temperatures as part of the vent system. The damper should be on the cold air side of the thermal break. The break should be as close as possible to where the vent system enters the heated portion of the house.

Makeup Air

Local building codes may require the use of makeup air systems, when using ventilation systems greater than specified CFM of air movement. The specified CFM varies from state to state. Consult your HVAC professional for specific requirements in your area.

Venting Method

To vent through a wall, a 90-degree elbow is needed. If exhaust ducting with a diameter of less than 5.91" (150 mm) or if flat ducting is used, the noise level of the range hood could increase and extraction will be less efficient.

Rear Discharge

A 90-degree elbow may be installed immediately above the hood.

Calculating Vent System Length

To calculate the length of the system you need, add the equivalent feet (meters) for all vent pieces used in the system.

INSTALLATION DIMENSION RECOMMENDATIONS

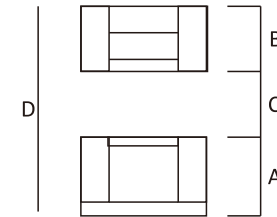

For undercabinet mount range hoods. Model: W108, W110, W111, W112, W122, UR008, UR010, UR011, UR012, UR022, LRU08, LRU10, LRU11, LRU12, LRU22, HDRU08, HDRU10, HDRU11

- A. Countertop Height.
- B. Hood height from ceiling to bottom of the range hood filter surface: $D - A - C = B$.
- C. 24" minimum from cooking surface up to 36" maximum for Electric/Induction range tops. 26" minimum from cooking surface up to 36" maximum for Gas range tops.
- D. Floor to ceiling height.

Prior to installation

- Unpack range hood and ensure all listed parts are in the box.
- It is recommended for the vent system to be installed before hood is installed.
- Before making cutouts, make sure there is proper clearance within the ceiling or walls for the exhaust vent.
- Some models may have foam protecting the motor, please remove, and discard this foam.
- Some models may have a protective Blue film on the filters (G), please remove, and discard this film.
- Determine which venting method to use: roof or wall.
- **It is recommended that a professional installer perform the range hood installation.**

Exhibit A

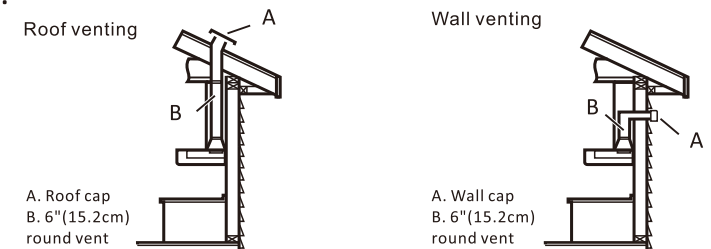

INSTALLATION INSTRUCTIONS for Undercabinet Range Hood

Models: W108, W110, W111, W112, W122, UR008, UR010, UR011, UR012, UR022, LRU08, LRU10, LRU11, LRU12, LRU22, HDRU08, HDRU10, HDRU11

Parts supplied

Note: The fasteners included may not be suitable to your cabinet. Please check with the installer on proper fasteners to be used based on the material makeup of your cabinet

- (A) Range Hood
- (B) Power cord for hard wiring, or Power cord with 3-prong plug, depending on model
- (C) 7" round air vent (attached to top of range hood)
- (D) (D) Optional 3-1/4" X 10" air vent (included in packaging). (6) #8 X 3/8" screw for securing air vent (screws are included in air vent packaging).
- (E) (2-3) Aluminum mesh filters or (2-3) Baffle filters, depending on model (attached to the bottom of the range hood)
- (F) Optional rear power cord exit (punch out)
- (G) (2) Easy installation bracket for frameless cabinet
 - a. (16) #8 X 5/8" wood screw
- (H) (2) Easy installation bracket for framed cabinet
 - a. (8) #8 X 5/8" wood screw
 - b. (8) #8 X 3/8" machine screw
- (I) Charcoal filters for non-ducted use (included in some models)
- (J) (2) Drywall Anchor and (2) 1-3/16 drywall anchor screw. **Optional use for securing range hood to wall if cabinet bottom is not stable enough to support range hood.**

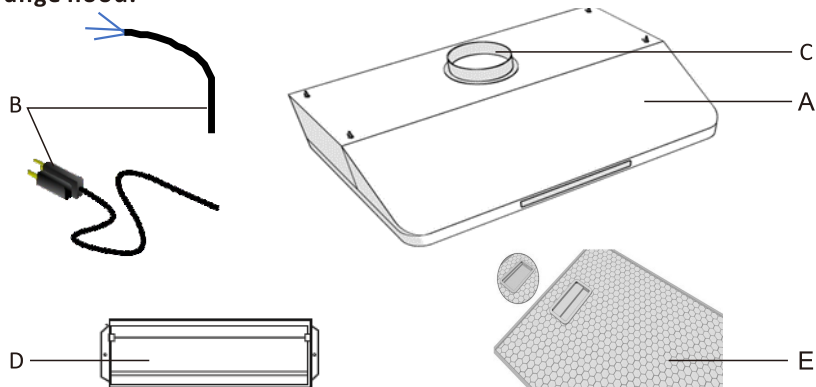

Backside of Range Hood

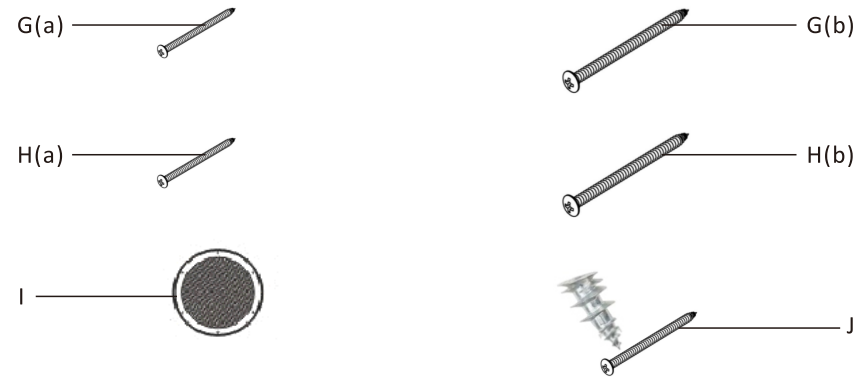

Parts not supplied

- Duct tape
- Duct work
- Electrical wire connectors (used for hard wired installation)

Ducting options (prior to installation)

Always wear safety glasses and protective gloves when handling the range hood.

There are four ducting options available with these models:

1. Ventilate out of your dwelling vertically by using the 7" round air vent (C) located on top of the range hood.
2. Ventilate out of your dwelling vertically by using the 3-1/4" X 10" air vent (D) that will be assembled to the top of range hood.
3. Ventilate out of your dwelling horizontally by using the 3-1/4" X 10" air vent (D) that will be assembled to the rear of range hood.
4. Recirculate the air (non-ducted) within your dwelling.

Ventilate out of your dwelling vertically by using the 7" round air vent (c) located on top of the range hood

1. Remove the (4) set screws from the air vent (C) that is attached to the top of the range hood and remove the air vent.

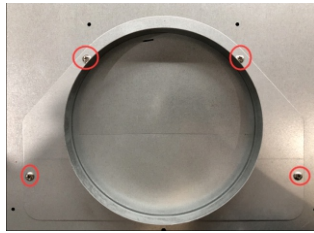

2. Using a flat head screwdriver and pliers, remove the 3-1/4" X 10" stainless-steel plate.

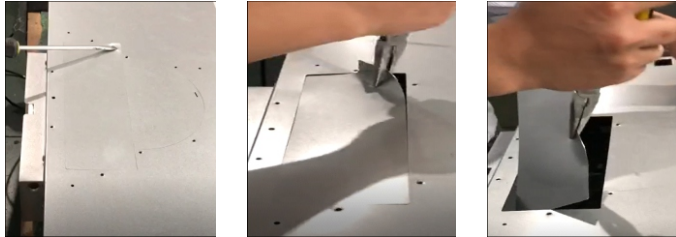

3. Using a flat head screwdriver and pliers, remove the half-round stainless-steel plate.

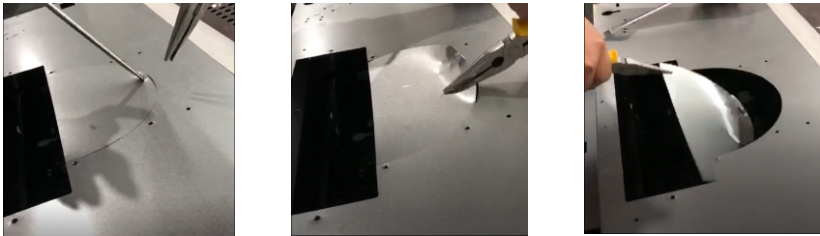

4. Reassemble the air vent (C) to the top of the range hood using the (4) set screws removed in step one.

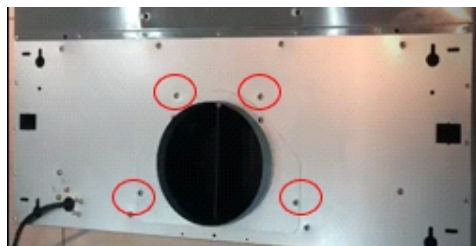

Ventilate out of your dwelling vertically by using the 3-1/4" X 10" air vent (D) that will be assembled on the top of range hood

1. Follow steps 1 and 2 from above. **Do not remove the half-round stainless-steel plate.**

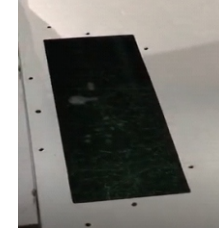

2. Attach the 3-1/4" X 10" air vent (D) using the (6) #8 X 3/8 screws.

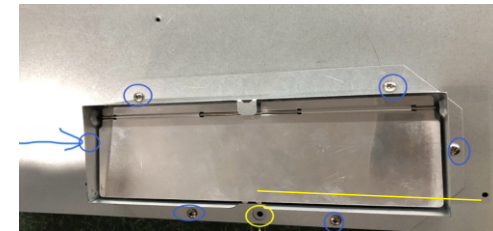

Do not use this hole

Ventilate out of your dwelling horizontally by using the 3-1/4" X 10" air vent (D) that will be assembled to the rear of range hood

1. On the rear of the range hood, remove the two set screws as shown below. Some models may not have set screws.



2. Using a flat head screwdriver and pliers, remove the 3-1/4" X 10" stainless-steel plate.



- Attach the 3-1/4" X 10" air vent (D) using the (6) #8 X 3/8 screws



Recirculate the air (non-ducted) within your dwelling

- Remove the (4) set screws from the air vent (C) that is attached to the top of the range hood.

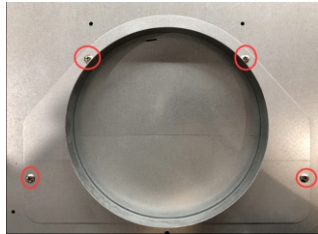

- Discard the air vent (C) and set screw. Note: You may also discard the 3-1/4" X 10" air vent (D).
- Remove the recirculating plate cover (located on top of range hood) by removing the two set screws. Discard the recirculating plate cover.

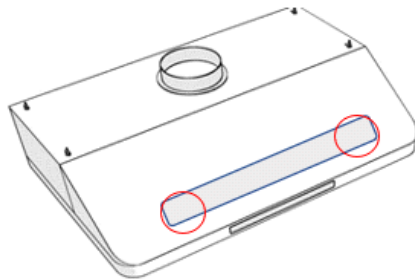

Power cord option for Hard Wired Models

- The power cord is preconfigured with an exit to the top of the unit.
- To have the power cord exit the rear of the unit remove the filters (E).
- Place range hood on work surface with bottom facing up.
- With a flat head screwdriver, insert the screwdriver into the punch-out slot (F) and pull towards you. This will remove the pre-formed power cord hole cover. Discard the punch-out.

- Pull the power cord out of the preassembled location and insert into the rear exit hole (F).
- For some models, you may have to remove the strap holding down the power cord. Simply remove the two nuts and the strap. This will give slack to the power cord to move to the new location. Replace strap and nuts after power cord has been moved to new location. **See Exhibit B.**

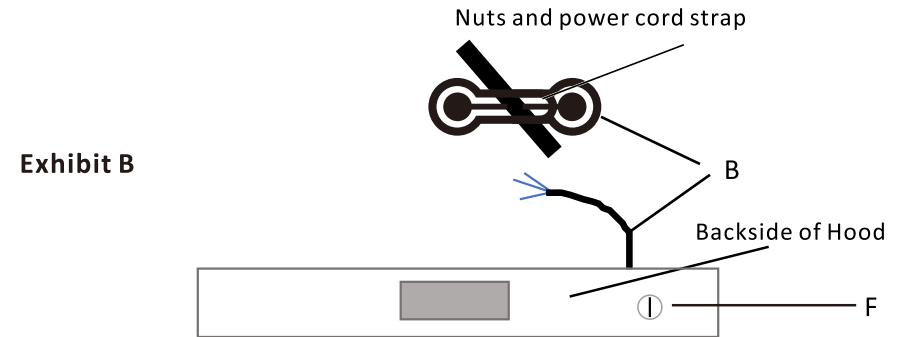

Installing the Range Hood

This installation is for mounting the product to the bottom of the cabinet. Please consult your professional installation specialist regarding the best type of mounting to suit your cabinets construction. Please be sure to read the entire instructions prior to installation.

- Begin installation by removing the baffle or mesh filters from the bottom of the range hood, removing any tape on the air flow flappers, and removing any protective film on the touch sensor control panel (depending on model).
- Determine location of power outlet or hardwire connection. You will need to create a cut-out hole on the bottom of the cabinet for the power cord. Prior to mounting the range hood, the power cord will be fed through the cut-out hole. For hard-wired installations choosing the rear exit for power, this cut-out hole is not required (see *Power cord option for Hard Wired Models*).
- For Ducted Installations Only:**
 - Measure the location where the duct (C or D) will enter the bottom of the cabinet or the wall for rear ducting.
 - Drill/cut out the required openings using a sabre saw or jigsaw for the duct; make sure the duct opening is large enough accommodate ducting and to apply duct tape.
 - The cutout can be larger than the duct (C or D) dimension to allow room for ducting and duct tape.

Prior to creating cut-outs, please verify the accuracy of your dimensions with a tape measurer and consult with a professional installation specialist.

There are two options for installing the range hood to the bottom of your cabinet:

- **Patented One-Person Easy Installation Method for Framed and Frameless Cabinets.**
- **Traditional Method for Framed and Frameless Cabinets.**

Patented One-Person Easy Installation Method-Framed and Frameless Cabinets

For Framed Cabinets:

1. Install the easy installation brackets (H) under the cabinet on each side. The brackets will be labeled Left (L) Right (R) Front (F) Back (B). Insert and screw in the (4) #8 X 5/8" wood screws (H.a) as shown below to each bracket. You may choose to drill a starter hole. **NOTE: Cabinet constructions will differ, ensure the length of the screw is appropriate for the depth of the bottom of your cabinet. Shorter screws may be needed to ensure you do not screw through the base of the cabinet.**

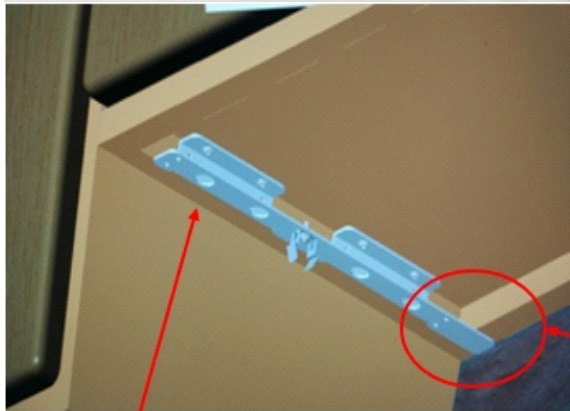
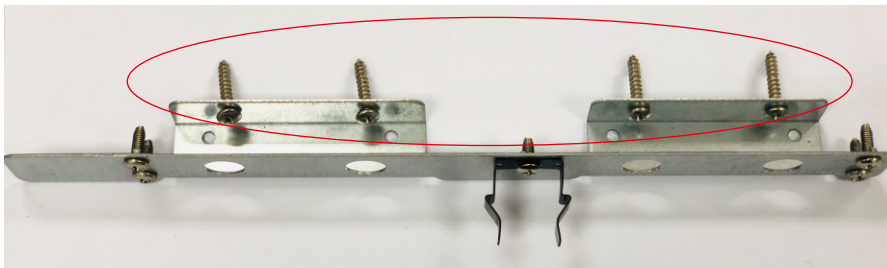

Flush to back

2. Raise and align the top of the range hood to the spring clips as shown below. Snap the range hood into the spring clip. This will suspend the range hood until final installation. Be sure to place the power cord through the bottom of the cabinet.

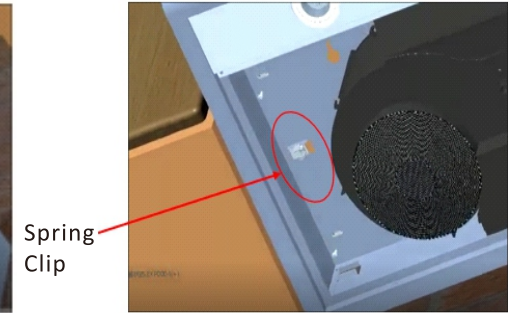
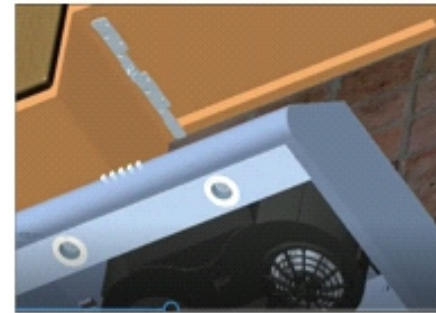

Spring
Clip

3. For final securing of the range hood to the bottom of the cabinet, screw in (4) of the #8 X 3/8" machine screws to each of the easy installation brackets as shown below.

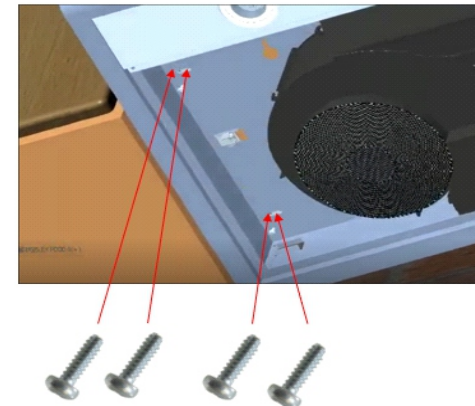

For Frameless Cabinets:

1. Install the two easy installation brackets (G) to each side of the cabinet as shown below using the #8 X 5/8" screws (G.a.) (cabinet constructions will differ, ensure the length of the screw is appropriate for your cabinet construction).

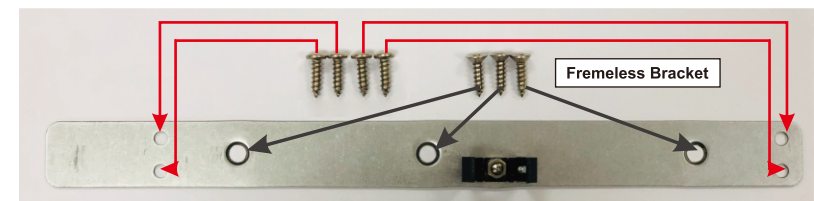

- The easy installation brackets (G) under the cabinet on each side. The brackets will be labeled Left (L) Right (R) Front (F) Back (B). Insert and screw in the (3) #8 X 5/8" screws (G.a.) as shown below. You may choose to drill a starter hole.

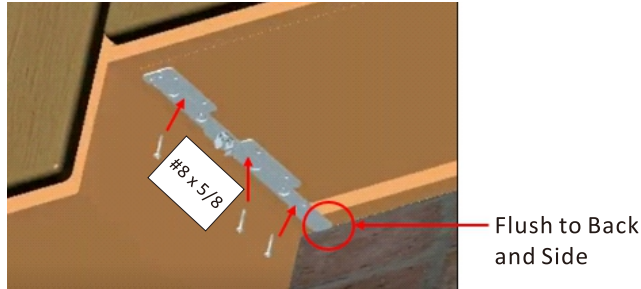

- Same as step 2 for Framed cabinet
- For final securing of the range hood to the bottom of the cabinet, screw in (4) of the #8 X 5/8" wood screws (G.a) to each of the easy installation brackets to bottom of cabinet as shown below.

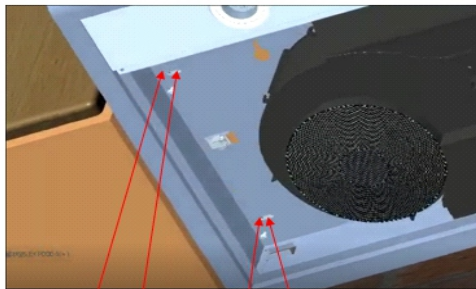

- (Optional) You may wish to additionally secure the range hood by screwing in (2) #8 X 5/8" wood screws (G a.) into the access hole as shown below to the bottom of the cabinet.

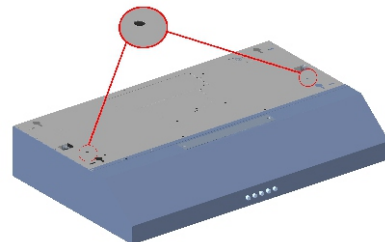
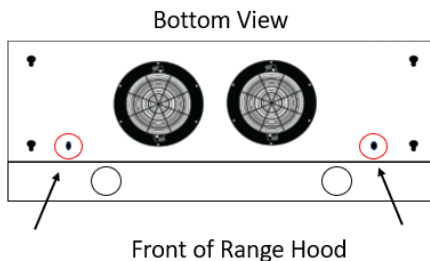

Electrical

- If your unit comes with a three-pronged plug, insert into outlet.
- If your unit is hard-wired, make sure this is done by a qualified electrician in accordance with all national and local electrical codes.
 - Before connecting the wires, switch the power off at the service panel and lock the service panel to prevent power from being switched on accidentally.
 - Connect the Black to Live, White to Neutral, and Green to Ground by either a solder or with electrical connectors.
 - This unit must be properly grounded.

Traditional Method for Framed and Frameless Cabinets

Note: Hardware not provided for this assembly option. Consult with your professional installation specialist for what type of fasteners should be used for your cabinet construction.

- If cabinets have face frames with a recessed bottom, attach 2-3" wide wood filler strips to the underside of the cabinet bottom on each side. Be sure the width of the filler strip does not cover the power cord hole. If you wish to use wider filler strips you will need to cut a hole in the filler strip to accommodate the power cord. Secure filler strips to bottom of cabinet using screws (not supplied). The range hood will attach to the filler strips. **If you are not using filler strips due to your cabinet not having a face frame, you may choose to use shorter screws based on the depth of your cabinet bottom.**

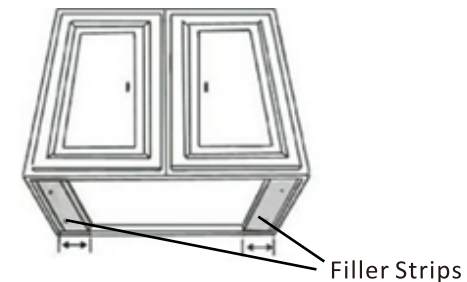

- Determining the fastener locations.
 - Temporarily remove the 3-1/4" X 10" rectangular or 7" round duct vent on top or back of range hood.
 - Temporarily position the range hood in the desired mounting location under the cabinet (this will require 2 people). Mark the mounting holes with a pencil or marker at the center of the 4 mounting keyholes. You will

mark the holes from underneath the range hood to the bottom of the cabinet. **Leave a small gap between the range hood and the wall.**

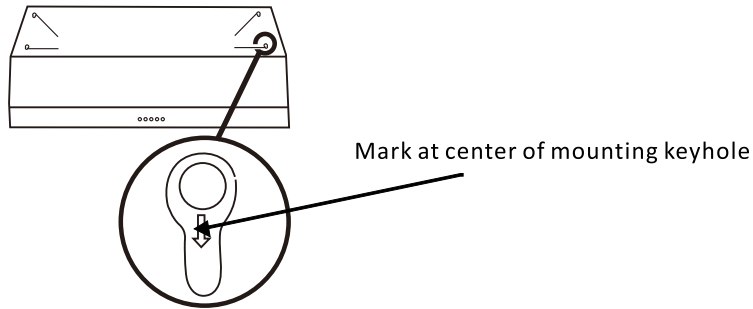

3. After mounting holes have been marked, reassemble the 3-1/4" X 10" rectangular or 7" round duct vent to the range hood.
4. Drill a starter pilot hole (make sure starter hole is not larger than the diameter of the screw) into the bottom of the cabinet for each of the mounting hole marks created in step (2) b.
5. Insert four screws (not supplied) into the holes marked in step (2) b. Do not screw all the way in. Leave a 1/4" or more space.

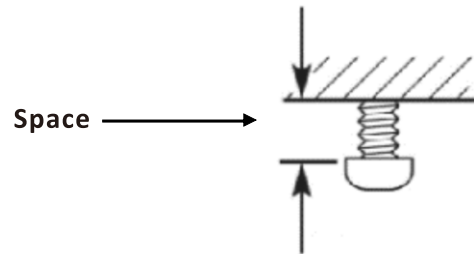

6. Lift range hood (2 people) and position so that the large opening of the mounting keyholes are over the screws. Please ensure you push the electrical cord through the bottom of the cabinet. Push range hood up and gently towards the wall. The range hood should lock into the narrow portion of the keyholes and be secure for final installation. See exhibit D.



7. From underneath range hood finish tightening the screws from step 5. Use a level to ensure the range hood is balanced as you tighten screws.

Ducted/Ductless Operation

1. Some models, depending on motor configuration, have a lever on the bottom of the range hood to determine whether the range hood will operate in the ducted or ductless mode. For other models, simply removing or not removing the recirculating plate cover on top of the range hood will determine ducted or ductless mode of operation. If you model has this lever shown on the image below, you will select either the ducted or ductless mode of operation.
2. On the bottom of the range hood, there will be a lever to determine the airflow. Select **External** if you chose the ducted option. Select **Ductless** if you chose the recirculating option. The mode of operation is preset to external ventilation. For ductless operation, remove the screw as in the picture below, and flip the lever to ductless. Reattach the screw.



Electrical

1. If your unit comes with a three-pronged plug, insert into outlet.
2. If your unit is hard-wired, make sure this is done by a qualified electrician in accordance with all national and local electrical codes.
 - a) Before connecting the wires, switch the power off at the service panel and lock the service panel to prevent power from being switched on accidentally.
 - b) Connect the Black to Live, White to Neutral, and Green to Ground by either a solder or with electrical connectors.
 - c) This unit must be properly grounded.
3. Install duct work and seal with duct tape.
4. Reinstall the filters (E).

OPERATING INSTRUCTIONS

Note: There are different operating instructions based on the control panel for your model. Please choose the operating instruction for your unit.

Powering on/off the unit

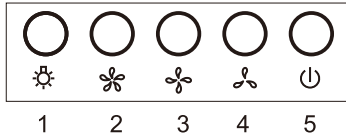

- To turn the fan on push a button to select one of the 3 speeds:
 - 2=High
 - 3=Medium
 - 4=Low
 If you choose a new speed by pressing a different button, the new fan speed will replace the old fan speed.
- To turn fan off push button 5.
- To operate light on/off push button 1 (Note: The fan and light operate independently of each other).

Powering on/off and Settings:



- **Lamp:** Press the lamp display one time to activate the light, press the lamp display again to deactivate it.
- **Power/Standby:** When the range hood is in the “original” state, touch this button. It will enter the standby mode.
- **Setting the clock:** When the range hood is on “Standby” Mode, press and hold the timer button for 3 seconds. The range hood will then enter the time setting state; the display screen will show numbers. Press the Plus to set hours and Press the Minus to set the minutes. After 10 seconds, it will automatically exit the time setting state and the time you have entered will be saved.
- **Timer:**
 - When the fans are operating, touch the timer button one time. This will turn on the timer mode and the display with show 03:00. Each time you

press the timer button, it will increase by 1 minute with the maximum timer setting of 60 minutes. Within the last 3 seconds of the timer setting, the range hood will make three beeps.

- When range hood is on, touch the Power/Standby once and the shut off timer will set to 60 seconds. Touch the button twice and the fan will turn off.
- **Fan Operation :**
 - In standby mode, press the Minus button one time and the range hood will start at F1 speed. If the button is pressed again, the speed will stay the same.
 - In standby mode, press the Plus button one time, the range hood will start at F3 speed. If the button is pressed again, the speed will stay the same.
 - To lower or increase the fan speed press the Plus or Minus buttons.
 - When fan is in the standby mode, press the Fan button to reach maximum speed immediately. Touching this button while in a lower speed will automatically take to the maximum speed. Touching the Fan button twice will turn the fan off.

Powering on/off and Settings:

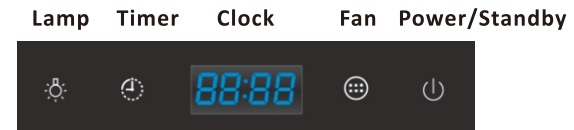

- **Lamp:** Press the lamp display one time to activate the light, press the lamp display again to deactivate it.
- **Power/Standby:** When the range hood is in the “original” state, touch this button. It will enter the standby mode.
- **Setting the clock:** When the range hood is on “Standby” Mode, press and hold the timer button for 3 seconds. The range hood will then enter the time setting state; the display screen will show numbers. Press the Fan button to set hours and press the Lamp button to set the minutes. After 10 seconds, it will automatically exit the time setting state and the time you have entered will be saved, or press the Timer button to exit and keep saved time.
- **Fan Operation:**
 - In standby mode, press the Fan button one time and the range hood will start at F3 speed. If the Fan button is pressed again, the speed will reduce to F2. If the Fan button is pressed again, the speed will reduce to F1. Pressing the Fan button after the F1 setting will shut off the fan.
- **Timer:**
 - When the fans are operating, touch the Timer button one time. This will turn on the timer mode and the display with show a flashing 03:00, after

8 seconds the display will stop flashing and begin counting down. Each time you press the timer button, it will increase by 1 minute with the maximum timer setting of 60 minutes. Within the last 3 seconds of the timer setting, the range hood will make three beeps.

- o When range hood is on, touch the Power/Standby once and the shut off timer will set to 60 seconds. Touch the button twice and the fan will turn off.

Powering on/off and Settings:

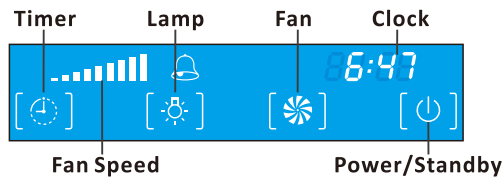

- **Lamp:** Press the lamp display one time to activate the light, press the lamp display again to deactivate it.
- **Power/Standby:** When the range hood is in the “original” state, touch this button. It will enter the standby mode.
- **Setting the clock:** When the range hood is on “Standby” Mode, press and hold the timer button for 3 seconds. The range hood will then enter the time setting state; the display screen will show numbers. Press the Fan button to set hours and press the Lamp button to set the minutes. After 10 seconds, it will automatically exit the time setting state and the time you have entered will be saved, or press the Timer button to exit and keep saved time.
- **Fan Operation:**
 - o In standby mode, press the Fan button one time and the range hood will start at high speed (all nine bars will be illuminated on the fan speed bar). If the Fan button is pressed again, the speed will reduce to medium (six bars will be illuminated). If the Fan button is pressed again, the speed will reduce to low (three bars will be illuminated). Pressing the Fan button after the low speed setting will shut off the fan.
- **Timer:**
 - o When the fans are operating, touch the Timer button one time. This will turn on the timer mode and the display will show a flashing 01:00, after 8 seconds the display will stop flashing and begin counting down. Each time you press the timer button, it will increase by 1 minute with the maximum timer setting of 60 minutes. Within the last 3 seconds of the timer setting, the range hood will make three beeps.
 - o When range hood is on, touch the Power/Standby once and the shut off timer will set to 60 seconds. Touch the button twice and the fan will turn off.

Powering on/off and Settings:



- **Lamp:** Press the lamp display one time to activate the light, press the lamp display again to deactivate it.
- **Power/Standby:** When the range hood is in the “original” state, touch this button. It will enter the standby mode.
- **Setting the clock:** When the range hood is on “Standby” Mode, press and hold the timer button for 3 seconds. The range hood will then enter the time setting state; the display screen will show numbers. Press the Plus to set hours and Press the Minus to set the minutes. After 10 seconds, it will automatically exit the time setting state and the time you have entered will be saved.
- **Timer:**
 - o When the fans are operating, touch the timer button one time. This will turn on the timer mode and the display will show 03:00. Each time you press the timer button, it will increase by 1 minute with the maximum timer setting of 60 minutes. Within the last 3 seconds of the timer setting, the range hood will make three beeps.
 - o When range hood is on, touch the Power/Standby once and the shut off timer will set to 60 seconds. Touch the button twice and the fan will turn off.
- **Fan Operation:**
 - o In standby mode, press the Minus button one time and the range hood will start at F1 speed. If the button is pressed again, the speed will stay the same.
 - o In standby mode, press the Plus button one time, the range hood will start at F3 speed. If the button is pressed again, the speed will stay the same.
 - o To lower or increase the fan speed press the Plus or Minus buttons.
 - o When fan is in the standby mode, press the Fan button to reach maximum speed immediately. Touching this button while in a lower speed will automatically take to the maximum speed. Touching the Fan button twice will turn the fan off.

Powering on/off and Settings:



- To turn the fan on, push the button to the HI or LO setting. Returning the button to the middle position will turn the fan off.

- To turn the light on, push the button to the ON position. To turn the light off, push the button to the OFF position.

Powering on/off and Settings:



- **Lamp:** Press the light display buttons to activate the light. Low, Medium, and High settings. To turn off, touch the light display button.
- **Fan Controls:** Press the fan display buttons to activate the fan. Low, Medium, and High settings. To turn off, touch the fan display button.

CARE and MAINTENANCE

Cleaning

IMPORTANT: Clean the hood and panel filters frequently per the following instructions. Replace the panel filters before operating hood.

Exterior Surfaces

To avoid damage to the exterior surface, do not use steel wool or soap filled scouring pads. Always wipe dry to avoid water marks.

Cleaning Method

Use liquid mild-detergent soap and water, do not use hard abrasive cleaners. Wipe with damp soft cloth or non-abrasive sponge, then rinse with clean water and wipe dry.

Do's:

- Clean your range hood using a non-abrasive cloth or sponge and liquid detergent.
- Always wipe in the direction of the grain pattern.
- After cleaning rinse with water.
- Make sure range hood is dry after cleaning.

Don'ts:

- Do not use steel wool or like products as this will cause scratching and iron residue that could lead to rusting and corrosion.
- Do not wipe against the grain pattern as this will impact the original finish.
- Do not use chlorine bleach.

Grease/Baffle Filter

- Remove the filter by pulling the spring release handle and then pulling down the filter.
- Wash filters as needed in dishwasher or hot detergent solution (low temperature, short cycle).
- If your model has a grease tray, please remove, drain and clean periodically.
- Make sure filters are completely dry before putting back into range hood.
- Reinstall the filter by making sure the spring release handles are toward the front. Insert filter into upper track.
- Push the spring release handle.
- Push up on filter and release handle to latch into place.

Replacing the LED light

- Turn off the range hood and allow the light to cool..
- To avoid damage or decreasing the life of the new bulb, do not touch bulb with bare fingers. Replace bulb wearing cotton gloves to handle bulb.
- If new light does not operate, make sure the lamps are inserted correctly before calling for support.

To replace:

1. Disconnect the power cord to ensure unit does not turn on.
2. Remove filters.
3. Reach behind the light and push towards you until the light pops out.
4. Disconnect the electrical harness.
5. Attach new bulbs to the electrical harness.
6. Snap bulbs back into unit and replace filters.
7. Reconnect the power cord.

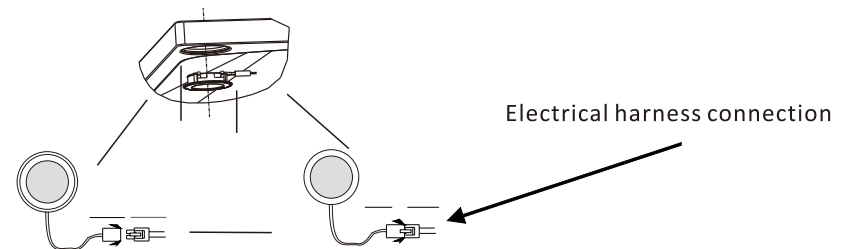

Filters

- To replace the charcoal filter (non-ducted operation), remove the aluminum or baffle filters.
- Turn the filter (attached to fan) counter clockwise to remove filter and clockwise to install new filter.
- Filter model number for these units: WRHF004S2 and HDRHF04S2.

LIMITED WARRANTY

This warranty extends to the original purchaser only. This warranty is not transferable, between homes or owners and is only applicable to residential use. Winslyn Industries, LLC provides a 3-year limited parts warranty for all range hoods. Under this warranty, you (the customer), is entitled to replacement parts at no cost to repair and restore functionality if any part of the product were to fail. No labor is provided. Certain consumables that are not covered under this warranty include Lights (halogen and LEDs), Carbon Filters, Mesh or Baffle Filters, Ducting. These parts are guaranteed to last one year beginning from the date of purchase. If they fail prematurely or are defective within 1 year of purchase, we will replace them at no charge. If a main unit or complete replacement needs to be sent, Winslyn Industries, LLC will require that the customer pay for shipping. Shipping for parts are free under the warranty period. We will provide replacement parts at no charge under normal use and service. We provide you with complete instructions on how to maintain and care for this product. We will not be responsible for due to lack of maintenance or proper use. The original sales receipt, order number, and/or proof of purchase must be presented at the time of the warranty claim, without exception.

As noted in the instructions we recommend the use of a professional installer. Winslyn Industries, LLC will not be held responsible for any damage or product failure due to improper installation, misuse, or failure to use a licensed professional. This warranty only extends for household product use, this warranty will be void for commercial use of this product. This warranty will not be applicable if product is purchased from an unauthorized seller. By purchasing this product, buyer agrees that we are not liable for incidental, consequential, or special damages associated with the return, replacement, installation or use of your product. This includes freight costs, labor, travel time, lost profit, home damages and other contingent liabilities and costs (including, without limitation, costs associated with experts, investigations, analyses, attorneys and other professionals and services). Our warranty is a comprehensive and explicit limit of liability, and all items outside of it are not addressable by or the responsibility of Winslyn Industries, LLC. Certain states have variances regarding implied warranties and in those situations, we remain fully compliant. We make no implication that products comply with any or all local building or plumbing codes. It is the consumer's responsibility to determine local building code. Please write or contact us at:

Winslyn Industries, LLC
1232 Hardt Circle
Bartlett, Illinois 60103
Email: support@winslyn.com

Winpro® Sinks Winflo® Range Hoods
Winette® Bathroom Vanities