

GTDU

Installation Instructions

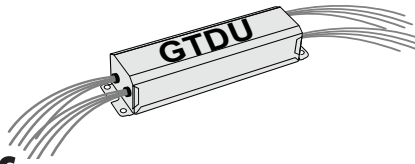

UL 1008-BCELTS



UL 924-Switch Bypass

! IMPORTANT SAFEGUARDS !

WHEN USING ELECTRICAL EQUIPMENT, BASIC SAFETY PRECAUTIONS SHOULD ALWAYS BE FOLLOWED, INCLUDING THE FOLLOWING:

READ AND FOLLOW ALL SAFETY INSTRUCTIONS

1. This product is for use with generator or central inverter supplied fluorescent, incandescent or LED fixtures. Make sure all connections are in accordance with the National Electrical Code or Canadian Electrical Code and any local regulations.
2. To reduce the risk of electric shock, disconnect all power sources before servicing.
3. This product is for factory or field installation.
4. This product is suitable for damp locations where the ambient temperature is -20°C minimum, +65°C maximum. The product is also suitable for installation in sealed and gasketed fixtures. Product is not suitable for heated air outlets and wet or hazardous locations.
5. This product is UL Listed as either a Branch Circuit Emergency Lighting Transfer Switch (BCELTS) under UL 1008 or a Switch Bypass under UL 924. Use the proper wiring diagram in the appropriate section of these instructions.
6. An unswitched, normal AC power source and a direct, unswitched connection to a generator or central inverter supplied emergency panel is required (120 through 277 VAC, 50/60 Hz).
7. Do not install near gas or electric heaters.
8. The use of accessory equipment not recommended by the manufacturer may cause an unsafe condition.
9. Do not use this product for other than intended use.
10. Servicing should be performed by qualified service personnel.
11. Equipment should be mounted in locations and at heights where it will not readily be subjected to tampering by unauthorized personnel.
12. This device complies with Part 15 of the FCC Rules. Operation is subject to the following two conditions: (1) this device may not cause harmful interference, and (2) this device must accept any interference that may cause undesired operation.
13. This product must be grounded. See wiring diagrams for details.
14. This product has a Short Circuit Current Rating (SCCR) of 5kA when protected by fuses. See Table 1 for details.

SAVE THESE INSTRUCTIONS



CAUTION: THIS UNIT HAS MORE THAN ONE POWER SUPPLY CONNECTION POINT. TO REDUCE THE RISK OF ELECTRIC SHOCK, DISCONNECT ALL POWER SOURCES BEFORE INSTALLING OR SERVICING THIS UNIT.

SERVICE BY QUALIFIED PERSONNEL ONLY

NOTE: BEFORE INSTALLING THIS DEVICE, MAKE SURE THE NECESSARY BRANCH CIRCUIT WIRING IS AVAILABLE. AN UNSWITCHED SOURCE OF NORMAL POWER IS REQUIRED. A SEPARATE CONNECTION TO A GENERATOR-SUPPLIED (OR CENTRAL INVERTER SYSTEM-SUPPLIED) CIRCUIT MUST ALSO BE PROVIDED.

11/01/19

Bodine © 2019 Signify Holding. All rights reserved.

236 Mt. Pleasant Rd. • Collierville, TN USA 38017-2752 • Tech Support 888-263-4638 • Fax 901-853-5009 • www.bodine.com
443529080234

INSTALLATION

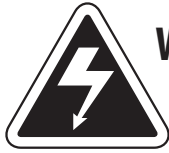

WARNING: Disconnect all power sources before installing or servicing this unit.
The GTDU is intended for an electrical load of ONE fixture only.

NOTE: BEFORE INSTALLING THIS DEVICE, MAKE SURE THE NECESSARY BRANCH CIRCUIT WIRING IS AVAILABLE. AN UNSWITCHED SOURCE OF POWER ON THE SAME BRANCH CIRCUIT AS THE LED DRIVER OR AC BALLAST IS REQUIRED. A SEPARATE CONNECTION TO A GENERATOR OR CENTRAL INVERTER SUPPLIED CIRCUIT MUST ALSO BE PROVIDED.

INSTALLING THE GTDU

- > FAMILIARIZE YOURSELF WITH THESE INSTRUCTIONS BEFORE BEGINNING INSTALLATION.
- > Disconnect all AC power sources from the fixture. Remove the driver/ballast channel cover and install the GTDU in the driver/ballast channel (see Illustrations 1, 2 and 3).
- > The GTDU metal case must be grounded. One way is to electrically bond it to the luminaire metal surface by exposing bare metal on both and installing the mounting hardware to establish a proper metal-to-metal connection. The GTDU will then be electrically bonded to the AC supply ground through the luminaire.
- > Wire the GTDU as shown in the Wiring Diagrams section of these instructions.
- > After installation is complete, apply AC power to the fixture. Check AC driver/ballast operation to verify proper GTDU installation.

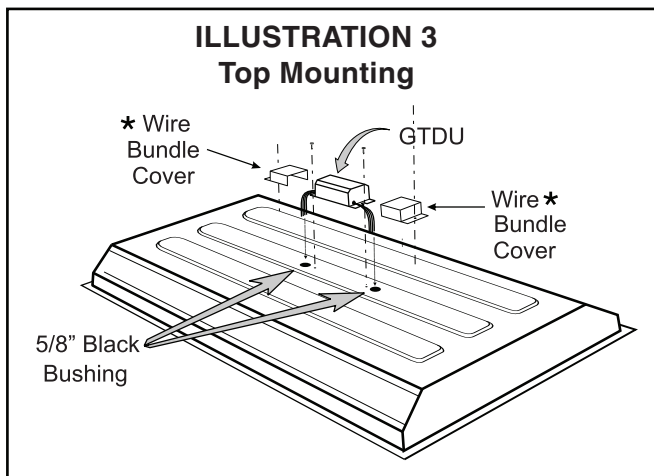
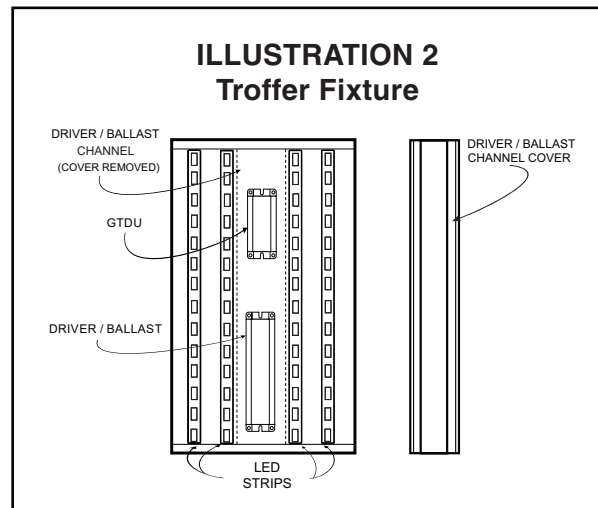
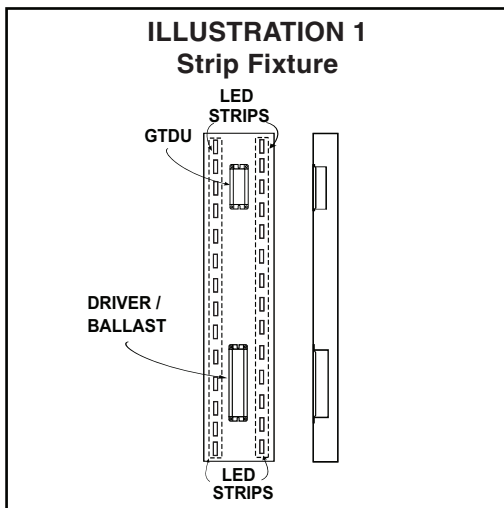

* For installation on top of the fixture, wire bundle covers (RMC-60) may be required by state or local codes. These covers are available from the manufacturer as an accessory kit and must be ordered separately. Call your local distributor or the factory for complete information.

Table 1 - Fuse Specs for 5kA SCCR

MANUFACTURER	MFR PART NO.
Bussmann	LP-CC-3
Bussmann	LP-CC-2-1/2
Bussmann	KTK-R-3
Bussmann	KTK-R-2-1/2
Littelfuse	KLKR-3
Littelfuse	KLKR-2-1/2

OPERATION

The GTDU uses internal relay contacts to control the AC power feeding the driver/ballast. When normal AC power is lost, the GTDU automatically switches the driver/ballast to the emergency power supply, bypassing the local wall switch and, if provided, opens the 0-10VDC dimming signal bringing on the luminaire to full light output. The GTDU can also accept a 24VDC signal from the fire alarm system to transfer it to emergency mode even if normal AC power is still present.

MAINTENANCE

No routine maintenance is required to keep the GTDU functional. However, it should be checked periodically to ensure it is working properly. The entire generator (or central inverter) system, including all designated emergency lighting loads, should be exercised every 30 days per Code to ensure proper operation. To do this: 1) power up the generator, 2) place the main automatic transfer switch in the generator position, 3) turn off the local, unswitched normal power circuit breaker, and 4) verify the designated emergency lighting loads are operating properly from the generator/central inverter supply. **Circuit Breaker (Test Switch) must be located local to the load being controlled.**

WIRING DIAGRAMS for UL 1008 - BCELTS APPLICATIONS

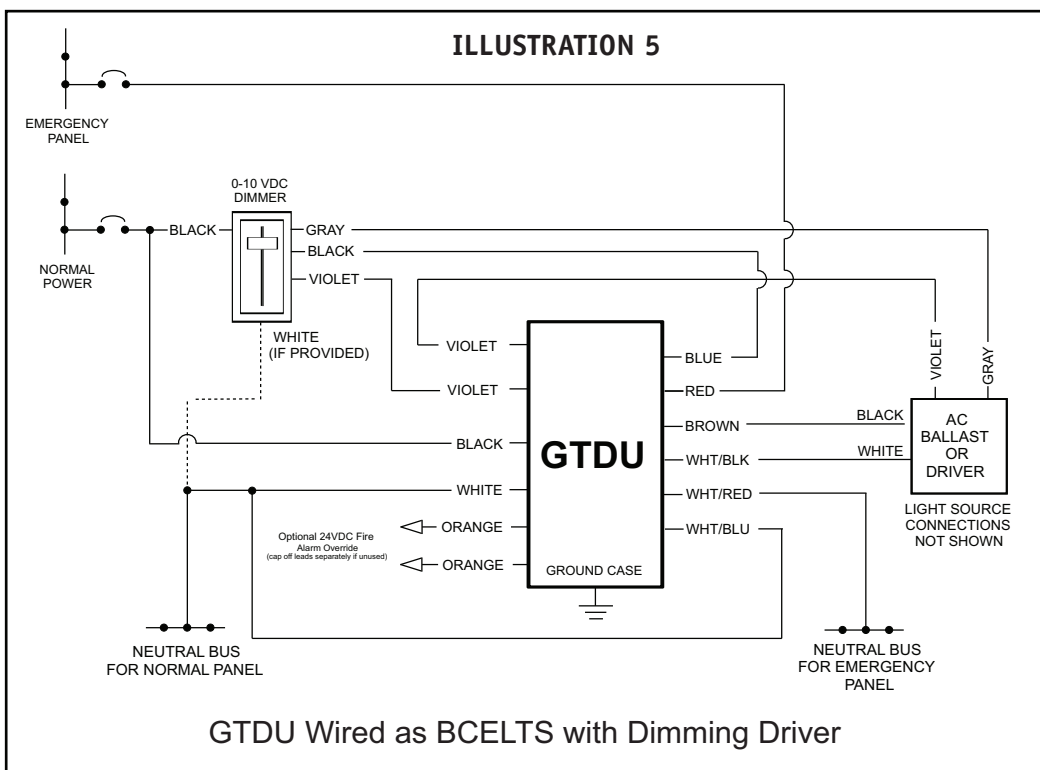
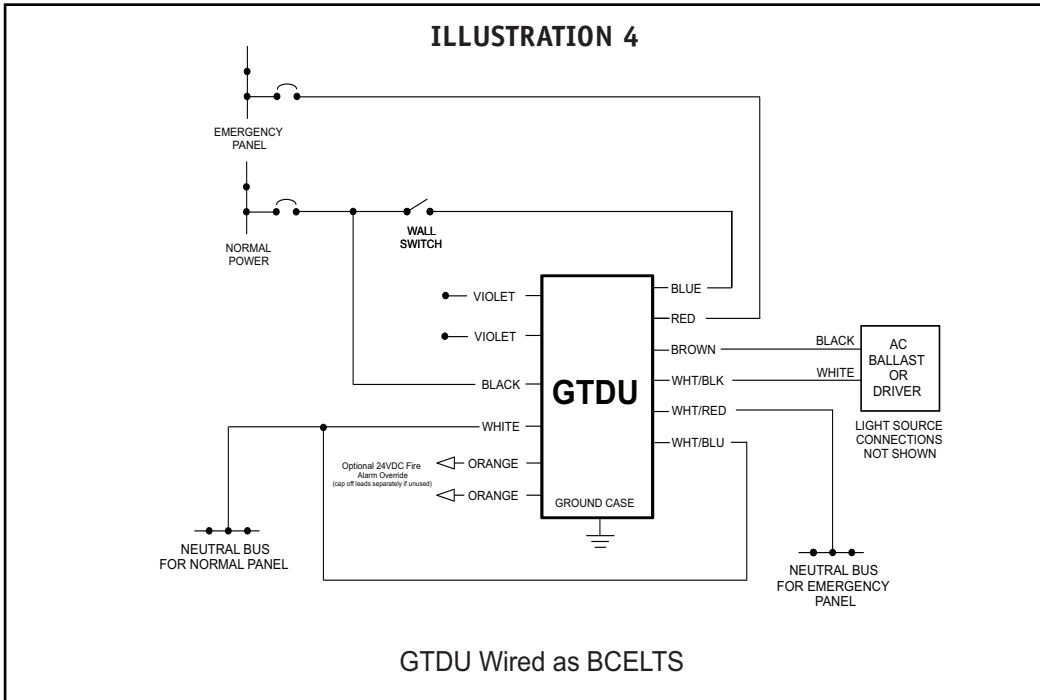

WIRING DIAGRAMS for UL 924 - SWITCH BYPASS APPLICATIONS

