

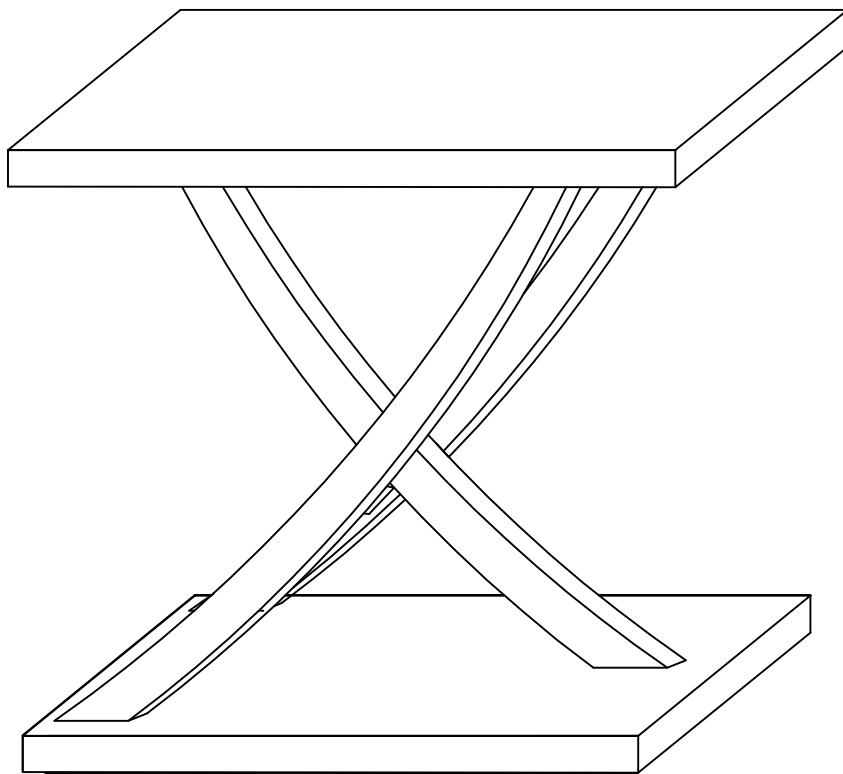

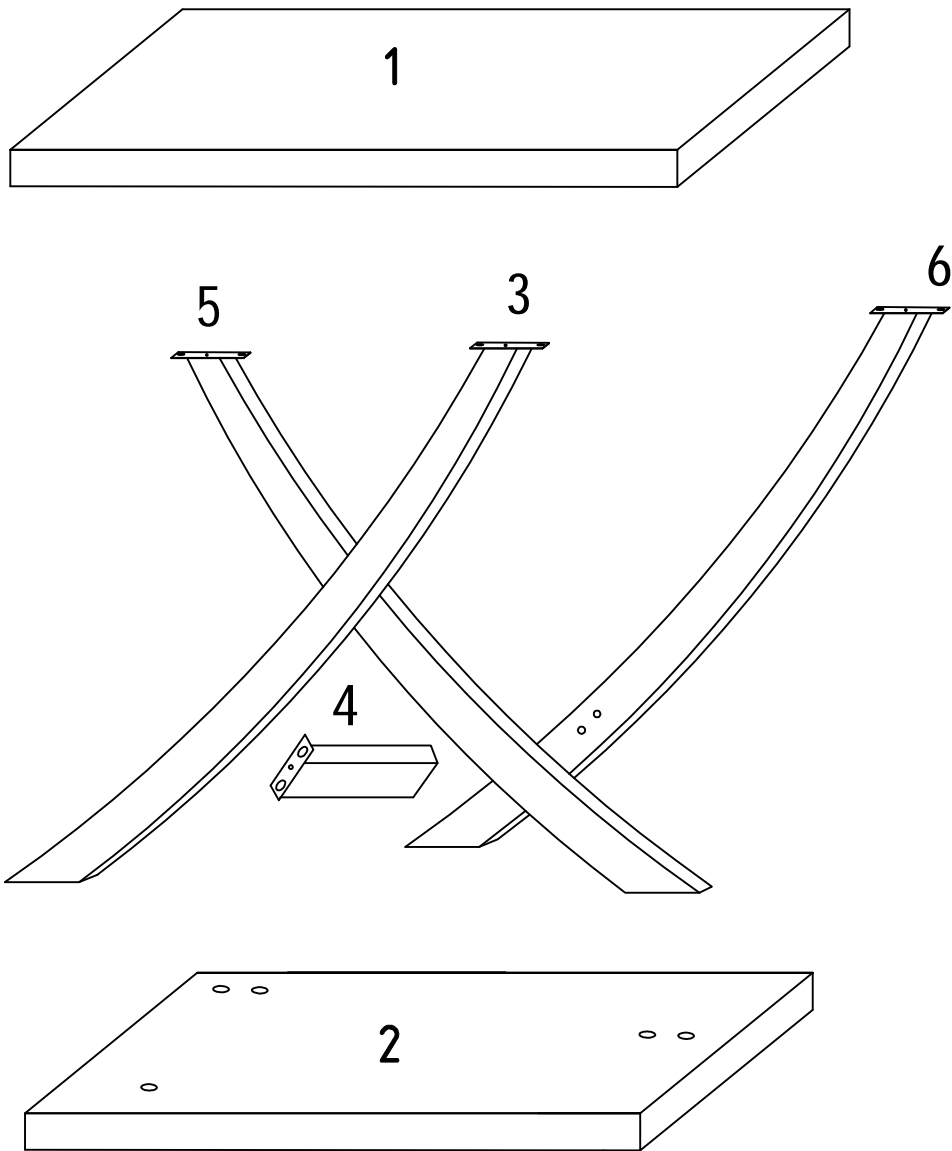







Tribesigns





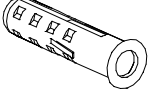

Notes: Don't tighten screws completely at first, just in case parts were assembled wrong and need disassemble. Tighten screws at last when all parts are put together.

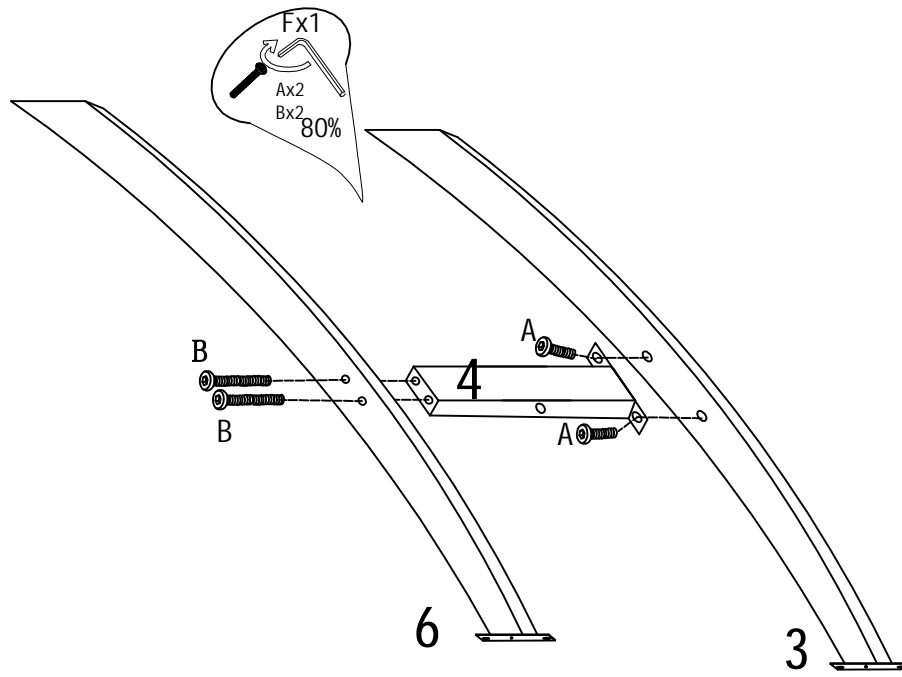

A M6*15mm  8 PCS	B M6*45mm  2 PCS	C M6*60mm  7 PCS	D  6 PCS	E  4PCS
F  1 PC	G  2 PCS	H  2 PCS	I  2 PCS	J  4 PCS



1 Notes: Don't tighten screws completely at first.



A	M6*15mm		2 PCS
B	M6*45mm		2 PCS
F			1 PC

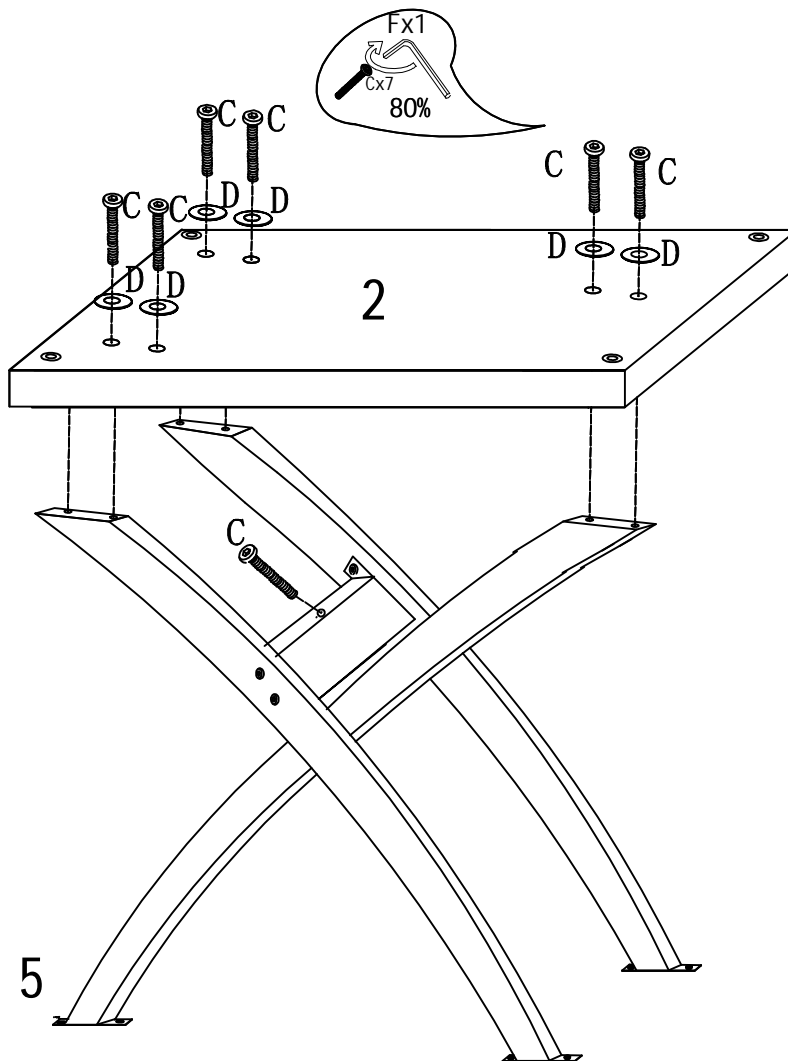



2

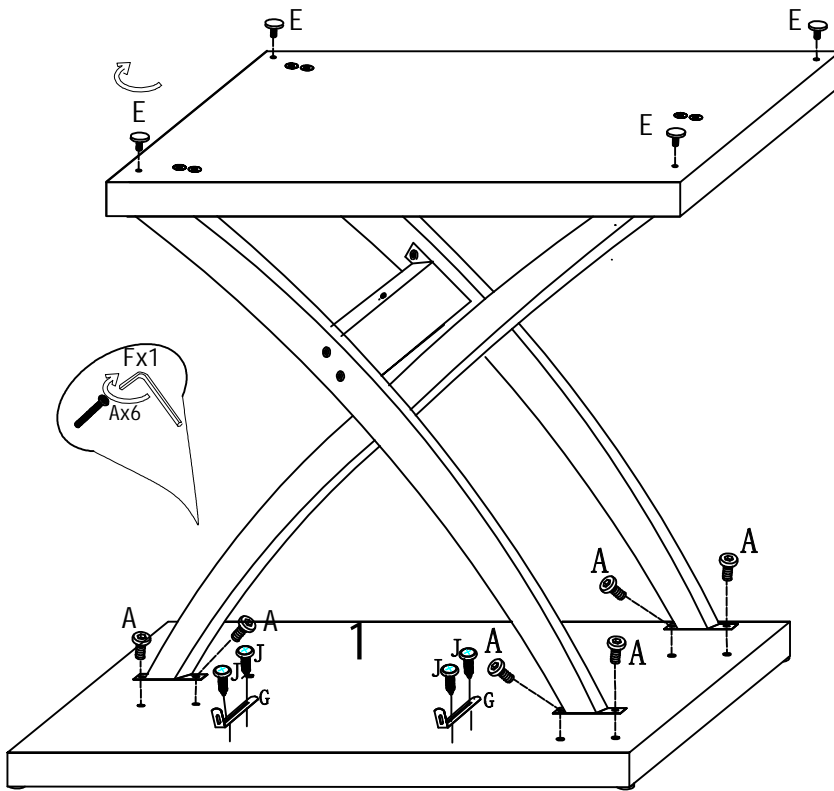

C			7 PCS
D			6 PCS
F			1 PC

5





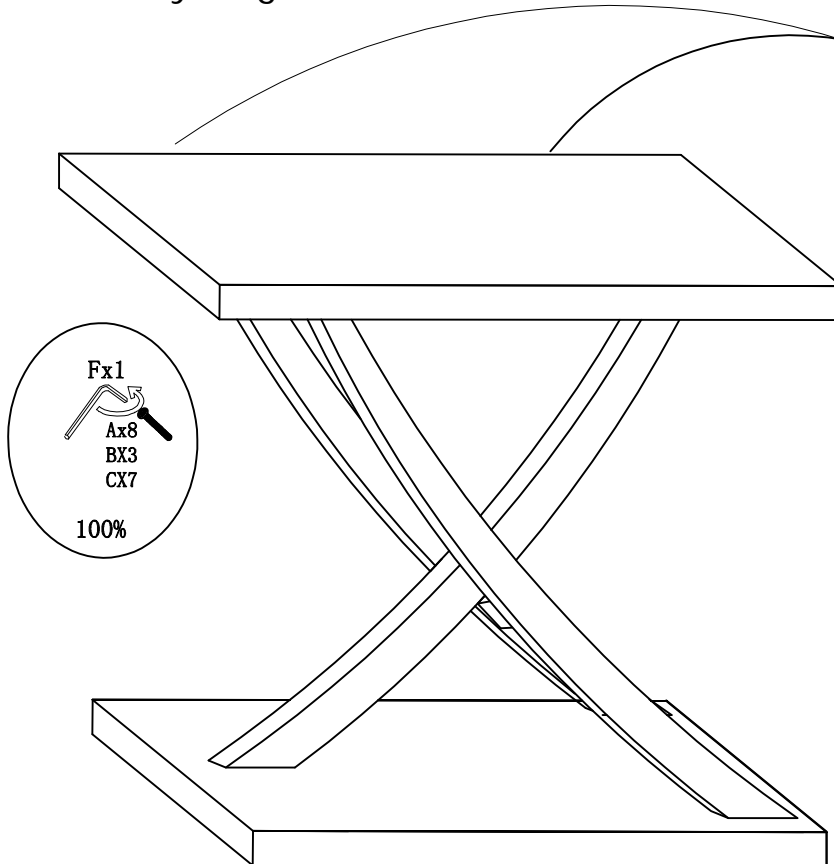

A	M6*15mm
	 6 PCS
E	 4PCS
F	 1 PC
G	 2 PCS
J	 4 PCS

If the holes are not aligned, loosen the screws above, adjust the position of the steel pipe to align the holes, and finally tighten all the screws.

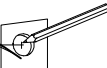
6

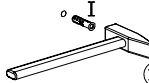
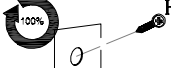

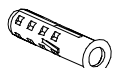
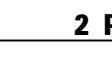
 I
 II
 III
 H
 2 PCS
 I
 2 PCS

Thanks for choosing Tribesigns product, your satisfaction is our priority. If you have any installation problems or any damages caused by shipping, feel free to contact us at "support@tribesigns.com", our friendly customer service will solve problem for you.