

VEVOR[®]

TOUGH TOOLS, HALF PRICE

Technical Support and E-Warranty Certificate www.vevor.com/support

**ICE-MAKING MACHINE
INSTALLATION MAINTENANCE
INSTRUCTIONS
MODEL:LB360TA/LB400TA/LB440TA/LB550TA**

We continue to be committed to provide you tools with competitive price.

"Save Half", "Half Price" or any other similar expressions used by us only represents an estimate of savings you might benefit from buying certain tools with us compared to the major top brands and does not necessarily mean to cover all categories of tools offered by us. You are kindly reminded to verify carefully when you are placing an order with us if you are actually saving half in comparison with the top major brands.

MODEL:LB360TA/LB400TA/LB440TA/LB550TA



NEED HELP? CONTACT US!

Have product questions? Need technical support? Please feel free to contact us:

Technical Support and E-Warranty Certificate
www.vevor.com/support

This is the original instruction, please read all manual instructions carefully before operating. VEVOR reserves a clear interpretation of our user manual. The appearance of the product shall be subject to the product you received. Please forgive us that we won't inform you again if there are any technology or software updates on our product.

SAFETY PRECAUTION



Before the appliance is used, please read the manual carefully. To reduce the risk of fire, electrical shock or injury when using the appliance, follow basic precaution, including the following:

DANGER:

- ◆ Read all instructions before using the ice-making machine.
- ◆ Plug into a grounded 3-prong outlet, do not remove grounding prong, do not use an adapter, and do not use an extension cord.
- ◆ It is recommended that a separate circuit, serving only your appliance be provided. Use an outlet that cannot be turned off by a switch.
- ◆ Never clean appliance parts with flammable fluids. These fumes can create a fire hazard or explosion. And do not store or use gasoline or other flammable vapours and liquids in the vicinity of this or any other appliance. The fumes can create a fire hazard or explosion.
- ◆ Before proceeding with cleaning and maintenance operations, make sure the power line of the unit is disconnected.
- ◆ Do not connect or disconnect the electric plug when your hands are wet.
- ◆ Unplug the appliance or disconnect power before cleaning or servicing. Failure to do so can result in electrical shock or death.
- ◆ Do not attempt to repair or replace any part of your appliance unless it is specifically recommended in this material. All other servicing should be referred to a qualified technician.
- ◆ To prevent a child from being entrapped, Keep out of reach of children and

not in the vicinity of ice-making machine.

- ◆ Before you throw away your old ice-making machine, take off the door but leave the shelves in place so that children may not easily climb inside.
- ◆ Never allow children to operate, play with, or crawl inside the appliance.

 **Warning:**

- ◆ This machine should be operated by professionals or trained personnel; Make sure the machine is reliably connected to the ground to keep safe
- ◆ Use the power consistent with the one in the nameplate, and the bias voltage is less than $\pm 10\%$ of the rated voltage. The professionals must do the wiring;
- ◆ If the supply cord is damaged, it must be replaced by the manufacturer, its service agent or similarly qualified persons in order to avoid a hazard.;
- ◆ Before maintaining the machine, make sure you have cut off the power;
- ◆ Don't wet or sprinkle the liquid onto the plugs, motors, or other electrical parts to avoid electric shock;
- ◆ This appliance can be used by children aged from 8 years and above and persons with reduced physical, sensory or mental capabilities or lack of experience and knowledge if they have been given supervision or instruction concerning use of the appliance in a safe way and understand the hazards involved. Children shall not play with the appliance. Cleaning and user maintenance shall not be made by children without supervision.

 **FLAMMABLE REFRIGERANT**

For your safety observe the following recommendations.

- ◆ This appliance contains a small quantity of R290/R600a ice-making machine which is environmentally friendly, but flammable. It does not damage the ozone layer, nor does it increase the greenhouse effect.
- ◆ During transportation and installation, ensure that the tubing of the refrigerant circuit is not damaged.
- ◆ when handling, moving and use of the refrigerator or freezer to avoid either damaging the refrigerant tubing or increasing the risk of a leak.
- ◆ Avoid using or manipulating sharp objects near by the appliances.
- ◆ Leaking refrigerant can ignite and may damage the eyes.
- ◆ In the event any damage does occur, avoid exposure to open fires and any device which creates a spark. Disconnect the appliance from the mains power.
- ◆ Thoroughly ventilate the room in which the appliance is located for several minutes.
- ◆ Notify Customer Service for necessary action and advice.
- ◆ The ice-making machine quantity contained in this appliance is listed above in grams; it is also noted on the Rating Plate of the appliance.



◆ **WARNING: During using, service and disposal the appliance, please pay attention to symbol similar as left side, which is located on rear of appliance (rear panel or compressor) and with yellow or orange color. It's risk of fire warning symbol. There are flammable materials in refrigerant pipes and**

compressor. Please be far away fire source during using, service and disposal.



Note:

- ◆ Please keep the water or other conductive liquids away from the machine;
- ◆ Don't stick clubs into the machine;
- ◆ During the movement of the machine, it should be carefully carried at an angle of less than 45 degrees.

Prohibit water discharge pipe or water supply pipe from being bent so that the pipes are damaged and water leaks out from the pipes.

- ◆ The distance between the air outlets and the wall should be over 20 cm. Besides, keep good ventilation and ensure the machine is dry and clean.
- ◆ **FCC STATEMENT:** This device complies with Part 15 of the FCC Rules. Operation is subject to the following two conditions:(1)This device may not cause harmful interference, and (2)this device must accept any interference received, including interference that may cause undesired operation.

SAVE THESE INSTRUCTIONS

BASIC PARAMETER

Model	LB360TA	LB400TA	LB440TA	LB550TA
Power	700W	800W	1000W	1000W
Max ice production capacity	≥360	≥400	≥440	≥500
Number of ice cells	12*13=156 PCS	12*13=156 PCS	13*14=182 PCS	13*14=182 PCS
Input	AC115V 60Hz			
Ice size	22*22*22mm			
Ice storage capacity	Theoretical ice storage: 150Kg; Automatic ice filling: 100Kg			
Operator schema	Touch Screen			
Screen size	3.5-inch resistive display			
Climate type	SN、N、ST			



	A	B	C	D	E	F	G
LB360TA	560	585	910	100	1570	615	837
LB400TA	560	585	910	100	1570	615	837
LB440TA	560	585	910	100	1570	615	837
LB550TA	560	585	910	100	1570	615	837

BASIC STRUCTURE

Split type

No.	Name	No.	Name
1	Top panel	8	Ventilation window
2	Water pump	9	Water supply valve
3	Water level sensor	10	Condenser
4	Front panel	11	Fan motor
5	Control panel	12	Compressor
6	Evaporator	13	Deicing solenoid valve
7	Right panel	14	Water storage tank

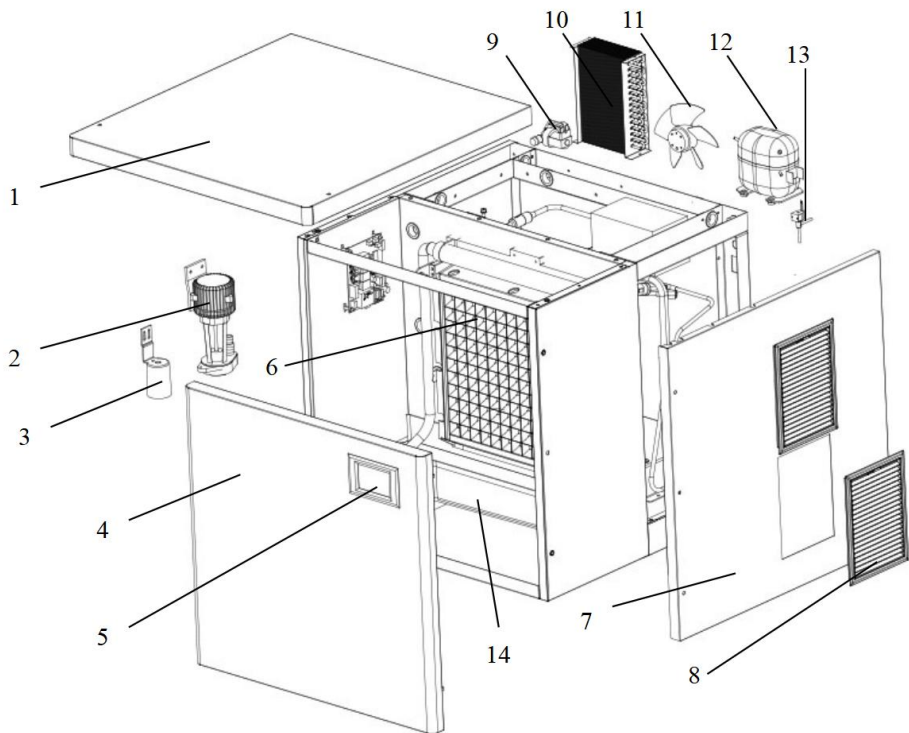

INSTALLATION

Open the case, move the machine to a appropriate location. Check the packing list and the contents, if they are different, please inquire your dealer.

2. Operating environment

A. Environment temperature: SN、N: 10°C~38°C

Environment humidity: relative humidity ≤90%

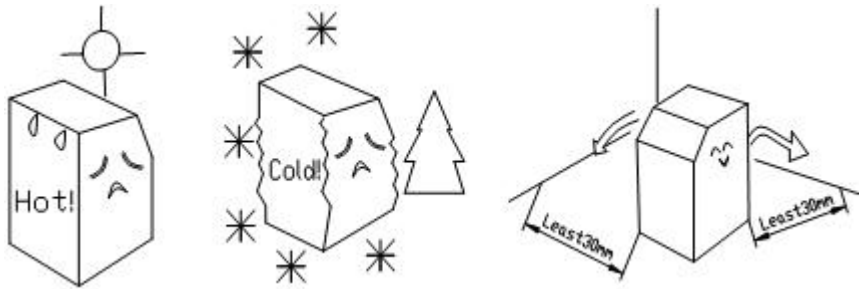

The distance between the air outlets and the wall should be over 20 cm. Besides, keep good ventilation and ensure the machine is dry and clean. The position to place the ice maker must be far away from the heat source, such as a bake oven, electric cooker, etc.

B. Water source is suitable for the sanitary standards, the water temperature and pressure is suitable. For getting the biggest efficiency, the inlet water temperature value should be $0.6\sim 32^{\circ}\text{C}$, and the pressure should be $0.138\sim 0.552\text{MPa}$.



C. There should be a sewer. While working, some of the water will be discharged, so the sewer is necessary. Furthermore, the sewer must be kept unblocked.

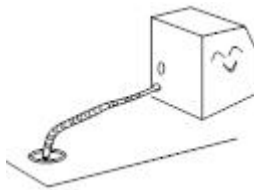

POWER SUPPLY

- a. Select the proper power supply according to the voltage and power on the nameplate.
- b. Connect the power wire and supply, ensuring the yellow and green wires were connected with the ground wire firmly.



Caution:

- a. For safety, ensure the ground connection is in good condition.
- b. All the exterior wires and other appliances must confirm with national standard.

- c. If the voltage fluctuation range is extensive ($\pm 10\%$ over the rated voltage), it will cause many faults, such as the machine can't be started, the electronic control board is damaged, or the compressor being damaged. Therefore, you must use a suitable automatic voltage regulator.

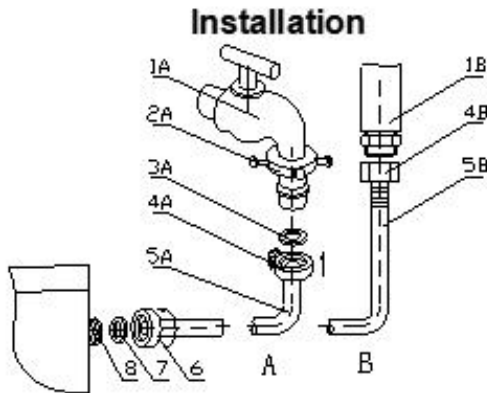

- | | |
|------------------|----------------|
| 1A. water faucet | 1B. water pipe |
| 2A. tie-in1 | |
| 3A. rubber band | 4A. tie-in2 |
| 4B. tube union | |

For the LB360T, LB440T, LB400TA, LB550TA, you must remove the decorative panel so as to turn on the power.

4. Connect the water supply pipe

Take out the water supply pipe from accessory bag, connect pipe's double ends to the water supply valve and water faucet. First, sleeve the connector 1 to the water faucet, then join one end of water supply pipe which has steel balls to the connector 1(hang on this water supply pipe's end, loose it after being connected to the connector 1), and connect the other end which is attached with a screw to the water supply valve, the valve also has a screw in its end, screw down the valve in clockwise. Once finished installation, check the connect part if it is leaks or not. you should connect the water pipes according to the diagram on the rear panel. The flow rate of condensate water is adjustable according to customers' need. (Condensate flow relates to the speed of making ice)



Warning: The water used to make edible ice block must be drinking water, furthermore, water's temperature must be among 0.6~32°C and the pressure among 0.138~0.552Mpa.

5. Connect the water discharge pipe

The water discharge pipe is situated at the back of the machine, extended pipe's end to the sewer.



Attention: In order to keep the water discharged smoothly, discharge pipe's lowest point must be above the highest point of the sewer, so to prevent the discharge water to flow back.

6. Keep the main body in level situation

Please keep the main body level to ensure the ice maker usually works. First, screw down the two adjustable legs into the machine's nuts. You can adjust the two legs properly if the main body is not level.

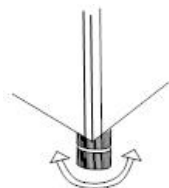

SERVICE INSTRUCTION

1. Operation process

First, turn on the water faucet, power, and water supply valve, then fill the sink with water, and turn off the faucet when the sink is filled with appropriate water.

2. Ice-make process

After several minutes, the water pump starts work, and the water will be pumped and flowed through the ice model evenly. At last, the ice is formed in the model. When the ice thickness sensor detects the regulated thickness of ice, the ice starts to drop.

3. Ice-drop process

The water pump stops working, the water supply valve will be opened, and water go into the sink. The heating valve will be turned on, and the refrigerant gas is led into the ice model; the ice root will be melted, and after about 2 minutes, the ice block drop into the ice cabinet. The falling ice block hit the retaining board (the inductive switch, which is fixed on the right side of the retaining board, till now, one circle is over, and the new ice-make circle will start.

4. Auto-stop

When the ice cabinet is filled with ice blocks, the continuing falling ice block will be locked between the retained board and evaporator; the retained board would be opened continually and couldn't return to the original position. After several seconds, the ice maker will stop working automatically. Once the ice block locked between the retained board and evaporator is taken away, the retained board will return to the its original position, and the ice maker will restart to make ice.

5. Running check

A、When the ice maker is in the working process, a sudden interruption of water supply can lead to the sink not being filled with appropriate water. The ice maker will turn into standby condition and not make ice as usual. After the water supply becomes normal and restart the machine, it can work normally.

B、 The fan motor for condenser is controlled by temperature, when condenser's surface temperature is lower, the fan motor will stop, so as to save power; when surface temperature rises up, the fan motor will work again, so fan motor work intermittently during the ice-make process.

C、 When a commercial ice maker works at a lower ambient temperature, the ice-drop process will be later than usual. If it occurs three times continuously, the machine will stop automatically, and the red light in the electrical box alternately flickers with the other four lights. After restarting the machine, it will become normal. Therefore, we suggest the user not use the machine at a low ambient temperature.

LCD FULL PAGE DISPLAY

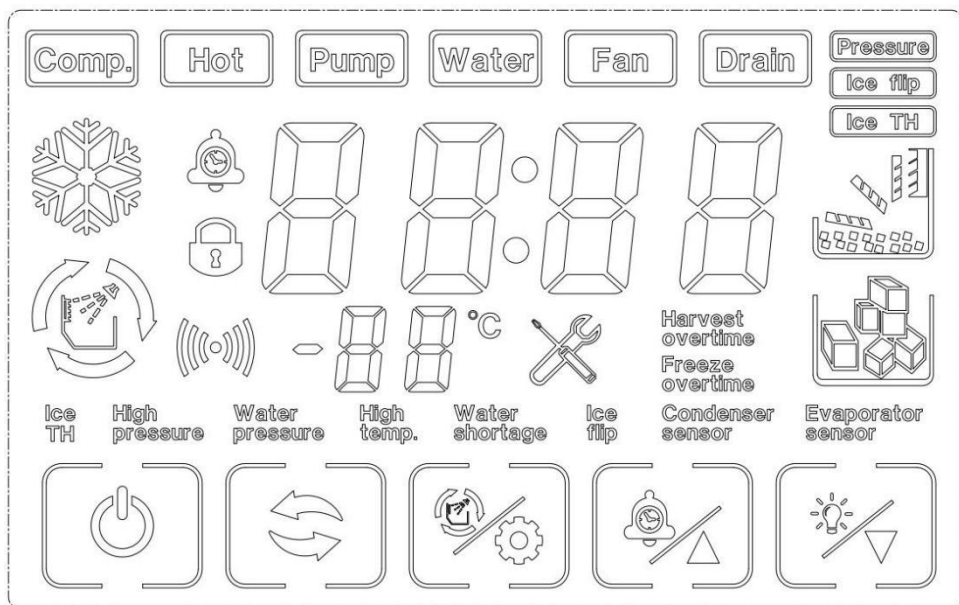

7. Buttons on display board

Boot / shutdown: 

press 3 seconds to turn off the machine under turn on status

press on/off button to turn on the machine under turn off status press the on/off button to exit setting under ice thickness setting and filling water adjust status

Mode button: 

Switch the ice making program

Clean / Set Button: 

Press to clean status under machine turn off status

+/reservation button: 

press to ice thickness adjust under pressure equilibrium、making ice、unload ice、ice full status

click to increase 1, long press the button to increase continuously under ice thickness adjust status

click to reservation time setting status under turn off status

-/light button: 

click to decrease 1, long press the button to decrease continuously under ice thickness adjust status

8. Fault codes

E-01.ice full button fault, skate board not back in position properly or ice full button damage

E-02.making ice over time,can't detect ice thickness 5 times continuously

E-03.unload ice over time,can't detect ice full button action within 6mintues unload ice 3times continuously

E-04.high temperature fault,condensation temperature higher than setting temperature

E-05.lack of water

E-06.high pressure

E-07.condensation sensor fault

Instruction: when the machine is in the “lack-water protection” condition, it can restart automatically after the sink is filled with appropriate water. If other faults cause the machine to stop, press the start button or supply power again after

forty-five minutes, and the machine will start again.

DAILY CLEANING AND MAINTENANCE

Clearance of side panels and inner container

A、 Before cleaning and sanitizing the ice maker, clean up the ice blocks in the cabinet and ensure the power source and water source has been cut off.

B、 Cleaning the side panels and inner container with clean water (you can join some neutral detergent in water), and then wipe the machine with a soft towel.

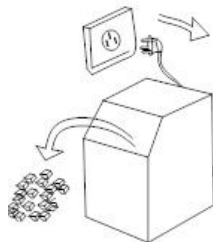

Attention: Do not spray water to machine directly. Alkaline detergent, perfumed soap, lapping powder, boiling water, bananas oil, tolpersion and most of the other organic solvents can't be used to clean the machine.



2. Dust removal of the condenser

To use the machine well, please clean the dust covering the condenser's fins once every three months. Open the ventilation fence in front of the machine (grasp the frame of the ventilation fence by hand, pull it out carefully), and use a dust collector or brush to clean the dust. Sharp iron tools must not be used to clean the condenser and must not damage the radiating fins.

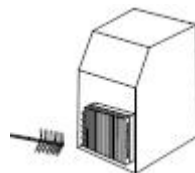

3. Cleaning the spray water pipe

A、 Cleaning the ice maker:

The spray water pipe must be cleaned once per half a year. When you clean it, firstly open the front cover, take out the spray pipe, and then scour off the scum till the every hole is unblocked. Reinstalled it after finish cleaning.

C、 After finishing washing, screw out the cap of the drain-valve and drain out all the dirty water, then tighten the cap.

C、 After finishing washing, screw out the cap of the drain-valve and drain out all the dirty water, then tighten the cap.

4. Automatically cleaning of the ice maker

Automatically cleaning the ice maker: when the machine is making ice, softly push the “clean” key on the electrical box, which is on the rear panel, the refrigeration system will stop working, and the machine turn into an auto-wash process. The wash process is divided into three steps: wash, potch, and drain. It will cost bout 30 minutes. To improve the cleaning effect, the user can add a little neutral detergent, and after finishing washing, the machine turns into ice-make condition automatically.

5. Clean the split type commercial ice maker and auto-clean series ice maker.

Button “AN(MODE)” on the PC board: After pressing the button “AN(MODE)”, the machine will stop current working process and turns into next.

Working process: power supply—filling

water—balance—pre-cooling—refrigerating—collecting ice—ice is full

Switch on the power source and clean

A、 Usually, the machine is connected to the power source continually. When you connect the machine to the power source firstly, there is a clean process after the water in the sink is full: water supply—water pump works —water pump works and drain-valve opens—water supply—water pump works—water pump works and drain-valve opens—pressure balances. This process will take about 5 minutes(once every 30 ice-make cycles). In addition, after every four ice-make cycles, there is a draining process, draining out the water in the sink.

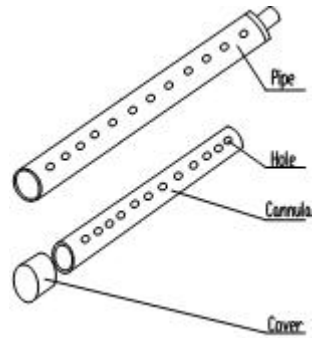

B、 After finishing washing, confirm the place of the float ball: If the float ball is on the bottom and the machine is on, this condition is normal, the program will turn into pressure balance process, the water level will be controlled automatically; If the float ball is on the upper position and the machine stops, it means that there are some problems with the water level sensor, water pump or drain valve.

Point: the water-filter core is consumable, it is not in the guaranteed scope. If you need it, please contact with our marketing department and buy it.

Please according to the following steps if you haven't used the machine for a long time. Turn off the power switch, remove the machine's plug, then cut off the power supply and water supply.

B、 Take out the ice block from the cabinet, wipe out the water on the inner of the cabinet.

C、 Wipe out the water on the cabinet, then open the door and dry the cabinet.

TROUBLE SHOOTING

Fault	Analysis	Solution
Do not make ice	The electric wire didn't connect well.	Check the wire.
	The retained board was pinned by ice block.	Take out the ice block so as to let the retained board return to the original situation.
	The connecting wire of compressor's starter is loose	Check and fasten it
	The starting capacitor of compressor is broken	replace it
	PC board is broken	replace it
	Water level sensor is broken	replace it
	Water pump is broken	replace it
The sink is	Water supply solenoid valve is	replace it

overflow.	broken	
	Water level sensor is broken	replace it
No water flowing on to the ice model	Water pump is broken	replace it
	PC board is broken	replace it
The ice block is thin	The surface of condenser is covered with dust.	clean it
	The ambient temperature is too high	You should use the machine in allowable ambient temperature
	The refrigerant leak	check and recharge the refrigerant
	Fan motor is broken	replace it
	Spray tube is blocked	clean it
	The ice thickness sensor is too close to the ice model.	Adjust the screw of sensor(turn right)
The ice can not drop off.	The ice thickness sensor is broken	replace it
	The solenoid valve is not open	check the electric wire if it is connected well or not. Or replace the solenoid valve
	The ambient temperature is too low	you should use machine in allowable ambient temperature

TECHNICAL PARAMETER AND WIRING DIAGRAM

A、Technology parameters are on the nameplate.

B、The electrical schematic diagram is on the inner side of the board .

VEVOR[®]

TOUGH TOOLS, HALF PRICE

Technical Support and E-Warranty Certificate

www.vevor.com/support

Made In China