

HOME
DECORATORS
COLLECTION®

⚠ WARNING: DO NOT USE A DIMMABLE OUTLET OR DIMMER SWITCH WITH THIS PRODUCT. Use of a dimmable outlet or dimmer switch can cause overheating and/or melting of the product and pose a potential burn hazard.

Item #1006193041
Model #21LE31010

USE AND CARE GUIDE

9FT GRAND DUCHESS TWINKLING BALSAM FIR LED PRE-LIT TREE

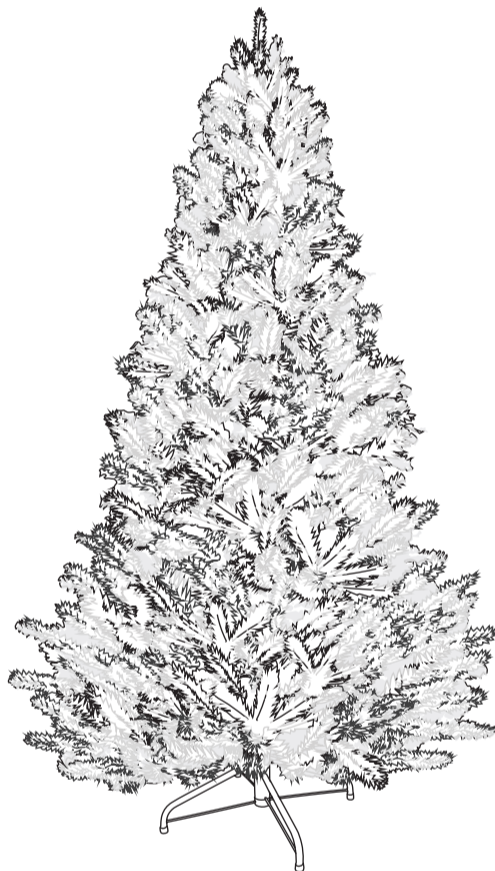

Questions, problems, missing parts?
Before returning to the store, call HOME DECORATIONS COLLECTION Customer Service
8 a.m. - 7 p.m., EST, Monday - Friday, 9 a.m. - 6 p.m., EST, Saturday

1-800-986-3460

HOMEDEPOT.COM

THANK YOU

*We appreciate the trust and confidence you have placed in HOME DECORATIONS COLLECTION through the purchase of this 9FT GRAND DUCHESS TWINKLING BALSAM FIR LED PRE-LIT TREE. We strive to continually create quality products designed to enhance your home. Visit us online to see our full line of products available for your home improvement needs.
Thank you for choosing HOME DECORATIONS COLLECTION!*

When using electric products, basic precautions should always be followed including the following:

READ AND FOLLOW ALL SAFETY INSTRUCTIONS.

- Do not use seasonal products outdoors unless marked suitable for indoor and outdoor use. When products are used in outdoor applications; connect the product to a Ground Fault Circuit Interrupting (GFCI) outlet. If one is not provided, contact a qualified electrician for proper installation.
- This seasonal use product is not intended for permanent installation or use.
- Do not mount or place near gas or electric heaters, fireplaces, candles or other similar sources of heat.
- Do not secure the wiring of the product with staples or nails, or place on sharp hooks or nails.
- Do not let LEDs rest on the supply cord or on any wire.
- Unplug the product when leaving the house, when retiring for the night, or if left unattended.
- This is an electric product not a toy! To avoid risk of fire, burns, personal injury and electric shock, it should not be played with or placed where small children can reach it.
- Do not use this product for other than its intended use.
- Do not hang ornaments or other objects from cord, wire, or light string.
- Do not place lighting string on carpeting, drapes, furniture, or allow it to contact vinyl siding while the power is on.
- Do not perform any maintenance or troubleshoot for bad or broken LEDs while the power is on.
- Do not close doors or windows on the product or extension cords as this may damage the wire insulation.
- Do not cover the product with cloth, paper or any material not part of the product when in use.
- To reduce the risk of fire and electric shock: a) Do not install on trees having needles, leaves or branch coverings of metal or materials which look like metal, and b) Do not mount or support strings in a manner that can cut or damage wire insulation.
- Read and follow all instructions that are on the product or provided with the product.

SAVE THESE INSTRUCTIONS

USE AND CARE INSTRUCTIONS

- When the product is placed on a live tree, the tree should be well maintained and fresh. Do not place on live trees in which the needles are brown or break off easily. Keep the tree holder filled with water.
- If the product is placed on a tree, the tree should be well secured and stable.
- Before using or reusing, inspect product carefully. Discard any products that have cut, damaged, or frayed wire insulation or cords, cracks in the LED holders or enclosures, loose connections or exposed copper wire.
- When storing the product, carefully remove the product from wherever it is placed, including tree branches, or bushes to avoid any undue strain or stress on the product conductors, connections, and wires.
- When not in use, store neatly in a cool, dry location protected from sunlight.

Safety Information (continued)

This device complies with Part 15 of the FCC Rules.

Operation is subject to the following two conditions:

- (1) this device may not cause harmful interference, and
- (2) this device must accept any interference received, including interference that may cause undesired operation.

Please note that changes or modifications of this product is not expressly approved by the party responsible for compliance could void the user's authority to operate the equipment.

NOTE: This equipment has been tested and found to comply with the limits for a Class B digital device, pursuant to Part 15 of the FCC Rules. These limits are designed to provide reasonable protection against harmful interference in a residential installation. This equipment generates, uses and can radiate radio frequency energy and, if not installed and used in accordance with the instructions, may cause harmful interference to radio communications. However, there is no guarantee that interference will not occur in a particular installation. If this equipment does cause harmful interference to radio or television reception, which can be determined by turning the equipment off and on, the user is encouraged to try to correct the interference by one or more of the following measures:

- Reorient or relocate the receiving antenna.
- Increase the separation between the equipment and receiver.
- Connect the equipment into an outlet on a circuit different from that to which the receiver is connected.
- Consult the dealer or an experienced radio/TV technician for help.

Responsible Party- U.S. Contact Information:

Company: HOME DEPOT INC

Address: 2455 PACES FERRY ROAD ATLANTA, GA 30339

Customer service toll-free Number : For Home Decorators Collection call 1-800-986-3460

FCC MODEL #: DPSR29-S3400

Safety Information (continued)

 **CAUTION:** Do not replace or modify any connectors on this product. Discard product if connector is damaged. Make sure connectors are fully inserted and any connector rings are twisted until completely secured such that the ring can no longer be turned and the two portions of the connector are completely assembled.
Do not use a dimmer switch or install any additional Christmas lighting or ornamentation that is powered by a light bulb socket. Doing this may result in damage to your light string or cause personal injury. This action will result in a void of the limited warranty of this product.

BATTERY INSTALLATION:

- Carefully remove the remote from the packaging.
- Remove the slide plate located on the back of the remote control.
- Insert 2 x AAA batteries by aligning the appropriate (+/-) markings accordingly.
- Replace the slide plate on the back of the remote control.

CAUTION:

- Do not operate this product while it is still in the packaging.
- Never mix old and new batteries (OR different types of batteries).
- Do not mix alkaline, standard (carbon-zinc), or rechargeable (Ni-MH, Ni-CD, etc.) batteries or equivalent.
- Battery is to be inserted with the correct polarity.
- 2 x AAA batteries are included.
- Exhausted battery is to be removed from the battery holder.
- The supply terminals are not to be short circuited.
- Do not throw battery into fire.
- Battery should never be left in the product when not in use for long periods of time.
- Never allow any plastic part to come in contact with a source of heat or flame.
- This is a Christmas decoration. This is not a toy. Keep out of the hands of small children.

DISPOSAL AND RECYCLING:

Waste electrical products should not be disposed of with household waste. Please recycle where facilities exist. Check with your local authority or retailer for recycling advice. This applies to the battery also.

Warranty

LIMITED WARRANTY

This product is warranted to be free from defects in workmanship and materials for up to three seasonal years from date of purchase. If it fails to do so, please contact the Customer Service Team at 1-800-986-3460 or visit www.HomeDepot.com.

 **WARNING: DO NOT USE A DIMMABLE OUTLET OR DIMMER SWITCH WITH THIS PRODUCT.**
Use of a dimmable outlet or dimmer switch can cause overheating and/or melting of the product and pose a potential burn hazard.

Questions, problems, missing parts? Before returning to the store,
call HOME DECORATORS COLLECTION Customer Service
8 a.m. - 7 p.m., EST, Monday-Friday, 9 a.m. - 6 p.m., EST, Saturday

1-800-986-3460

HOMEDEPOT.COM

Retain this manual for future use.

Document #: 21LE31010

Pre-Assembly

BEFORE YOU BEGIN

We recommend wearing proper clothing in order to prevent scratches that may occur during the assembly process.

Carefully unpack the contents from the tree's carton. If any part is missing or damaged, do not assemble this product. Contact Customer Service.

ASSEMBLY DETAILS

Estimated assembly time: 5 minutes

Number of people required: 1-2

No tools are required

PACKAGE CONTENTS

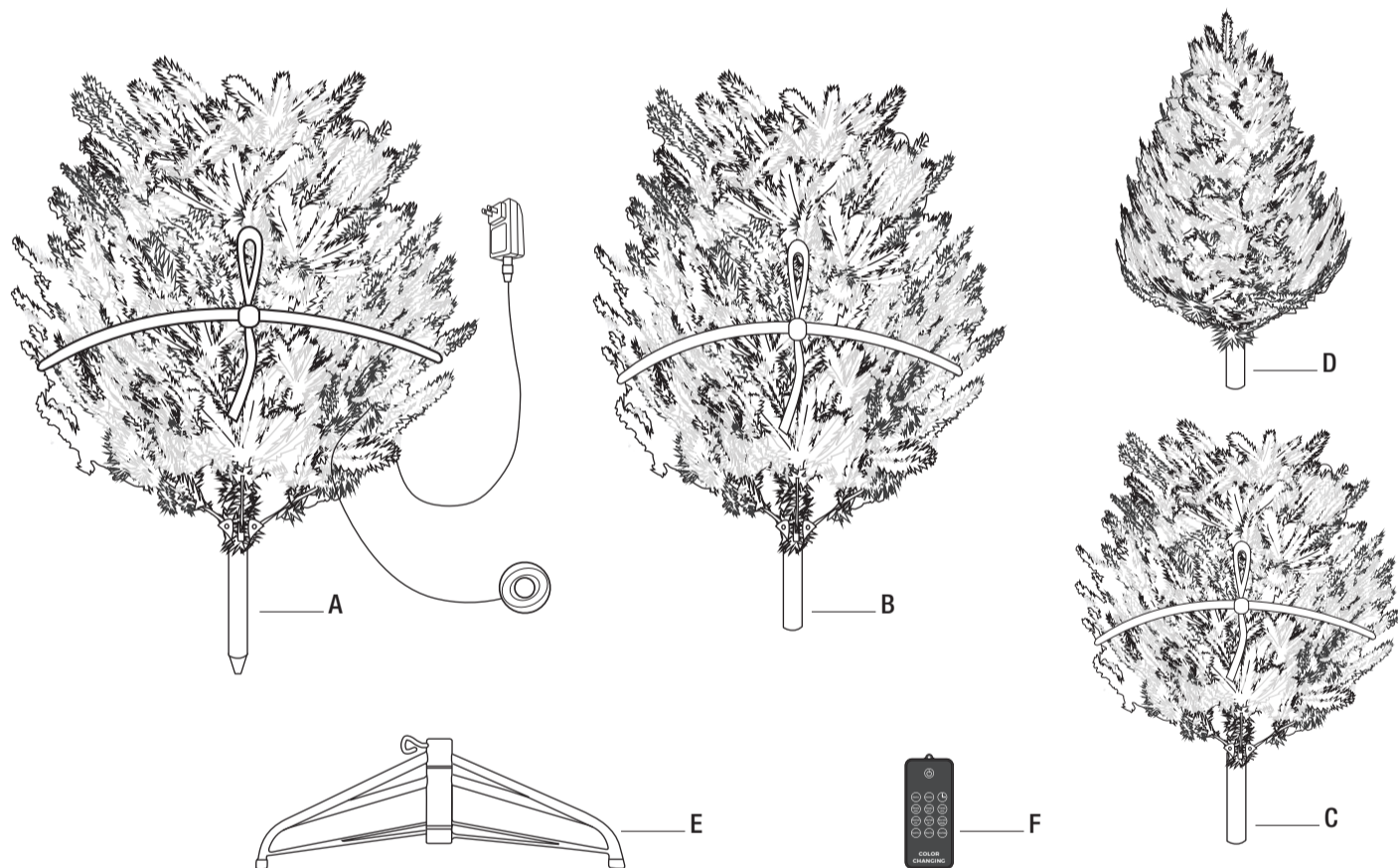

Part	Description
A	Tree Section A - Labeled "A" (Contains an on/off push button foot pedal with cord and plug)
B	Tree Section B - Labeled "B"

Part	Description
C	Tree Section C - Labeled "C"
D	Tree Section D - Labeled "D"
E	Tree Stand (With single eye-bolt)
F	Remote Control (With 2 x AAA batteries included)

Assembly

1 Assembly of the Tree Stand

- Remove the tree stand (E) from the plastic bag, loosen the eye bolt and open the tree stand (E) to form an "X".
- Align the hole for the insertion of the eyebolt.
- Insert the eyebolt and begin threading in a clockwise direction for a couple of rotations only; leaving enough room for the tree's pole from section (A) to be inserted into the assembled stand.
- Place the tree stand (E) in its desired location; as once the tree is fully assembled, it may become too difficult to move and relocate.

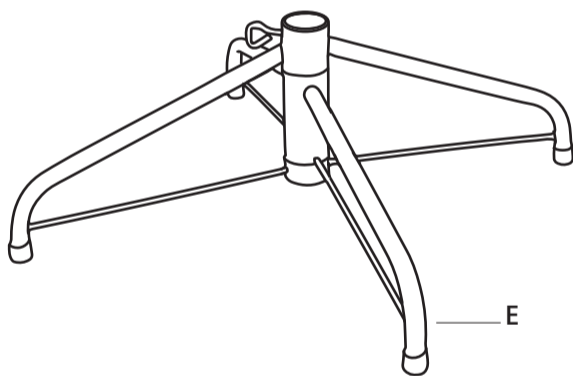

2 Assembly of the Tree

- Locate the bottom section of the tree (A) which is identified by a label on the outer branches marked "A".
- Remove the protective plastic cap from the end of the pole, (that is pinched to a point), and place that end into the tree stand (E). Be sure that the pointed end of the pole extends to the bottom of the stand.
- Now tighten the eyebolt on the tree stand (E); being careful not to over-tighten.
- Untie and remove the fabric strapping bounding the branches upright. Caution: DO NOT CUT.
- Gently guide the branches downward into place.
- Beneath the canopy of section (A), contain's an on/off push button foot pedal with cord and plug. Remove the twist-tie binding the cord together and insert the plug into a working electrical outlet. Section (A) will now be lit. If section (A) fails to light - press the On/Off push button foot pedal - as it may be in the "Off" position.

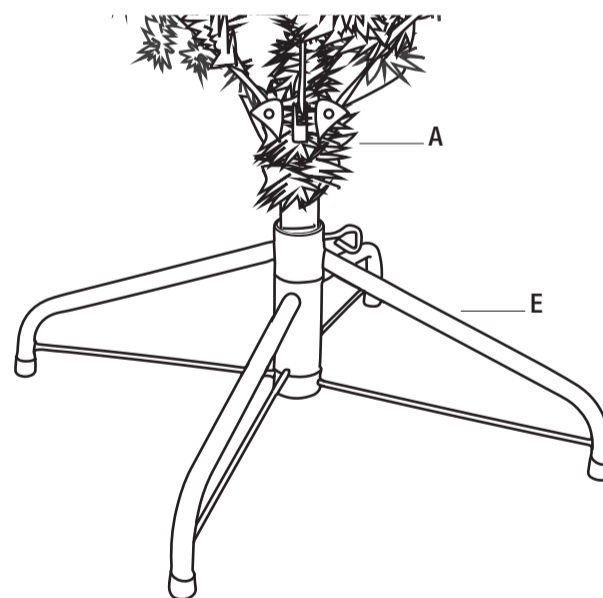

Assembly (continued)

3

Push button foot pedal operation:

- The push button foot pedal is provided for the tree's On/Off operation; as well as for operating the tree's 9 available lighting functions. Simply push the foot pedal's button to select your favorite color and or lighting function.

POWER POLE TECHNOLOGY

NOTE: Your tree has been designed with Power Pole technology; allowing for each of the tree's remaining sections to light up automatically, upon a firm insertion of each lettered section.

- Locate the next section of the tree which is identified by a label on the outer branches marked (B).
- Remove the protective plastic cap from the end of the pole on section (B); insert that end onto the top of the pole of section (A).



- Once section (B) is fully inserted downward into section (A); both section (A) and section (B) will now be lit.
- Again, untie and remove the fabric strapping bounding the branches upright. Caution: DO NOT CUT.
- Gently guide the branches of section (B) downward into place.

4

- Locate the next section of the tree which is identified by a label on the outer branches marked (C).
- Remove the protective plastic cap from the end of the pole on section (C) insert that end onto the top of the pole of section (B).
- Once section (C) is fully inserted downward into section (B). Section (A), (B) and (C) will now be lit.
- Again, untie and remove the fabric strapping bounding the branches upright. Caution: DO NOT CUT.
- Gently guide the branches of section (C) downward into place.
- Locate the top section of the tree which is identified by a label on the outer branches marked (D).

- Insert the top section (D) onto the top of section (C).
- Once Section (D) is fully inserted downward into section (C) your entire tree will now be lit.
- Gently guide the branches of section (D) downward into place. Assembly is now completed. Proceed to spread & fluff the branch tips, to further enhance the tree's appearance, if needed.

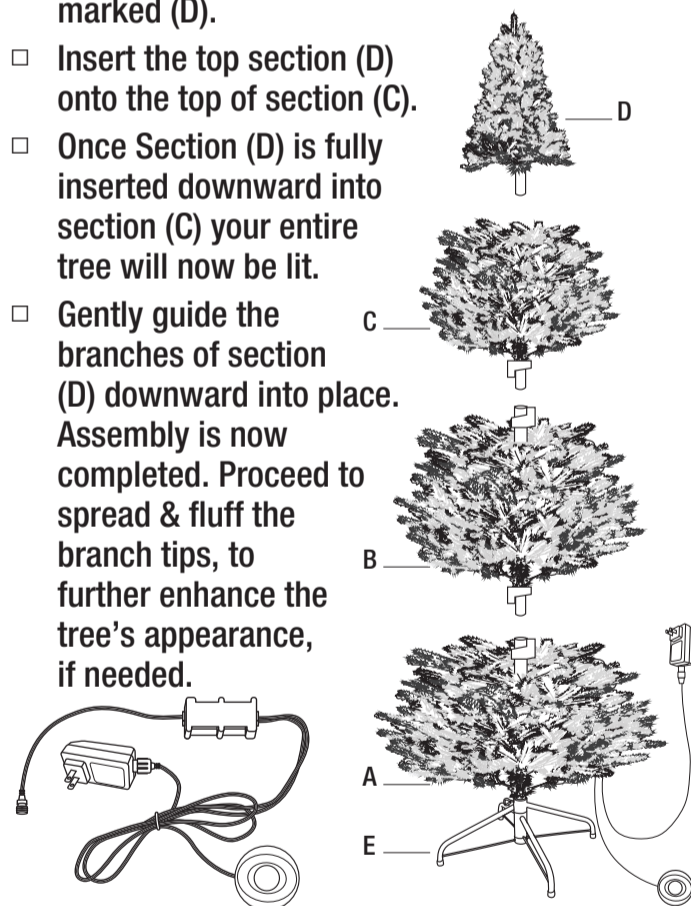

Additional Features

5

REMOTE CONTROL OPERATION

Your Pre-Shaped & Pre-lit LED Christmas Tree's 9 lighting functions are controlled by the use of the remote control (F) provided, or by your smartphone or tablet - by downloading the App!



SELECTING COLOR & FUNCTION

Simply press a desired lighting function button - Per the 9 listed lighting functions below.

Demo

1. Steady Warm White
2. Steady Multi
3. Twinkle Warm White
4. Slow Fade Warm White
5. Slow Fade Multi
6. Slow Color Variable
7. Fast Flip Warm White to Multi
8. Slow Flip Warm White to Multi
9. Slow Fade Warm White to Multi

Please Note: The "Demo" selection is only accessible by App only. (Which continually runs through all of the tree's 9 lighting functions).

6

IMPORTANT: Activate your tree's lighting system to "Home" mode usage!

- **Noting:** Your tree is currently SET in "Store" mode, and will automatically run through ALL of the tree's available 9 lighting functions.
- To SET your tree's lighting system to "Home" mode - so that your tree will respond & maintain onto 1 of the tree's 9 available lighting functions - please follow the steps & options below.
 - 1) Press & hold the "Demo" button located on the remote control (F) for 3 seconds - your tree's lights will flash 5 times in warm white color - indicating that your tree is now under "Home" mode manually operation. (Now, when 1 of the 9 available lighting functions is selected, your tree will maintain the lighting function selected until your decision to manually change again).

- 2) Option #2: Press & hold the button located on the tree's foot pedal for 3 seconds - your tree's lights will flash 5 times in warm white color - indicating that your tree is now under "Home" mode manually operation. (Now, when a lighting function is selected, by remote control or App only, your tree will maintain the lighting function selected until your decision to manually change again).

Note: If the "Demo" button, and or the tree's foot pedal is pressed & held again for 3 seconds, (The tree's lights will flash 5 times in multi color), the tree's lighting system will now revert back to "Store" mode operation, and will now run through ALL of the tree's available 9 lighting functions continually.

NOTE: When you are operating the tree's colors & functions by the APP; the tree will automatically convert to "HOME" mode operation.

Additional Features (continued) | Disassembly & Storage

7

DIMMER FEATURE:

- The Dimmer button enables for the selection of your preferred level of brightness - low, medium or high.

TIMER FEATURE:

- Press the “Timer” button; the trees lights will flash WARM WHITE 3 times – Indicating that the 6 hour “On” / 18 hour “Off” timer has now been activated.
- Note: The tree’s lights will automatically resume back to the “On” position – 24 hours from when it was initially activated.
- Press the “Timer” button again, the trees lights will flash MULTI 3 times – Indicating that the timer feature has now been deactivated.
- Note: The trees On/Off operation is now controlled by either the manual operation of the remote control, foot-pedal control or by the App!

- Gently remove the plug from its electrical outlet, and carefully bind the cord which contains the on/off push button foot pedal and plug.

- Beginning with the tree’s top section; lift each section straight up from the section below, and continue working downward.

NOTE: You may have to slightly wiggle each section as you lift each section upward.

- To remove the bottom and final section; loosen the eyebolt by turning in a counter-clockwise direction and lift section (A) from the support collar of the tree stand.

- Gently fold the branches of each section upward, towards the center and position in the storage container.

NOTE: With the exception of the tree’s “top” section; by holding each section upside down; the branches will collapse downward, due to the hinging, aiding in the packing of each section into the storage container.

- Unthread the eyebolt from the tree’s stand and fold together; placing in the storage container.

- Replace the plastic protective caps on the pole’s ends before placing in carton.

- It is recommended to always store the tree in a cool, dry location protected from excessive exposure to heat or sunlight.

NOTE: Store your remote control in a SAFE & DRY location and remove the batteries from the remote control before storage.

NOTE: ALTHOUGH THE LED LIGHT STRINGS ON THE TREE ARE RATED FOR INDOOR OR OUTDOOR USE; THE COMBINATION OF THE TREE WITH THE LED LIGHTS IS FOR INDOOR USE ONLY.

Download the “LEDUP” APP!

1st: Scan the QR code to download the “Ledup” app onto your smartphone or tablet.

2nd: Now that the App is installed; scan the QR code again or input the Product ID: **nctr010f** to link the App to your tree - It is that easy!

NOTE: You need to enable *Bluetooth on your smartphone or tablet to use the Ledup App.

You can now control your tree’s 9 lighting functions by either the remote control, smartphone or tablet.

NOTE: When you are operating the tree’s colors & functions by the APP; the tree will automatically convert to “HOME” mode operation.



Scan the QR code to download the remote App!

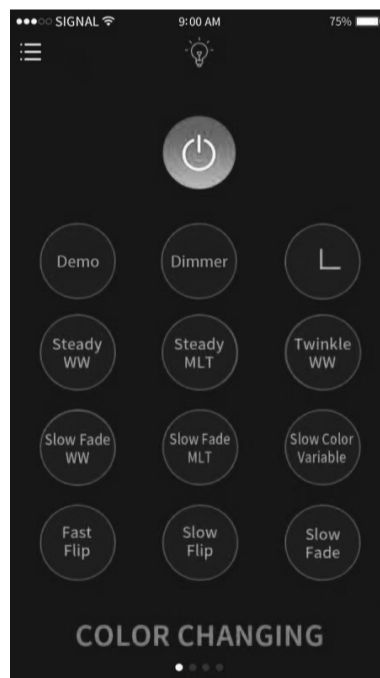

Phone screen

* Bluetooth protocol is not being used to communicate with the tree. A 2.4 GHz frequency transmitter/receiver is being used to communicate with the tree.

Troubleshooting

- If the tree does not illuminate press the on/off button  on your remote control. If failure to light persists, the battery may need to be replaced. Insert 2 x AAA batteries.

NOTE: The tree's 9 available lighting functions are controlled by the remote control provided or by your smartphone or tablet - by downloading the App.

NOTE: By reducing the distance from your tree; you may achieve better remote control and App reception.

If the tree fails to light due to a damaged or defective remote control; please resort to App operation until a new remote control can be provided. NOTE: Replacement parts can be acquired through our customer service center at 1-800-986-3460.

- If failure to light persists, press the on/off push button foot pedal; as it may be in the "Off" mode.
- If an individual lettered tree section does not illuminate, remove each section and then reinsert as instructed, to ensure the electrical connection is made.
- Upon making a color or function selection - by the use of the remote control - If the tree defaults to a "Demo" / demonstration operation - whereas the tree does not remain on the color or function that was selected - set the remote control for "Home" use (Manual operation) - By following the steps for "Remote Control Operation" located on page 9 of this instruction manual.
- If a light set, section or area fails to light. Simply check the coaxial connections - along the entire length area of the Quick Set[®] pole.
- Always ensure that the electric outlet to be used; is functioning & working as it is intended.

NOTE: A SPECIALTY NON-REPLACEABLE LED HAS BEEN APPLIED TO YOUR PRE-LIT TREE; IN THE CASE THAT A INDIVIDUAL LED BULB BURNS OUT, THE REMAINING LED BULBS WILL CONTINUE TO SHINE.

<p>A PRE-LIT TREE SECTION IS OUT?</p>  <p>Firmly insert each section downward.</p>	<p>THE TREE IS JUST NOT FULL ENOUGH?</p>  <p>Simply spread the branch tips upward and outward.</p>	<p>ACTIVATE YOUR REMOTE CONTROL!</p>  <p>Press & hold the "Demo" button located on the remote control for 3 seconds - your tree's lights will flash 5 times in warm white color - indicating that your tree is now under "Home" mode manually operation.</p> <p>You are now all set!</p>
<p>A LIGHT SET OR AREA IS OUT?</p>  <p>Simply check the connections along your Quick Set[®] pole.</p>	<p>Concerns/ Questions?</p> <p>Please Call</p> <p>1-800-986-3460</p>	