

Galanz

Model# GRSK2A15BEMA18
Toaster Oven User Manual



Thank you for purchasing a Galanz product. Please read this manual carefully for correct usage and safety, and keep for future reference. For service, support and warranty information, call 800-562-0738.

@2020 Galanz Americas Limited Company.

CONTENTS

Important Safety Instructions	2
Warning	2
Read before using	3
Grounding Instructions	4
Electrical Connections	4
Installation Guide	5
Important Tips	5
Product Diagram	6
Control Panel	7
Operation Instructions	8
Dehy	8
Toast	9
Air Fry	10
Bake	11
Rotiss	12
Broil	13
Pizza	14
Conv	15
Product Warranty	16

IMPORTANT SAFETY INSTRUCTIONS

WARNING

When using this appliance, some safety tips should always be followed. They include:

- Read all instructions carefully before using the appliance.
- The temperature of a working oven or a just used one could be very high, to avoid getting burned, do not touch.
- Close supervision is always necessary when this or any appliance is used near children. Do not place this appliance within reach of children.
- To prevent electric shock, do not immerse the power cord, the plug or any other parts of the appliance in water.
- Do not hang the power cord over the edge of a counter-top or near hot surfaces.
- Check the unit frequently for damages to the power cord, the plug or any other parts. If any damage is found, stop using the unit and take it to the nearest maintenance or repair center.
- Make correct and appropriate use of the accessories to prevent any man made damage.
- Do not put the toaster oven in a high-temperature environment. Please keep the toaster oven away from heat sources such as heating appliances or fire.
- When using the toaster oven, pull the unit out a minimum of ½ inch away from walls on all sides.
- Always unplug the oven after using or before cleaning. Let the appliance cool down completely before moving or cleaning.
- Do not cover the oven with metal foil, this will cause overheating of the appliance.
- Please take caution when removing hot foods, cookware or accessories.

- Please do not attempt to cook oversized foods in the toaster oven. Cooking foods that are not proportionally correct to the size of the cavity could cause fires or electrical shock.
- A fire may occur if the toaster oven is covered or comes in contact with flammable materials including curtains, draperies and walls etc., when in operation.
- Do not place any flammable materials in oven, such as paper, cardboard, plastic or anything that may catch fire or melt.
- Do not store any materials other than manufacturer's recommended accessories in this unit when not in use.
- To turn this appliance off, shut off all function settings before unplugging it.
- Please use oven mitts when inserting or removing hot items from the oven.
- Please take caution when opening or closing the tempered glass door. There is a chance it may break due to improper usage. Please do not scratch or use sharp or abrasive cleaning supplies on the glass. If there's any scratches or nicks, stop using it and contact Galanz at 1-800-562-0738.
- Please operate the appliance in a well ventilated area. Please do not use outdoors.
- The product is intended for normal household use only. Do not use it for other unintended purposes.
- Place less than 3.5 lbs of food evenly onto the baking or roasting tray.
- Please be careful when lifting or moving the appliance as there might be some sharp edges.

IMPORTANT SAFETY INSTRUCTIONS

- Please do not put any objects on the glass door as this can damage the glass or hinges.
- Be careful not to be burned by hot surfaces of the working oven.
- This is a Y-connection appliance. Damage to the power cord needs to be fixed by professionals.
- Do not operate the appliance with an external timer or a separate remote control system.
- Unplug from outlet when not in use and before cleaning. Allow to cool before putting on or taking off parts.

CAUTION: BE CAREFUL TO AVOID SCALDING BY THE HOT SURFACES!

READ BEFORE USING

- this is your first time using this appliance, please be sure to:
 - Read this manual carefully before using the appliance.
 - Remove protective film and sticker from the surface of the oven. Open oven door and remove all printed documents and papers from inside.
 - Check and clean all accessories before using. Dry all accessories thoroughly before inserting them back in. Connect the appliance with a power source, when it is ready for use.
- Before using for the first time, preheat the oven at its maximum temperature for 15 minutes to eliminate any manufacturing residue that may remain after shipping. It is normal to experience some smoke coming out.

IMPORTANT SAFETY INSTRUCTIONS

GROUNDING INSTRUCTIONS

This appliance must be grounded. In the event of an electrical short circuit, grounding reduces risk of electric shock by providing an escape wire for the electric current. This appliance is equipped with a cord having a grounding wire with a grounding plug. The plug must be plugged into an outlet that is properly installed and grounded.

Consult a qualified electrician or serviceman if the grounding instructions are not completely understood, or if doubt exists as to whether the appliance is properly grounded, and if it is necessary to use an extension cord, use only a 2-wire extension cord that has a 2-blade grounding plug and a 2-slot receptacle that will accept the plug on the appliance. The marked rating of the extension cord shall be equal to or greater than the electrical rating of the appliance.

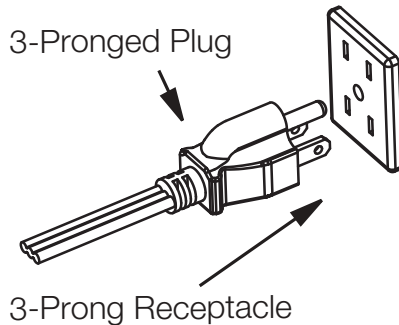

⚠ ELECTRICAL CONNECTIONS

A short power cord is provided to reduce risks of becoming entangled or tripping over a long cord, an extension cord may be used if care is exercised in its use.

- The electrical rating of the extension cord must be at least as great as the appliance. The extension cord must be arranged so that it will not drape over the counter-top or table-top where it can be pulled on by children or tripped over unintentionally.
- Fixing and replacement of the power cord must be done by professionals from the manufacturer's maintenance department or the relevant department.

SAVE THESE INSTRUCTIONS

IMPORTANT SAFETY INSTRUCTIONS

INSTALLATION GUIDE

- Make sure that all the packing materials are removed from the inside of the toaster oven.
- This oven must be placed on a flat, stable surface.
- For correct operation, the oven must have sufficient airflow. Allow minimum 20cm of free space necessary above the top surface of the oven and 5cm at both sides. Do not cover or block any openings on the appliance. Do not remove feet.
- The appliance shall be only used on a countertop over 3 feet (914mm) above the floor.
- Do not place the oven where heat, moisture, or high humidity are generated, or near combustible materials.

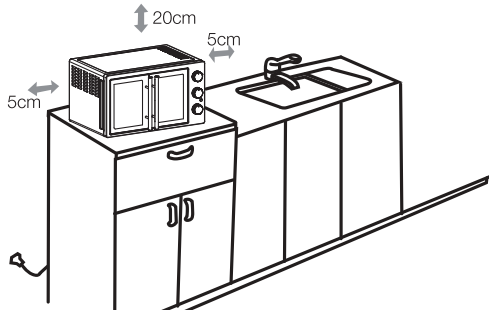

- Make sure that the power cord is undamaged and does not run under the oven or over any hot or sharp surfaces.
- The socket must be readily accessible so the toaster oven can be easily unplugged in an emergency.

IMPORTANT TIPS

- For gourmet results please cook food that has already been defrosted.
- Frozen food and thick cut meat take longer to cook.
- Use the baking and roasting tray to cook foods containing liquids or fat to protect the heating elements from damage.
- Be careful when opening the toaster oven door as hot air can escape and cause burns.
- Make sure to use the crumb tray and clean the toaster oven regularly.
- Do not do any cooking with the door open.
- Do not place any accessories or cookware on top or in contact with the heating elements.
- Condensation is normal and can be seen on the glass door as the toaster oven heats up to the set temperature.

Power supply	120V/60Hz
Rated Power	1800W
Outside Dimensions	21.6 X 19.3 X 12.9 inches
Oven Capacity	1.5 Cu.Ft.
Net Weight	Approx.24.2 lbs

PRODUCT DIAGRAM

1. Oven Rack

Place your oven safe cookware here.

2. Air Fry Rack

Use this for Air Frying foods like chicken wings or cutlets.

3. Baking and Roasting Pan

For baking and roasting meat, fish and other foods. You can also utilize this pan to catch drippings during Air Fry and Rotisserie programs.

4. Rotisserie Removal Tool

For removing the rotisserie spit.

5. Air Fry Basket

For Air Frying smaller foods like chicken nuggets or french fries.

6. Rotisserie Spit

For roasting chicken and other kinds of meats.

7. Crumb Tray

For collecting small amounts of oil or food crumbs.

8. Glass Doors

Transparent doors allow you to see food cooking. They are made of tempered glass which is more durable.

⚠ **Housing:** Please note the housing gets hot during operation.

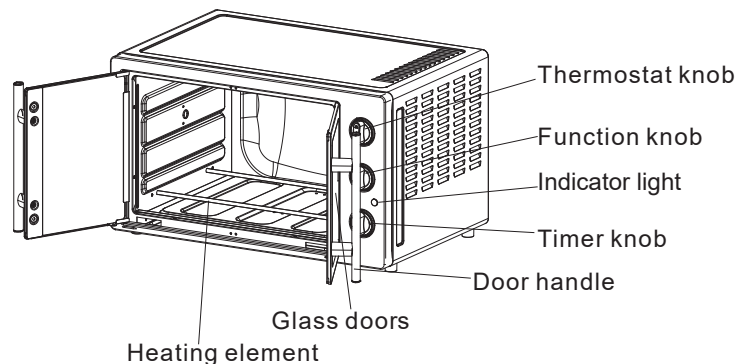

NOTE: There might be a slight difference of the product you bought from the above diagram.

CONTROL PANEL

CONTROL PANEL

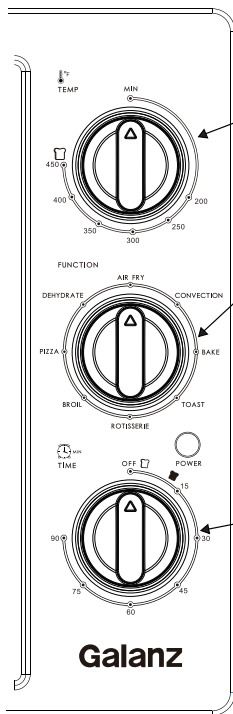

Temperature Control Knob
Select the desired temperature.

Function Selector Knob
Select cooking function by rotating knob to desired setting.
Dehy (See Page 8)
Toast (See Page 9)
Air Fry (See Page 10)
Bake (See Page 11)
Rotiss (See Page 12)
Broil (See Page 13)
Pizza (See Page 14)
Conv (See Page 15)

Timer Control Knob with Audible Signal
Set cooking time up to 90 minutes. Unit will automatically turn the toaster oven off when it reaches "OFF" at the end of the cooking time.



NOTE

It is suggested to only use the appliance for 40 minutes in a two hour period.

OPERATION INSTRUCTIONS

Dehy



Accessory Guide:



For Dehydrate function, suggested cooking temperature can not be selected. The recommended temperature is 200F. In order to reach desired results you may need to cook on this function in multiple batches, cooking 90 mins at a time.

Example: Use Dehydrate function to cook for 90 minutes.

1 In standby mode, rotate the **FUNCTION** knob to choose Dehy program.



FUNCTION

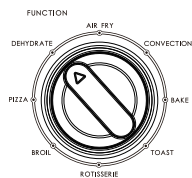

2 Rotate the **TEMP** knob to choose 200°F.



TEMP

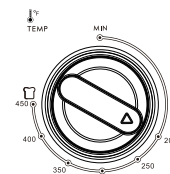

3 Rotate the **TIME** knob to choose 90 minutes



MIN
TIME

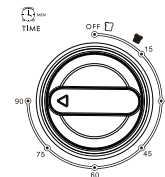

OPERATION INSTRUCTIONS

Toast



Accessory Guide:



For Toast function, three browning levels can be selected.

Example: Toast to Level 3 of Browning.

1 In standby mode, rotate the FUNCTION knob to choose Toast program.



FUNCTION

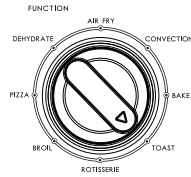

2 Rotate the TEMP knob to choose 450F.



TEMP
°F

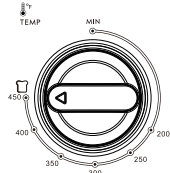

3 Rotate the TIME knob to choose Level 03



MIN
TIME

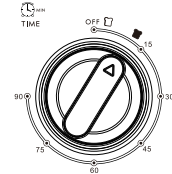

Level of Browning	Longest cooking time
01	2:00
02	6:00
03	12:00

OPERATION INSTRUCTIONS

Air Fry



Accessory Guide:

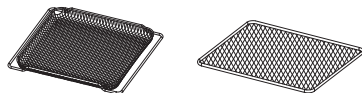

For Air Fry function, suggested cooking temperature can be selected between 350°F and 400°F. The suggested longest cooking time is 90 minutes.

Example: Use Air fry function to cook for 30 minutes at 375°F.

1 In standby mode, rotate the FUNCTION knob to choose Air fry program.



FUNCTION

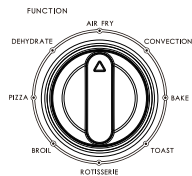

2 Rotate the TEMP knob to choose 375°F.



TEMP

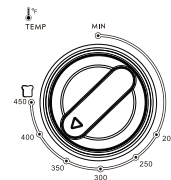

3 Rotate the TIME knob to choose 30 minutes



TIME

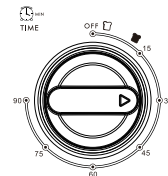

OPERATION INSTRUCTIONS

Bake



Accessory Guide:

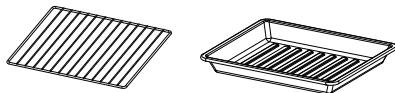

For Bake function, suggested cooking temperature can be selected between 200°F and 450°F. The suggested longest cooking time is 90 minutes.

Example: Use Bake function to cook for 40 minutes at 375°F.

1 In standby mode, rotate the FUNCTION knob to choose Bake program.



FUNCTION

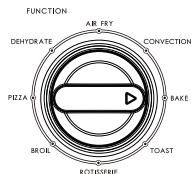

2 Rotate the TEMP Knob to choose 375°F.



TEMP

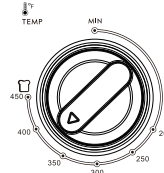

3 Rotate the TIME knob to choose 40 minutes



TIME

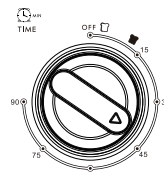

OPERATION INSTRUCTIONS

Rotiss



Accessory Guide:



For Rotisserie function, suggested cooking temperature can be selected between 200°F and 450°F. The suggested longest cooking time is 90 minutes.

Example: Use Rotisserie function to cook for 40 minutes at 325°F.

- 1 In standby mode, rotate the FUNCTION knob to choose Rotiss program.



FUNCTION

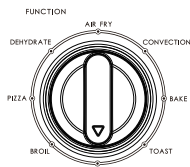

- 2 Rotate the TEMP knob to choose 325°F.



TEMP

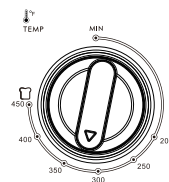

- 3 Rotate the TIME knob to choose 40 minutes



TIME

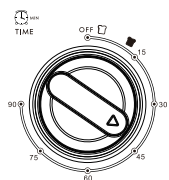

OPERATION INSTRUCTIONS

Broil



Accessory Guide:

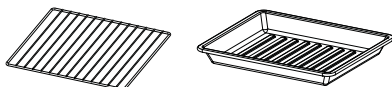

For Broil function, The suggested temperature is 450°F. The longest cooking time is 90 minutes.

Example: Use Broil function to cook for 40 minutes.

- 1 In standby mode, rotate the **FUNCTION** knob to choose Broil program.



FUNCTION

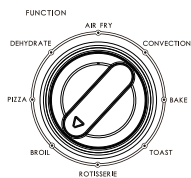

- 2 Rotate the **TEMP** knob to choose 450°F.



TEMP

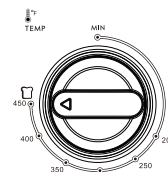

- 3 Rotate the **TIME** knob to choose 40 minutes



MIN
TIME

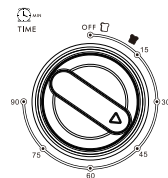

OPERATION INSTRUCTIONS

Pizza



Accessory Guide:



For Pizza function, suggested cooking temperature can be selected between 200°F and 450°F. The suggested longest cooking time is 90 minutes,

Example: Use Pizza function to cook for 40 minutes at 375°F.

1 In standby mode, rotate the FUNCTION knob to choose Pizza program.



FUNCTION

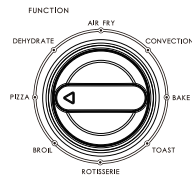

2 Rotate the TEMP knob to choose 375°F.



TEMP

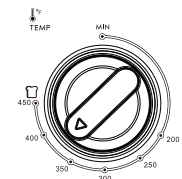

3 Rotate the TIME knob to choose 40 minutes



TIME

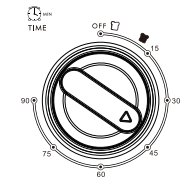

OPERATION INSTRUCTIONS

Conv



Accessory Guide:



For Convection function, cooking temperature can be selected between 200°F and 450°F. The longest cooking time is 90 minutes.

Example: Use Convection function to cook for 40 minutes at 375°F.

- 1** In standby mode, rotate the **FUNCTION** knob to choose Conv program.



FUNCTION

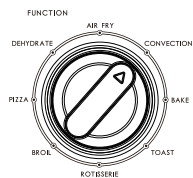

- 2** Rotate the **TEMP** knob to choose 375°F.



TEMP

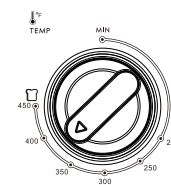

- 3** Rotate the **TIME** knob to choose 40 minutes



TIME

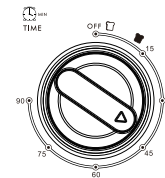

PRODUCT WARRANTY

This warranty applies to products sold by Galanz Americas in the U.S. This warranty is in lieu of any other warranty and expressly applies to the individual product only.

Galanz product is warranted for one year following purchase for defects in material and workmanship. Please save your receipt as proof of purchase is required to make a warranty claim. During this warranty period, we will provide the replacement cost of this product or the equivalent or repair per our discretion.

The warranty cannot be transferred through resale, including the resale through a 3rd party unauthorized retailer and is only bestowed upon the original consumer purchaser upon purchase from an authorized retailer.

■ **This warranty does not cover and excludes damage or defects caused by:**

- Consumer misuse
- Abuse
- Neglect including the failure to clean and/or provide adequate regular maintenance as outlined in the user manual
- Commercial use
- Subjecting the product to any voltage outside the specified range
- Loss of parts
- The affixing of any attachments not provided with the product
- Accident, or
- Use in a manner not intended and outlined in the user manual.
- Any subsequent damages caused by the above listed exclusions will not be covered and any claims determined to meet the above exclusions will be denied. All liability is limited to the

- purchase price and does not include any:
- Retail offered extended warranties
- Tax
- Other charges (including postage to send required materials) incidental and/or consequential damages associated with the product in question.

Every implied warranty, including any statutory warranty of merchantability or fitness for a particular purpose is disclaimed except to the extent prohibited by law, in which case such warranty is limited to the duration of this written warranty. This warranty gives you specific legal rights. You may have other legal rights that vary depending on where you live. Some states do not allow limitations on implied warranties or special, incidental, or consequential damaged, so the above limitations may not apply to you.

If you have a claim under this warranty, please call our Customer Service number: 1-800-562-0738.

For faster service, please have the model number, serial number, and receipt ready for the operator to assist you.

WARRANTY REGISTRATION

Please mail this warranty card to address below within 30 days of purchase.

Galanz Americas, 55 Challenger Road, Suite 503, Ridgefield Park, NJ 07660.

PLEASE PRINT CLEARLY.

Name _____

Address _____

City _____ State _____ Zip _____

Phone _____ Email _____

Model Number _____ Serial Number _____

Purchase Location _____

You must attach a copy of your purchase receipt to validate your registration.

Galanz