

HARDWARE IDENTIFIER

Illustrations on this page are to scale for faster identification of hardware during assembly.

DO NOT RETURN PRODUCT IF YOU ARE MISSING PARTS.

Please Call: 1 (877) 728-8224



Exterior circumferences of washers can vary.

These dimensions are a measurement of the internal diameter of the washer.

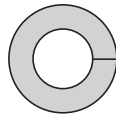

10

Washer; Lock, 5/16" (x10)

40M1000P

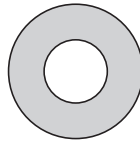

11

Washer; Flat, 5/16" (x6)

45M1111P

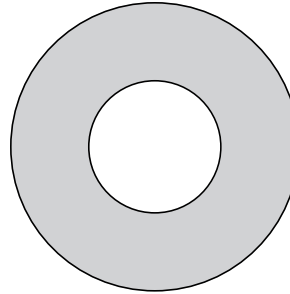

12

Washer; Flat, 5/8" (x8)

45M2121P

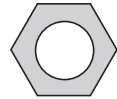

9

Nut; Hex 5/16"-18 (x10)

30M1000P

7

Screw: Round Head, 5/16"-18 x 3/4" (x6)

20M1012P

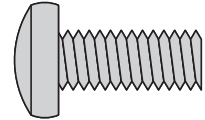

8

Screw: Round Head, 5/16 x 1" (x4)

20M1016P

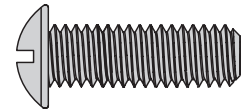

13

Hitch Pin; Drawbar, 1/2" x 2 1/2" (x1)

B-3861

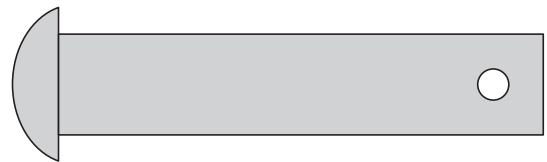

14

Square Bearing (x2)

B-6270

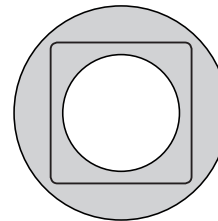

15

Hairpin Cotter, 1/8" (x3)

D-146P

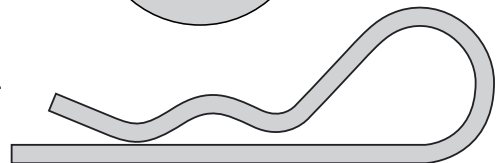

PARTS

Detail 1

Detail 2

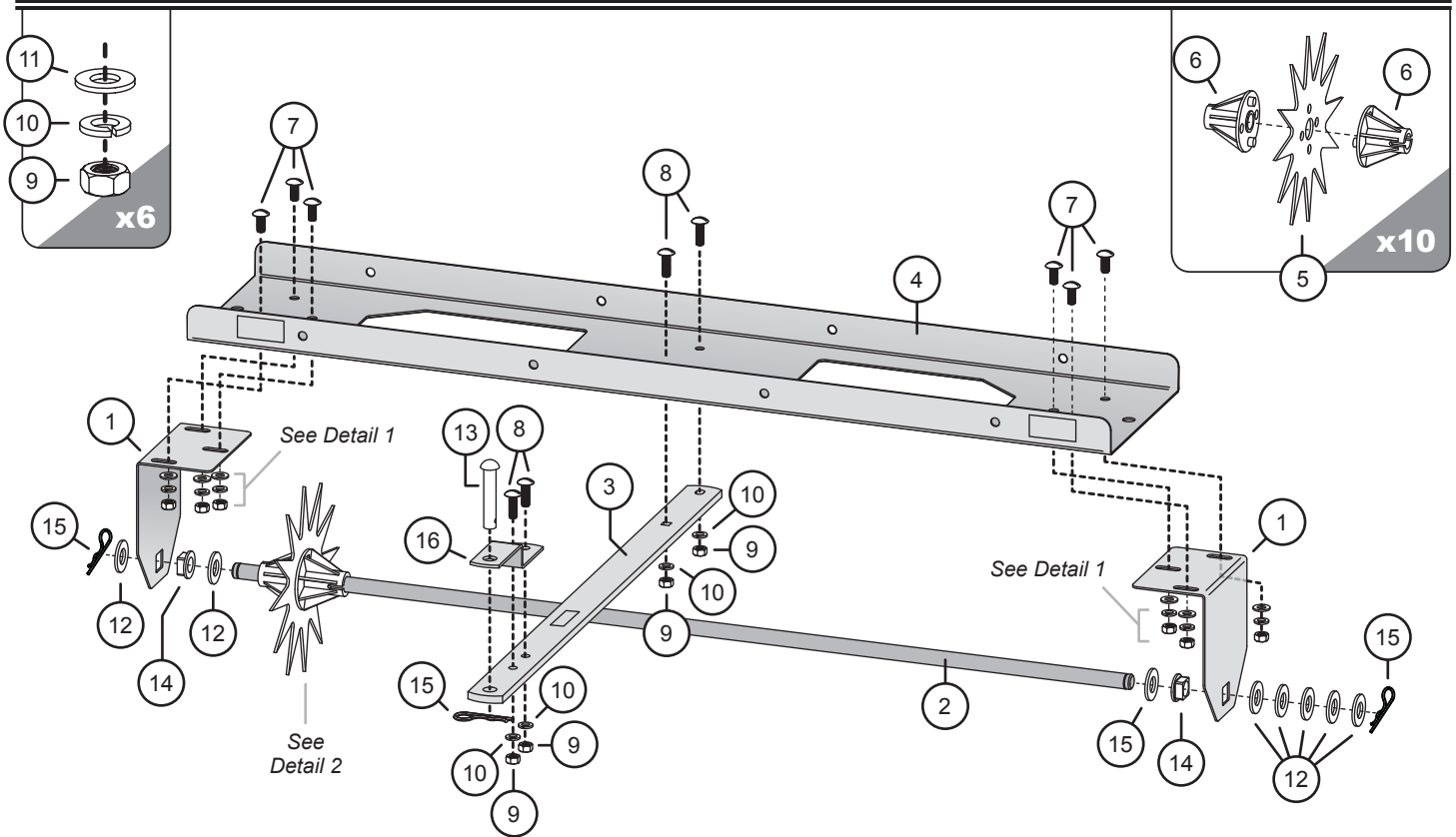

PART #s (vary by model)

Ref.	Description	Qty.	SA-401BH	SA-401BH-A
1	End Panel	2	1008490-10	1008490-10
2	Tine Shaft	1	1019939	1019939
3	Drawbar, w/ Decals	1	B-3593-1	1020062 **
4	Tray, w/ Decals	1	1008589	1020080
5	Tine	10	1018833-SER *	1018833-SER *
6	Bearing	20	B-5425	B-5425

1020063	Hardware Bag	1
7	20M1012P Screw; Round Head 5/16"-18 x 3/4"	6
8	20M1016P Screw; Round Head 5/16" x 1"	4
9	30M1000P Nut; Hex, 5/16"-18	10
10	40M1000P Washer; Lock, 5/16"	10
11	45M1111P Washer; Flat, 5/16"	6
12	45M2121P Washer; Flat, 5/8"	8
13	B-3861 Pin; Hitch, 1/2" x 2-1/2"	1
14	B-6270 Bearing; Square	2
15	D-146P Cotter; Hairpin, 1/8", #211	3
16	R-821-10 DrawBar, Clevis	1

* Tines come in a multi-pack (1019235).
An extra tine may be included.

** The SA-401BH-A drawbar (3) has a slightly different appearance, illustrated here:

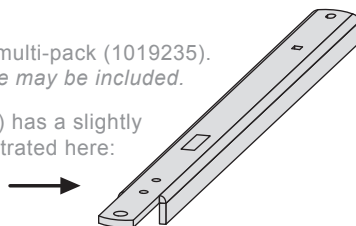

Installation Questions? Missing Parts? Replacement Parts?
DON'T GO BACK TO THE STORE!

Please call our Customer Service Department, Toll Free: 877-728-8224 or customerservice@brinly.com