

**Duro**  
NEXT GENERATION

**Max**  
POWER SYSTEMS



THE



**DUROMAXX**

customer\_service@maxtool.com  
or call 1-800-629-3325 (option 3) Monday - Friday 7am to 5pm. PST

**Product Support** (Product: information, application, and service info & warranty questions)





support@maxtool.com  
or call 1-800-629-3325 (option 4) Monday - Friday 7am to 5pm. PST

This manual provides information regarding the operation and maintenance of these products. We have made every effort to ensure the accuracy of the information in this manual. We reserve the right to change this product at any time without prior notice.

	<b>WARNING:</b>	
<p>The engine exhaust from this product contains chemicals known to the State of California to cause cancer, birth defects or other reproductive harm.</p>		

**WARNING:**

The generator is a potential source of electrical shock if misused. Do not expose the generator to moisture, rain or snow. Do not let the generator get wet, and do not operate it with wet hands.

 <b>WARNING</b>	
	<p><b>GASOLINE IS HIGHLY FLAMMABLE AND EXPLOSIVE. YOU COULD BE BURNED OR SERIOUSLY INJURED IF THE GASOLINE IS IGNITED.</b></p> <p>BEFORE REFUELLING, STOP THE ENGINE AND KEEP HEAT, SPARKS AND FLAME AWAY. HANDLE FUEL ONLY OUTDOORS. DO NOT FILL THE FUEL TANK ABOVE THE UPPER LIMIT LINE. WIPE UP SPILLS IMMEDIATELY.</p>
	<p><b>EXHAUST CONTAINS POISONOUS CARBON MONOXIDE GAS THAT CAN BUILD UP TO DANGEROUS LEVELS IN CLOSED AREAS.</b></p> <p><b>BREATHING CARBON MONOXIDE CAN CAUSE UNCONSCIOUSNESS OR DEATH.</b></p> <p>NEVER RUN THE GENERATOR IN A CLOSED, OR EVEN PARTLY CLOSED AREA WHERE PEOPLE MAY BE PRESENT.</p>
	<p><b>IMPROPER CONNECTIONS TO A BUILDING CAN ALLOW ELECTRICAL CURRENT TO BACK FEED INTO UTILITY LINES, CREATING AN ELECTROCUTION HAZARD.</b></p> <p>CONNECTIONS TO A BUILDING MUST ISOLATE GENERATOR POWER FROM UTILITY POWER AND COMPLY WITH ALL APPLICABLE LAWS AND ELECTRICAL CODES.</p>
	<p><b>THE GENERATOR IS A POTENTIAL SOURCE OF ELECTRICAL SHOCK IF NOT KEPT DRY.</b></p> <p>DO NOT EXPOSE THE GENERATOR TO MOISTURE, RAIN OR SNOW. DO NOT OPERATE THE GENERATOR WITH WET HANDS.</p>

These labels warn you of potential hazards that can cause serious injury. Read them carefully.

## SAFETY INFORMATION

Read and understand this instruction manual before operating your generator. You can help prevent accidents by being familiar with your generator's controls, and by observing safe operating procedures.

### Operator Responsibility

- ① Know how to stop the generator quickly in case of emergency.
- ① Understand the use of all generator controls, output receptacles, and connections.
- ① Do not let children operate the generator without parental supervision.

### Carbon Monoxide Hazards

- ① Exhaust contains poisonous carbon monoxide, a colorless and odorless gas. Breathing exhaust can cause loss of consciousness and may lead to death.
- ① If you run the generator in an area that is confined, or even partially enclosed, the air you breathe could contain a dangerous amount of exhaust gas. To keep exhaust gas from accumulating, provide adequate ventilation.

### Electric Shock Hazards

The generator produces enough electric power to cause a serious shock or electrocution if misused. Using a generator or electrical appliance in wet conditions, such as rain or snow, or near a pool or sprinkler system, or when your hands are wet, could result in electrocution. Keep the generator dry. If the generator is stored outdoors, unprotected from the weather, check all of the electrical components on the control panel, before each use. Moisture or ice can cause a malfunction or short circuit in electrical components, which could result in electrocution.

Do not connect to a building electrical system unless a qualified electrician has installed an isolation switch.

### Fire and Burn Hazards

- ① The exhaust system gets hot enough to ignite some materials.
  - Keep the generator at least 3 feet (1 meter) away from buildings and other equipment during operation.
  - Do not enclose the generator in any structure.
  - Keep flammable materials away from the generator.
- ① The muffler becomes very hot during operation and remains hot for a while after stopping the engine.
  - Be careful not to touch the muffler while it is hot. Let the engine cool before storing the generator indoors.
- ① Gasoline is extremely flammable and is explosive under certain conditions. Do not smoke or allow flames or sparks where the generator is refueled or where gasoline is stored. Refuel in a well-ventilated area with the engine stopped.
- ① Fuel vapors are extremely flammable and may ignite after the engine has started. Make sure that any spilled fuel has been wiped up before starting the generator.

## CONTENTS

<b>SAFETY INFORMATION.....</b>	<b>2</b>
<b>COMPONENT IDENTIFICATION.....</b>	<b>4</b>
<b>WATTAGE REFERENCE CHART.....</b>	<b>7</b>
<b>SPECIFICATIONS.....</b>	<b>8</b>
<b>WIRING DIAGRAM.....</b>	<b>9</b>
<b>ASSEMBLY.....</b>	<b>10</b>
<b>PRE-OPERATION CHECK.....</b>	<b>10</b>
<b>STARTING THE ENGINE/STOPPING THE ENGINE.....</b>	<b>12</b>
<b>OPERATING INSTRUCTIONS.....</b>	<b>12</b>
<b>MAINTENANCE.....</b>	<b>15</b>
<b>STORAGE.....</b>	<b>18</b>
<b>TROUBLESHOOTING.....</b>	<b>19</b>
<b>WARRANTY SERVICE INFORMATION.....</b>	<b>24</b>

## COMPONENT IDENTIFICATION

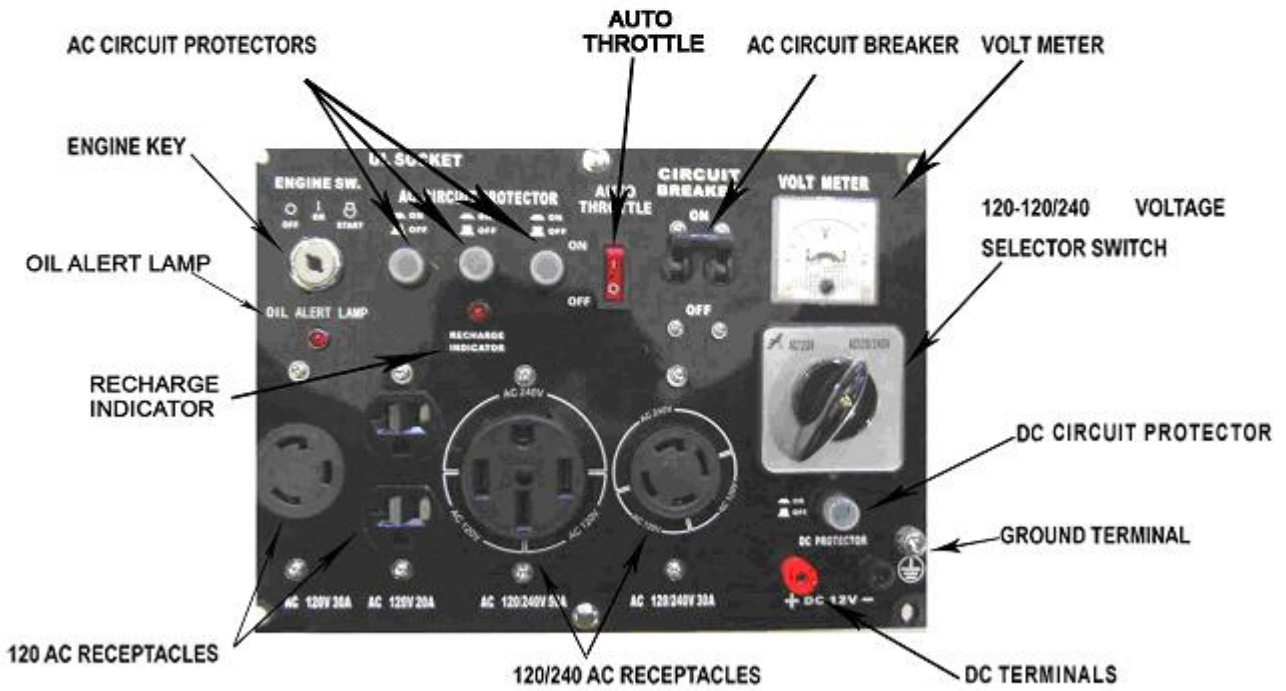

## Engine Key

To start and stop the engine.

### Key position:

**OFF:** To stop the engine. Key can be removed / inserted.

**ON:** To run the engine after starting, or to pull start the unit.

**START:** To start the engine by operating the starter motor.



### **WARNING:**

Do not turn the key switch to START position when the engine is running to prevent damage to the starting motor.

## Recoil Starter

To start the engine, turn the key to on, pull the starter grip lightly until resistance is felt, then pull briskly.

### **WARNING:**

Do not allow the starter grip to snap back against the engine. Return it gently to prevent damage to the starter.

## Fuel Valve Lever

The fuel valve is located between the fuel tank and carburetor. When the valve lever is in the ON position, fuel is allowed to flow from the fuel tank to the carburetor. Be sure to return the fuel valve lever to the OFF position after stopping the engine.

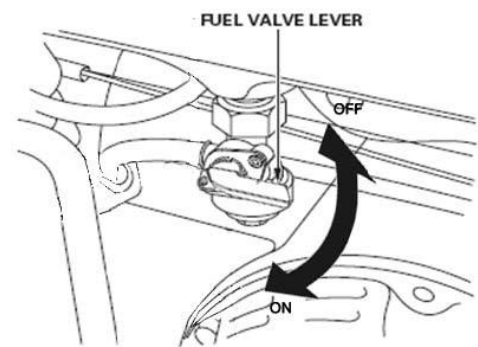

## Choke Rod

The choke is used to provide an enriched fuel mixture when starting a cold engine. It can be opened and closed by operating the choke rod manually. Pull the rod out toward CLOSED to enrich the mixture for cold starting

## Voltage Selector Switch

The voltage selector switch switches the main power carrying windings of the generator to produce "120V" or "120/240V". If a 240V appliance is connected to the 4-prong receptacles, the switch must be in the "120/240V" position. If only a 120V appliance is being connected select the "120V" position.

### Switch Position

**120/240V:** The 120V and 120/240V receptacles can be used simultaneously.

**120V:** Do not use the 120/240V twist lock receptacle in this position. The most power will be available at the 50A 120/240V receptacle.

**WARNING:**

Change the Voltage Selector Switch after turning the AC circuit breaker to OFF. The generator may be damaged if the Voltage Selector Switch is changed with the breaker in the ON position.

**Ground Terminal**

The generator ground terminal is connected to the frame of the generator, the metal non-current-carrying parts of the generator, and the ground terminals of each receptacle.

**DC Receptacle**

The DC receptacle may ONLY be used for charging 12 volt automotive type batteries. The battery must be connected to the generator DC receptacle with the proper polarity (battery positive to generator positive (+) and battery negative to the generator negative (-).

**WARNING:**

Do not start the vehicle while the battery charging cable is connected and the generator is running. The vehicle or the generator may be damaged.

**DC Circuit Protector**

The DC circuit protector automatically shuts off the DC battery charging circuit when the DC charging circuit is overloaded, when there is a problem with the battery, or when the connections between the battery and the generator are improper.

**Oil Alert System**

The Oil Alert system is designed to prevent engine damage caused by an insufficient amount of oil in the crankcase. Before the oil level in the crankcase can fall below a safe limit, the Oil Alert system will automatically stop the engine (the engine switch will remain in the ON position). The Oil Alert system should not take the place of checking the oil level before each use.

If the engine stops and will not restart, check the engine oil level before troubleshooting in other areas.

**AC Circuit Breaker**

The AC circuit breaker will automatically switch OFF if there is a short circuit or a significant overload of the generator at the receptacle. If the AC circuit breaker is switched OFF automatically, check that the appliance is working properly and does not exceed the rated load capacity of the circuit before switching the AC circuit breaker ON again. The AC circuit breaker may be used to switch the generator power ON or OFF.

**AC Circuit Protector**

The AC circuit protectors will automatically switch OFF if there is a short circuit or a significant overload of the generator at the 20A 120V, 30A 120V plug. If an AC circuit protector switches OFF automatically, check that the appliance is working properly and does not exceed the rated load capacity of the circuit before resetting the AC circuit protector ON.



## WATTAGE REFERENCE CHART

Electric equipment, especially engines produce strong current when being started. The table below offers references when you connect those installations to generator.

Tool or Appliance	Rated* (Running) Watts	Additional Surge (Starting) Watts
<b>Essentials</b>		
Light Bulb-75 watt	75	-
Deep Freezer	500	800
Sump Pump	800	1200
Refrigerator/Freezer-18 Cu. Ft.	800	1600
Water Well Pump-1/3 HP	1000	2000
<b>Heating/Cooling</b>		
Window Air Conditioner-12000 BTU	1200	1800
Window Fan	300	600
Furnace Fan Blower-1/2 HP	800	1300
<b>Kitchen</b>		
Microwave Oven-1000 watt	1000	2000
Coffee Maker	1500	-
Electric Stove- Single Element	1500	-
Hot Plate	2500	-
<b>Family Room</b>		
DVD/CD Player	100	-
VCR	100	-
Stereo Receiver	450	-
Color Television- 27"	500	-
Personal Computer w/17" Monitor	800	-
<b>Other</b>		
Security System	180	-
AM/FM Clock Radio	300	-
Garage Door Opener- 1/2 HP	480	520
Electric Water Heater- 40 Gallon	4000	-
<b>DIY / Job Site</b>		
Quartz Halogen Work Light	1000	-
Airless Sprayer- 1/3 HP	600	1200
Reciprocating Saw	960	960
Electric Drill- 1/2 HP	1000	1000
Circular Saw- 7 1/4"	1500	1500
Miter Saw- 10"	1800	1800
Table Planer- 6"	1800	1800
Table Saw / Radial Arm Saw- 10"	2000	2000
Air Compressor- 1- 1/2 HP	2500	2500

\*Wattages listed are approximate only. Check tool or appliance for actual wattage.



# SPECIFICATIONS

Generator	Model	XP12000E		
	Frequency	60 HZ		
	Max. AC Output	12000 Watt		
	Rated AC Output	9500 Watt		
	Run Time	8 hour		
Engine	Model	XP18HPE		
	Type	Air Cooled, OHV, 4-Stroke		
	Displacement	457 cc		
	Output	9.5kw / 3600 rpm		
	Fuel	Unleaded Gasoline		
	Fuel Tank Capacity	8.3 Gallon		
	Decibel	<72 dBA		
	Oil Alert	Standard		
	Battery	12V 18A/hr.		
	Fuel Gauge	Standard		
	Air Cleaner	Standard		
	Silencer	Standard		
	Standard Features	Voltmeter	Standard	Receptacle 2×NEMA 5-20R 1×NEMA 5-30R 1×NEMA L14-30R 1×NEMA 14-50R  Plug(Not included with your generator)
		Voltage Selector	Standard	
DC Circuit Breaker		Standard		
DC Receptacle		Standard		
AC Circuit Breaker		Standard		
AC Circuit Protector		Standard		
AC Receptacle		2 Pole 120V AC 3 Pole 120V/240V AC		
Dimensions	Length	34"	2×NEMA 5-20P	
	Width	27"	1×NEMA 5-30P	
	Height	32"	1×NEMA L14-30P	
	Gross Weight	240 lbs.	1×NEMA 14-50P	

# ASSEMBLY

## Wheel Kit Installation

- 1 Install the axle assembly on the generator.
- 2 Install the two wheels on the axle shaft using the flange nuts.
- 3 Install the two stands on the under frame using the flange nuts.

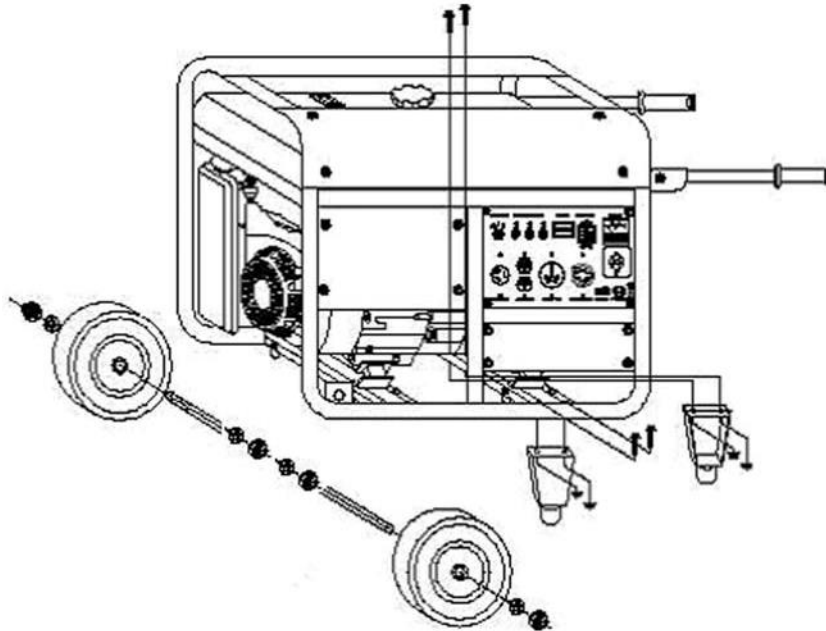

## Starter Cables Connection

- 1 Route the starter cable under the tank.
- 2 Connect the starter cable to the battery positive (+) terminal first, then to the negative (-) terminal. When disconnecting, disconnect at the battery negative (-) terminal first.

### **WARNING:**

Battery posts, terminals and related accessories contain lead and lead compounds. Wash hands after handling.

## PRE-OPERATION CHECK

### Engine Oil

#### **WARNING:**

Engine oil is a major factor affecting engine performance and service life. Non-detergent and 2-stroke engine oils will damage the engine and are not recommended.

- ① Check the oil level BEFORE EACH USE with the generator on a level surface and the engine stopped.
- ② Use 4-stroke motor oil that meets or exceeds the requirements for API service classification SJ.

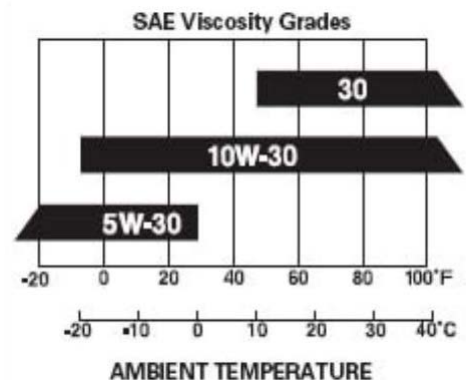

Always check the API SERVICE label on the oil container to be sure it includes the letter SJ.

- ① SAE 10W-30 is recommended for general, all-temperature use. Other viscosities shown in the chart may be used when the average temperature in your area is within the indicated range.

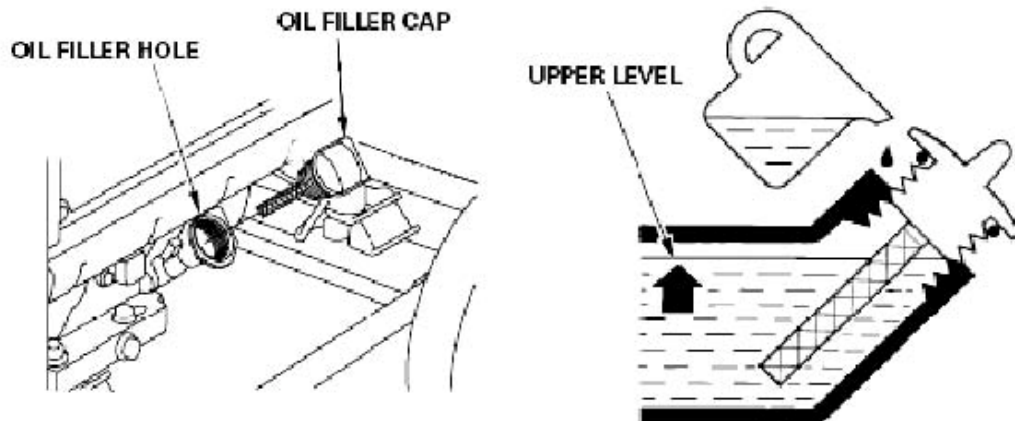

- 1 Remove the oil filler cap and wipe the dipstick clean.
- 2 Check the oil level by inserting the dipstick into the filler neck without screwing it in.
- 3 If the level is low, fill to the top of the oil filler neck with the recommended oil.

## Fuel

- ① Check the fuel gauge, and refill the tank if the fuel level is low.
- ① Refuel carefully to avoid spilling fuel. Do not fill above the shoulder of the fuel strainer.

### **WARNING:**

Gasoline is highly flammable and explosive, and you can be burned or seriously injured when refueling.

- Stop engine and keep heat, sparks, and flame away.
- Refuel only outdoors.
- Wipe up spills immediately.
- ① Use unleaded gasoline with an octane rating of 86 or higher.
- ① This engine is certified to operate **ONLY** on unleaded gasoline.

Unleaded gasoline produces fewer engine and spark plug deposits and extends exhaust system life. Never use stale or contaminated gasoline or an oil/gasoline mixture. Avoid getting dirt or water in the fuel tank.

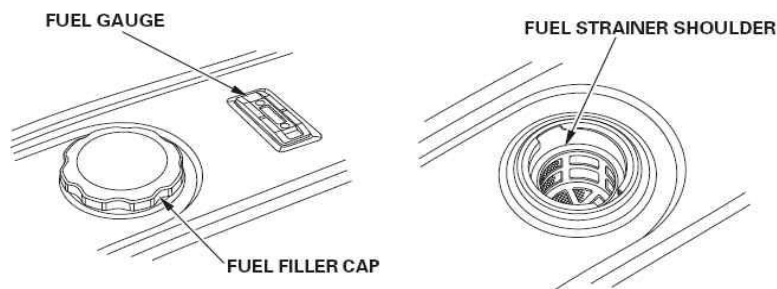

## Starting the Generator:

### **CAUTION:**

Disconnect all electrical loads from the generator before attempting to start!

1. Make sure that the AC circuit breaker is in the OFF position. The generator may be hard to start if a load is connected.
2. Turn the fuel valve lever to the ON position.
3. The choke will need to be closed, slide the choke lever out to the CLOSED position.
4. Turn the engine switch to the START position and hold it there for 5 seconds or until the engine starts.

### **WARNING:**

- Operating the starter motor for more than 5 seconds can damage the motor. If the engine fails to start, release the switch and wait 10 seconds before operating the starter again.
  - If the speed of the starter motor drops after a period of time, it is an indication that the battery should be recharged.
5. When the engine starts, allow the engine switch to return to the ON position.
  6. Push the choke to the OPEN position as the engine warms up.

## Stopping the Engine

### **In an emergency:**

 To stop the engine in an emergency, move the engine switch to the OFF position.

### **In normal use:**

1. Turn the AC circuit breaker to the OFF position. Disconnect any DC Load attached to the DC Output on the front panel.
2. Turn the engine switch to the OFF position.
3. Turn the fuel valve lever to the OFF position.

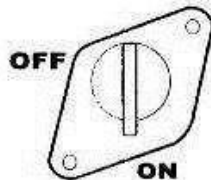

Figure 6 - fuel valve in the "on" position

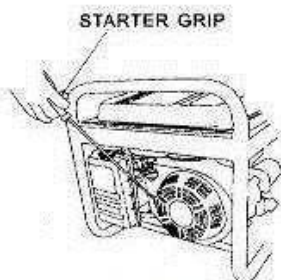

Figure 8 - Pulling the recoil start.



Figure 7 - Choke in the close position

# OPERATING INSTRUCTIONS

## Connections to a Building Electrical System

Connections for standby power to a building electrical system must be made by a qualified electrician. The connection must isolate the generator power from utility power, and must comply with all applicable laws and electrical codes. A transfer switch, which isolates generator power from utility power, is prerequisite.

### **WARNING:**

Improper connections to a building electrical system can allow electrical current from the generator to back feed into the utility lines. Such back feed may electrocute utility company workers or others who contact the lines during a power outage, and the generator may explode, burn, or cause fires when utility power is restored. Consult the utility company or a qualified electrician.

## Ground System

The portable generators have a system ground that connects generator frame components to the ground terminals in the AC output receptacles. The system ground is not connected to the AC neutral wire.

## AC Applications

Before connecting an appliance or power cord to the generator:

- Make sure that it is in good working order. Faulty appliances or power cords can create a potential for electrical shock.
- If an appliance begins to operate abnormally, becomes sluggish or stops suddenly, turn it off immediately. Disconnect the appliance, and determine whether the problem is the appliance, or if the rated load capacity of the generator has been exceeded.
- Make sure that the electrical rating of the tool or appliance does not exceed that of the generator.
- Never exceed the maximum power rating of the generator. Power levels between rated and maximum may be used for no more than 30 minutes.

### **WARNING:**

Substantial overloading will open the circuit breaker. Exceeding the time limit for maximum power operation or slightly overloading the generator may not switch the circuit breaker or circuit protector OFF, but will shorten the service life of the generator.

## AC Operation

- 1 Start the engine .
- 2 Turn the voltage selector switch to either position.

With the voltage selector switch in the “120/240V” position, you can use the 120V and 120/240V receptacles simultaneously. If you require more 120V only power, then select the "120V only" position, this will disable the 120/240V twist lock plug.

- 3 Switch the AC circuit breaker ON.
- 4 Plug in the appliance.

Most motorized appliances require more than their rated power for startup.

Do not exceed the current limit specified for any one receptacle. If an overloaded circuit causes the AC circuit breaker or AC circuit protector to switch OFF, reduce the electrical load on the circuit, wait a few minutes and then reset the AC circuit breaker or AC circuit protector.

## AC Receptacle Selection

The generator has two separate main power producing circuits. These two circuits supply equal power to different receptacles shown when the voltage selector switch is in the 120/240V position.

When two or more receptacles are used; prevent overloading by dividing the load between the two power circuits.

The chart below shows the rated load in amperes that can be connected to each receptacle to balance the generator.

The total rated ampere draw is 65A in 120V ONLY.

Main Power Circuit	Receptacles Powered by Each Main Circuit	Power Distribution
Main Circuit 1	2 and 5	2+5=39.6 A Rated
Main Circuit 2	1 and 4	1+4=39.6 A Rated

The table shows the specifications when the 120/240V locking plug receptacle is used for 120V.

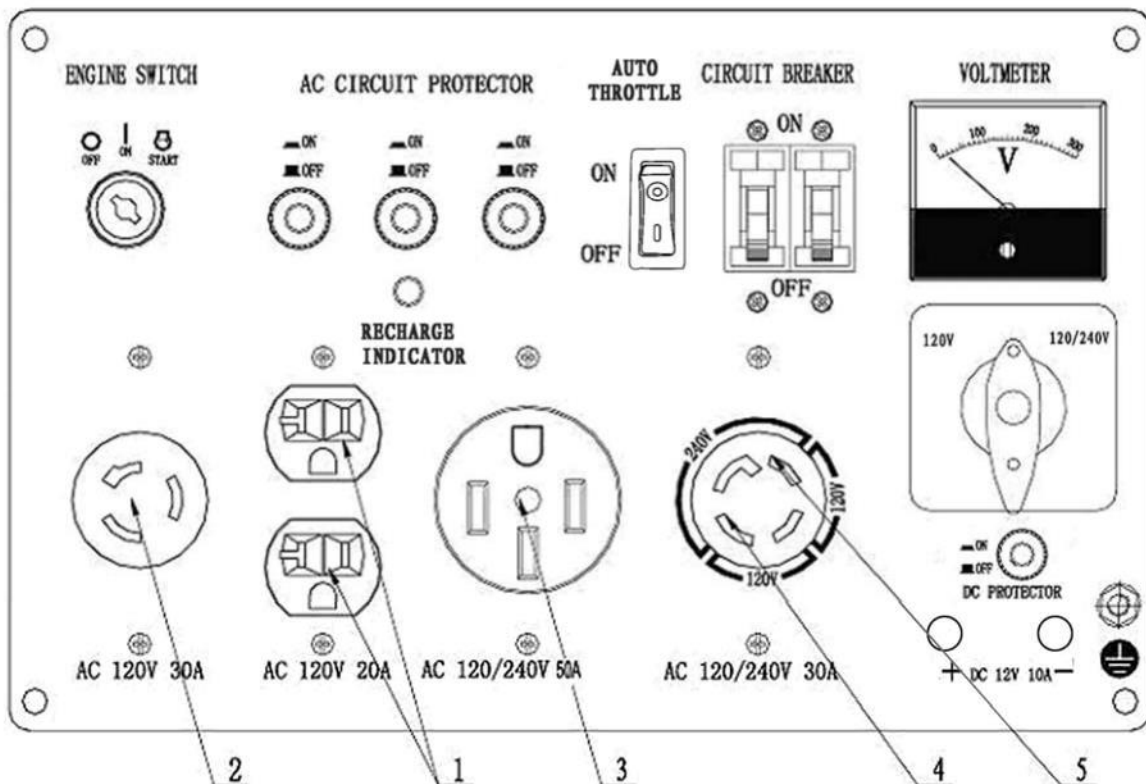

## DC Operation

The DC terminals may ONLY be used for charging 12 volt automotive type batteries.

### Connecting the battery cables:

- 1 Before connecting the battery charging cables to a battery that is installed in a vehicle, disconnect the vehicle ground battery cable from the battery negative ( - ) terminal.

### **WARNING:**

- ⓘ Batteries give off explosive gases; keep sparks, flames and cigarettes away. Provide adequate ventilation when charging or using batteries.
  - ⓘ Battery posts, terminals and related accessories contain lead and lead compounds. Wash hands after handling.
- 2 Connect the positive ( + ) battery cable to the battery positive ( + ) terminal.
  - 3 Connect the negative ( - ) battery cable to the battery negative ( - ) terminal.
  - 4 Connect the plug of the battery cable to the generator DC receptacle.
  - 5 Start the generator.

### **WARNING:**

Do not start the vehicle while the battery charging cable is connected and the generator is running. The vehicle or the generator may be damaged. An overloaded DC circuit, excessive current draw by the battery, or a wiring problem will trip the DC circuit protector. If this happens, wait a few minutes before pushing in the circuit protector to resume operation.

### Disconnecting the battery cables:

- 1 Stop the engine.
- 2 Disconnect the plug of the battery cable to the generator DC receptacle
- 3 Disconnect the other end of the negative ( - ) battery cable from the battery negative ( - ) terminal.
- 4 Disconnect the other end of the positive ( + ) battery cable from the battery positive ( + ) terminal.

- 5 Reconnect the vehicle ground battery cable to the battery negative ( - ) terminal.

### **High Altitude Operation**

At high altitude, the standard carburetor air/fuel mixture will be too rich. Performance will decrease, and fuel consumption will increase. A very rich mixture will also foul the spark plug and cause hard starting. Operation at an altitude that differs from that at which this engine was certified, for extended periods of time, may increase emissions. High altitude performance can be improved by specific modifications to the carburetor. If you always operate your generator at altitudes above 5,000 feet (1,500 meters), have a dealer perform this carburetor modification. This engine, when operated at high altitude with the carburetor modifications for high altitude use, will meet each emission standard throughout its useful life. Even with carburetor modification, engine horsepower will decrease about 3.5% for each 1,000-foot (300-meter) increase in altitude. The effect of altitude on horsepower will be greater than this if no carburetor modification is made.

#### **WARNING:**

When the carburetor has been modified for high altitude operation, the air/fuel mixture will be too lean for low altitude use. Operation at altitudes below 5,000 feet (1,500 meters) with a modified carburetor may cause the engine to overheat and result in serious engine damage.

## **MAINTENANCE**

The Importance of Maintenance.

Good maintenance is essential for safe, economical, and trouble-free operation. It will also help reduce air pollution.

#### **WARNING:**

Improper maintenance, or failure to correct a problem before operation, can cause a malfunction in which you can be seriously injured or killed.

Always follow the inspection and maintenance recommendations and schedules in this instruction manual.

### **Maintenance Safety**

- ⦿ Make sure the engine is off before you begin any maintenance or repairs.
- ⦿ Let the engine and exhaust system cool before touching.
- ⦿ To reduce the possibility of fire or explosion, be careful when working around gasoline. Use only a nonflammable solvent, not gasoline, to clean parts. Keep cigarettes, sparks, and flames away from all fuel-related parts.

### **Maintenance Schedule**

Remember that this schedule is based on the assumption that your machine will be used for its designed purpose. Sustained high-load or high-temperature operation, or use in unusually wet or dusty conditions, will require more frequent service.



REGULAR SERVICE PERIOD ( 2 )		Before each use	First month or 20 Hrs.	Every 3 months or 50 Hrs.	Every 6 months or 100 Hrs.	Every year or 300 Hrs.
ITEM Performed at every indicated month or operating hour interval, whichever comes first.						
● Engine oil	Check	○				
	Change		○		○	
● Air cleaner	Check	○				
	Clean			○ (1)		
● Sediment cup	Clean				○	
● Spark plug	Clean-Adjust				○	
	Replace					○
● Spark arrester	Clean				○	
● Idle speed	Check-Adjust					○
● Valve clearance	Check-Adjust					○
● Combustion chamber	Clean	After every 500 Hrs.				
● Fuel tank and filter	Clean				○	
● Fuel tube	Check	Every 2 years(replace if necessary)				

(1) Service more frequently when used in dusty areas.

(2) For commercial use, log hours of operation to determine proper maintenance intervals.

### Engine Oil Change

Drain the oil while the engine is warm to assure rapid and complete draining.

- 1 Remove the drain plug and sealing washer, remove the oil filler cap, and drain the oil.
- 2 Reinstall the drain plug and sealing washer. Tighten the plug securely.
- 3 Refill with the recommended oil and check the oil level.

Wash your hands with soap and water after handling used oil.

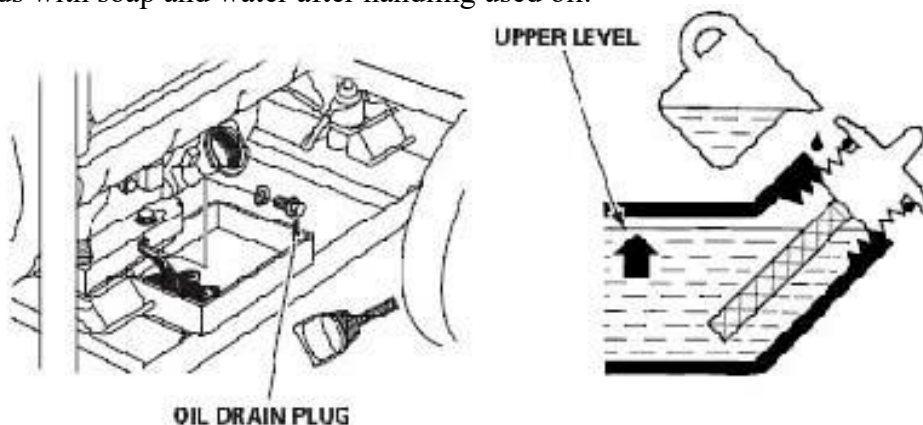

### Air Cleaner Service

A dirty air cleaner will restrict air flow to the carburetor. To prevent carburetor malfunction, service the air cleaner regularly. Service more frequently when operating the generator in extremely dusty areas.

## **WARNING:**

Never run the generator without the air filter. Rapid engine wear will result.

- 1 Unsnap the air cleaner cover clips, remove the air cleaner cover, and remove the element.
- 2 Wash the air cleaner element in a solution of household detergent and warm water, then rinse thoroughly, or wash in nonflammable or high flashpoint solvent. Allow the air cleaner element to dry thoroughly.
- 3 Soak the air cleaner element in clean engine oil and squeeze out the excess oil. The engine will smoke during initial startup if too much oil is left in the air cleaner element.
- 4 Reinstall the air cleaner element and the cover.

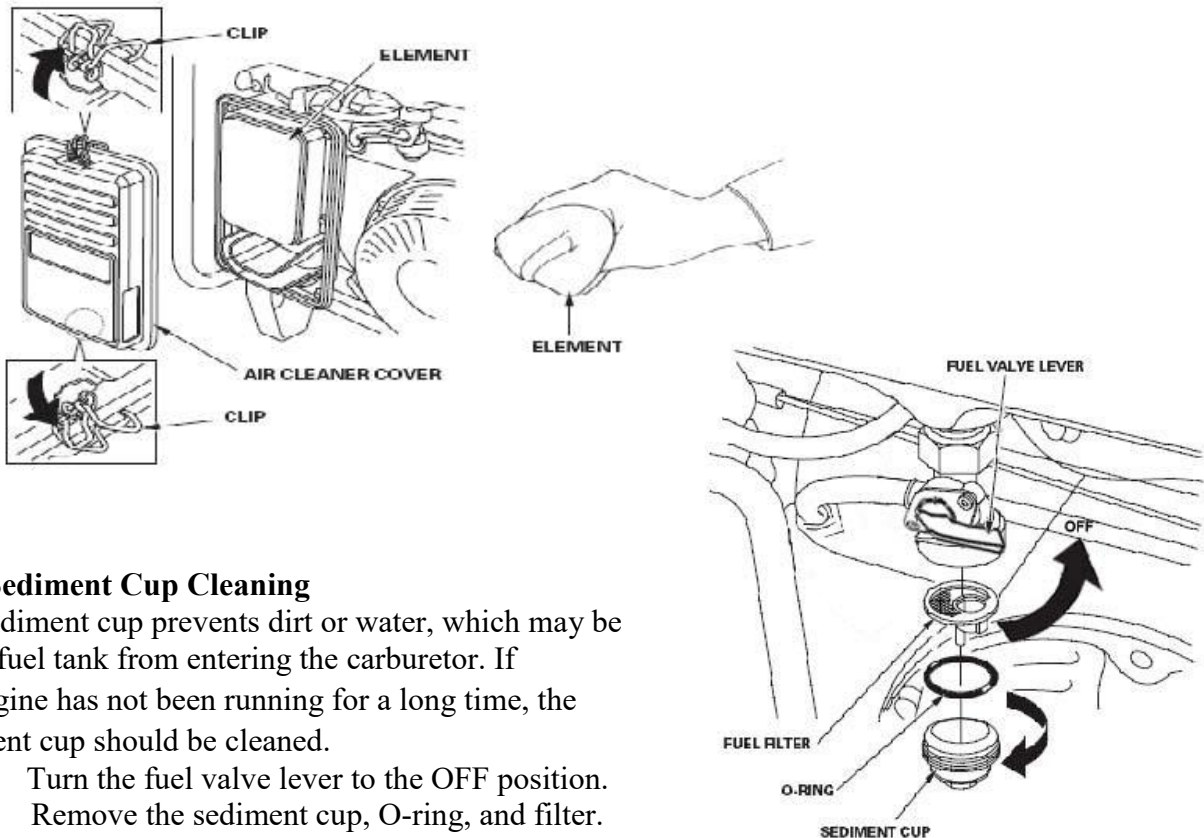

### **Fuel Sediment Cup Cleaning**

The sediment cup prevents dirt or water, which may be in the fuel tank from entering the carburetor. If the engine has not been running for a long time, the sediment cup should be cleaned.

- 1 Turn the fuel valve lever to the OFF position. Remove the sediment cup, O-ring, and filter.
- 2 Clean the sediment cup, O-ring, and filter in nonflammable or high flash point solvent.
- 3 Reinstall the filter, O-ring, and sediment cup.
- 4 Turn the fuel valve lever ON and check for leaks.

### **Spark Plug Service**

To ensure proper engine operation, the spark plug must be properly gapped and free of deposits.

If the engine has been running, the muffler will be very hot. Be careful not to touch the muffler.

- 1 Remove the spark plug cap.
- 2 Clean any dirt from around the spark plug base.
- 3 Use a spark plug wrench to remove the spark plug.
- 4 Visually inspect the spark plug. Discard it if the insulator is cracked, chipped or fouled.
- 5 Measure the plug gap with a feeler gauge. Correct as necessary by carefully bending the side electrode.

**The gap should be:** 0.028 0.031 in (0.70 0.80 mm)

- 6 Check that the spark plug washer is in good condition, and thread the spark plug in by hand to prevent cross-threading.
- 7 After the spark plug is seated, tighten with a spark plug wrench to compress the washer.

- If installing a new spark plug, tighten 1/2 turn after the spark plug seats to compress the washer. If reinstalling a used spark plug, tighten 1/8 - 1/4 turn after the spark plug seats to compress the washer.

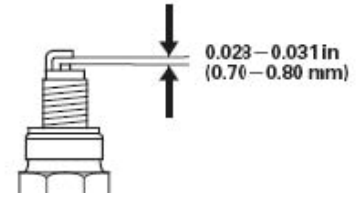

**WARNING:**

The spark plug must be securely tightened. An improperly tightened spark plug can become very hot and could damage the engine. Never use spark plugs which have an improper heat range.

**STORAGE**

Before storing the unit for an extended period:

- ⦿ Be sure the storage area is free of excessive humidity and dust.
- ⦿ Service according to the table below:

<b>STORAGE TIME</b>	<b>TO PREVENT HARD STARTING RECOMMENDED SERVICE PROCEDURE</b>
Less than 1 month	No preparation required
1 to 2 months	Fill with fresh gasoline and add gasoline conditioner.
2 months to 1 year	Fill with fresh gasoline and add gasoline conditioner. Drain the carburetor float bowl. Drain the fuel sediment cup.
1 year or more	Fill with fresh gasoline and add gasoline conditioner. Drain the carburetor float bowl. Drain the fuel sediment cup. Remove the spark plug and put a tablespoon of engine oil into the cylinder head. Pull recoil starter slowly to distribute the oil evenly in the cylinder. Reinstall the spark plug. Change the engine oil.  After removal from storage, drain the stored gasoline into a suitable container and fill with fresh gasoline before starting.

## TROUBLESHOOTING

**Note:** Troubleshooting problems may have similar causes and solutions.

<b>PROBLEM</b>	<b>POSSIBLE CAUSE</b>	<b>SOLUTION</b>
The engine will not start	Is there fuel in the tank?	Refill the fuel tank.
	Is there enough oil in the engine?	Add the recommended oil.
	Is the spark plug in good condition?	Readjust gap and dry the spark plug. Replace it if necessary.
	Is the fuel reaching the carburetor?	Clean the fuel sediment cup.
No electricity at the AC receptacles	Is the AC circuit breaker ON?	Turn the AC circuit breaker ON.
	Check the electrical appliance or equipment for any defects.	<ul style="list-style-type: none"> <li>- Replace the electrical appliance or equipment.</li> <li>- Take the electrical appliance or equipment to an electrical shop for repair.</li> </ul>

## GENERATOR ASSEMBLY AND MOUNTING

The Generator is supplied with a wheel kit. If you want to install the wheel kit on your unit, please follow the instructions below. If you not use the wheel kit, please skip this section.

1. Place the bottom of the generator on a flat, even surface. You may temporarily place the generator on blocks to ease assembly.
2. Attach the support leg to the cradle with bolts (M8x 16) and tighten nuts (M8) (see figure 1 ).
3. Attach the axles to the frame and tighten nuts (M12) (see figure 2).
4. Slide a wheel, hub to the inside, and a flat washer over the axle, then fix the wheel tightly with a retaining pin (see figure 3, Figure 4).
5. Place the handles on the cradle tightly with bolts (M8x16) and tighten nuts (M8) gently. Overtightening the handles will cause them to be very difficult to move. (Figure 5, Figure 6).
6. Make sure that all fasteners are tight and tight and tires are inflated between 15-40 PSI.

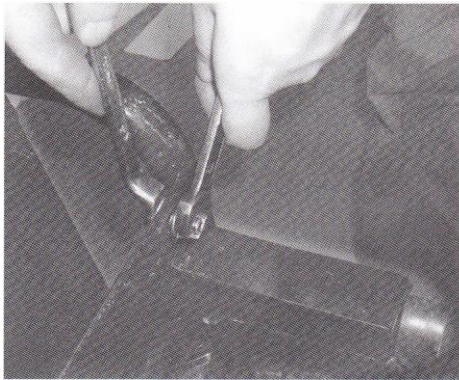

Figure 1



Figure 2

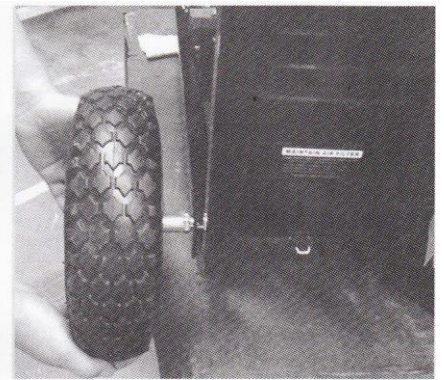

Figure 3

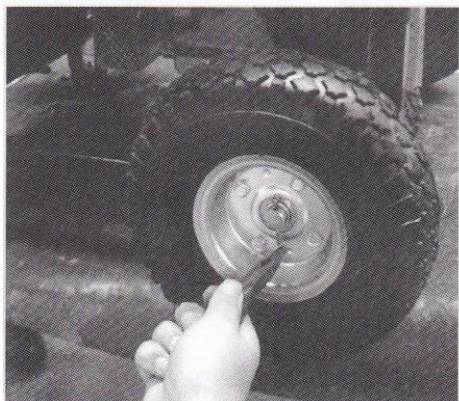

Figure 4

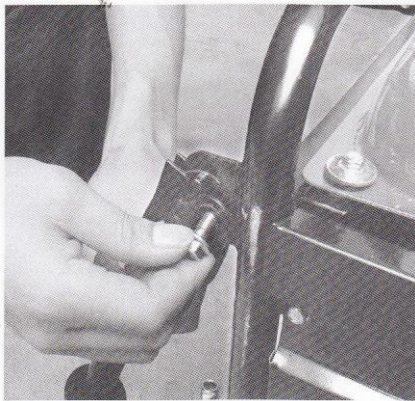

Figure 5

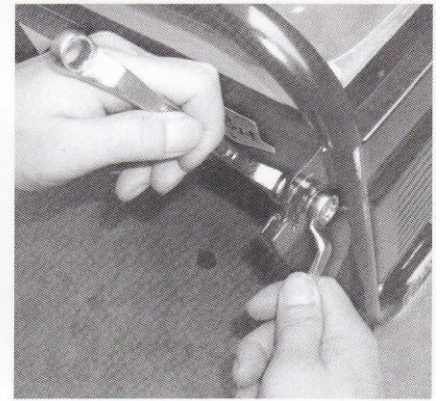
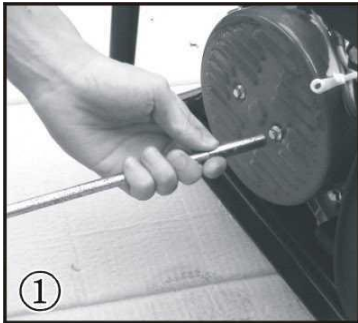

Figure 6

# CHANGE THE CARBON-BRUSH



①

Remove the 2 bolts (M5x12) on the generator back-cover

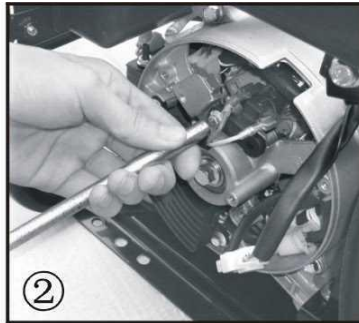

②

Remove the bolt (M5x16) holding the carbon brush.

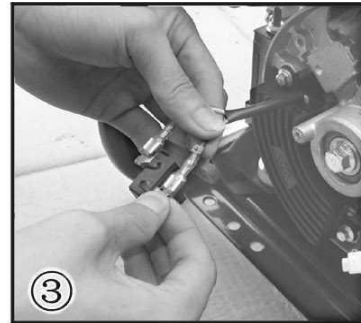

③

Remove the 2 wires from the AVR on the carbon brush.

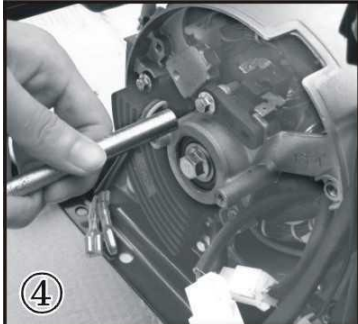

④

Install the new carbon brush with bolt (M5x16)

## CHANGE THE AVR

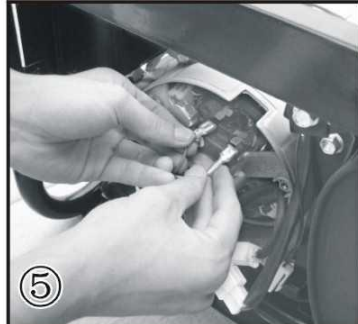

⑤

Insert and connect the 2 wires from the AVR, be sure to connect + and - correctly.

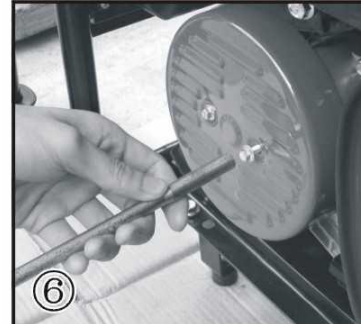

⑥

Replace the back cover of the generator and secure with the 2 bolts (M5x12)

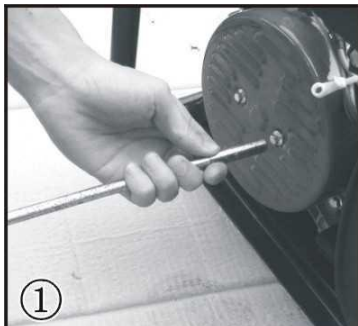

①

Remove the 2 bolts (M5x12) on the generator back cover.

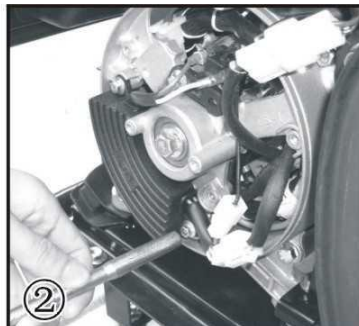

②

Remove the 2 bolts (M5x16) holding the AVR.

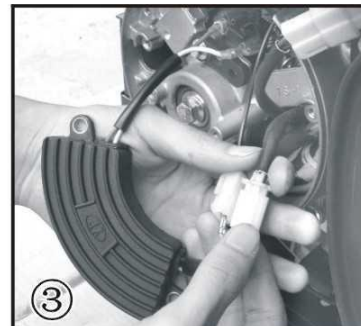

③

Disconnect the wire clip.



④

Remove the 2 wires of the AVR from the carbon brush.

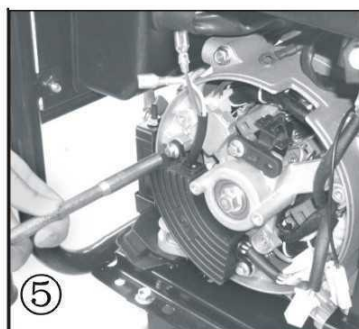

⑤

Install the new AVR with the 2 bolts (M5x16).

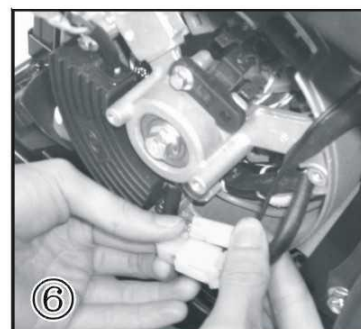

⑥

Reconnect the wire clip.



⑦

Connect the 2 wires to the carbon brush, be sure to connect the + and - correctly.

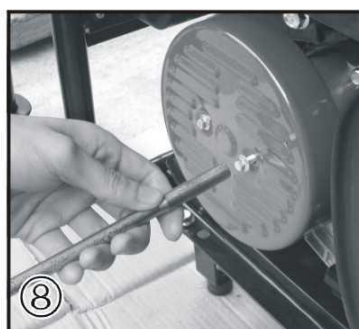

⑧

Replace the back cover of the generator and secure with the 2 bolts (M5x12).



**Duro**  
NEXT GENERATION

**Max**  
POWER SYSTEMS

**Rugged. Durable. Dependable. Power When You Need It!**



Recreation



Construction



Portable Power



Ice Storms



Hurricanes



Electrical Storms

**Product Support Product Information, Application, Service Info & Warranty Questions**

Please email us at [support@duromaxgenerators.com](mailto:support@duromaxgenerators.com)  
or call (800) 629-3325 Monday - Friday 7am to 5pm. PST