

Parts for Assembly:

A 1 pc. - Stand

B 2 pc. - Stand Handle

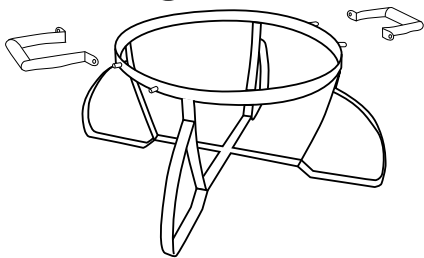

C 1 pc. - Kamado Grill



D 1 pc. - Fire Bowl

E 1 pc. - Top Vent



F 1 pc. - Charcoal Grate

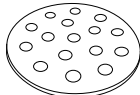

G 1 pc. - Cooking Grate

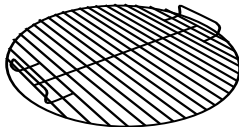

H 1 pc. - Ash Drawer

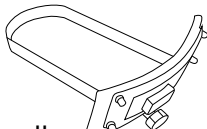

I 1 pc. - Wood Handle



Tools Included:

Wrench:
For handle assembly

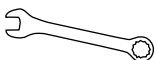

ENGLISH

VISION GRILLS™

SET UP

CADET SERIES

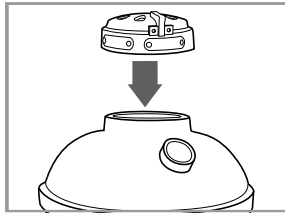

Step 1: Assemble Top Lid Vent

Close lid and press Top Vent onto top of Kamado. Be sure spring clips are fully engaged with calibrations facing the front of the grill.

Step 2: Stand Handle Assembly

Attach Stand Handles to the left and right of the Stand by placing handle brackets over stand studs.

On each stud use flat washers, then screw on acorn nuts and tighten with provided wrench.

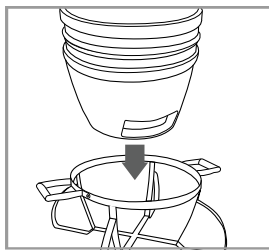
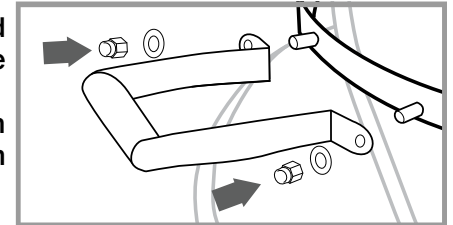

Step 3: Insert Grill into Stand

Take all parts out of the grill before lifting. With the help of a second person, lower the grill into the Stand by holding the back hinge and bottom of grill. As grill is lowered into stand, carefully switch out hands from bottom of grill to the ash drawer opening before reaching the outer ring of stand. Completely lower grill to bottom of stand.

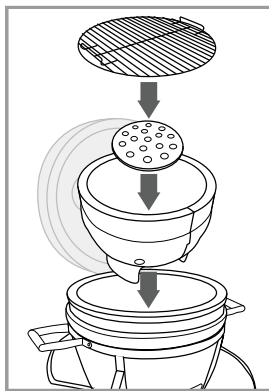

Step 4: Add Components to Grill

Lower fire bowl into the grill with the ash drawer opening facing the front of the grill. Place cast iron Charcoal Grate inside fire bowl. Place stainless steel cooking grate on top of the fire bowl.

Step 5: Grill Handle Assembly

Attach the Handle by placing handle bracket over studs, opposite the hinge. On each stud use flat washers, then screw on acorn nuts and tighten with provided wrench.

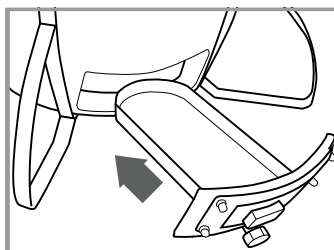
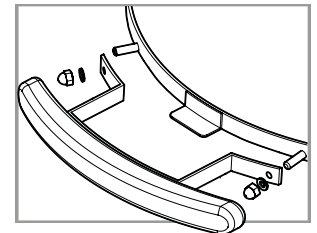

Step 6: Ash Drawer Usage

Slide Ash Drawer into ash drawer opening. When grill is cool, it is safe to remove ash from Ash Drawer. To remove Ash Drawer, use bottom knob on Ash Drawer, lift slightly and pull drawer out.

WARNING: ALWAYS WAIT FOR ASHES TO COOL BEFORE REMOVING ASH DRAWER. NEVER PULL OUT ASH DRAWER WHILE GRILL IS HOT.

PARTS

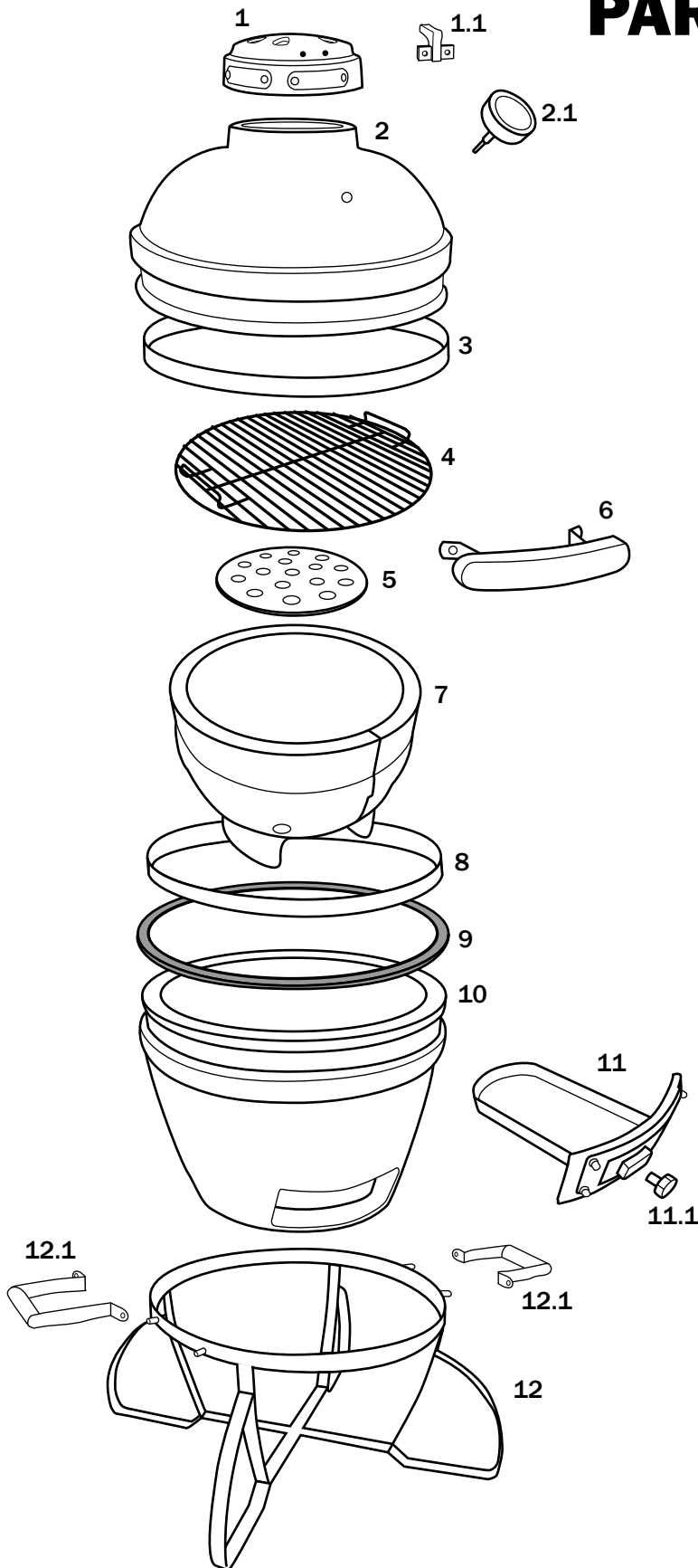

| PART NAMES | PART NUMBERS |
|---------------------------------|--------------|
| 1 Cast Iron Top Vent | VGC TV-VC |
| 1.1 Bakelite Tab | VGC TV-VC-K |
| 2 Ceramic Dome Lid | VGC CDL-VC |
| 2.1 Thermometer | VGC TMT-VC |
| 3 Top Ring Assembly | VGC RA1-VC |
| 4 Stainless Steel Cooking Grate | VGC CGD-VC |
| 5 Charcoal Grate | VGC CG-VC |
| 6 Handle (with nuts & washers) | VGC HDL-VC |
| 7 Fire Bowl | VGC FB-VC |
| 8 Bottom Ring Assembly | VGC RA2-VC |
| 9 Felt Gasket | VGC FLT-VC |
| 10 Ceramic Dome Bottom | VGC CDB-VC |
| 11 Ash Drawer Body | VGC ADB-VC |
| 11.1 Ash Drawer Knob | VGC ADB-VC-K |
| 12 Stainless Steel Stand | VGC SSS-VC |
| 12.1 Stand Handle (x 2) | VGC SSS-H-VC |

Visit www.visiongrills.com/register to register your grill.