

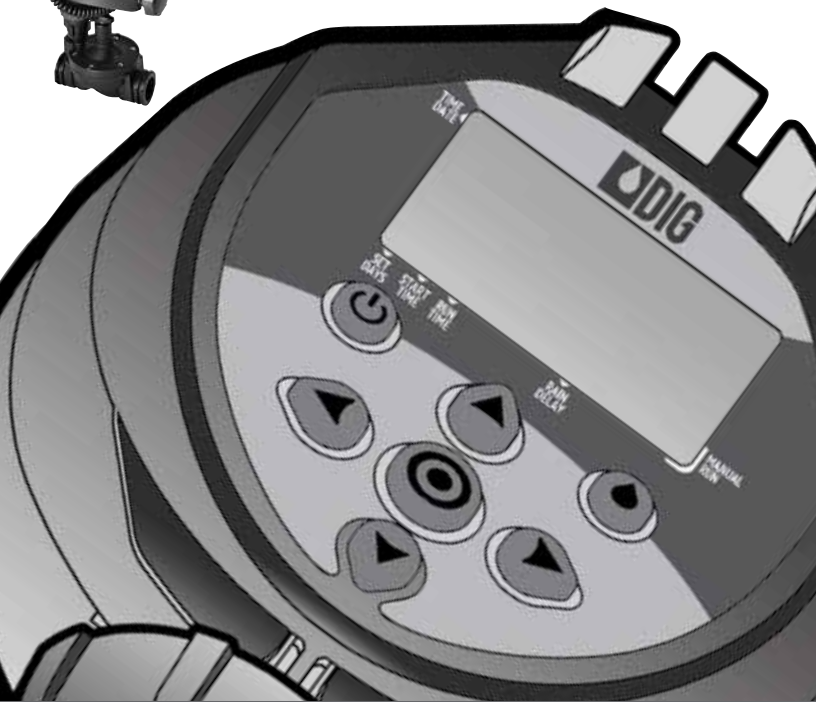

**Battery Powered  
In-line Valve  
with Watering Timer**

**RBC 7000**



**I N S T R U C T I O N M A N U A L**

## TABLE OF CONTENTS

1.	Introduction .....	1
2.	About the RBC 7000 battery timer .....	1
3.	Component identification .....	1
4.	LCD display and controls .....	2
5.	Installing the batteries .....	3
6.	Installation.....	4
7.	Programming.....	7
8.	Setting current time and date .....	7
9.	Setting watering day schedules .....	9
10.	Setting watering start times .....	12
11.	Setting watering run time duration .....	14
12.	Setting rain delay – optional feature .....	16
13.	Manual watering .....	17
14.	Connecting a rain sensor .....	18
15.	Changing the batteries .....	19
16.	Maintenance, troubleshooting and repairs .....	20
17.	Warranty .....	22
18.	Technical assistance .....	23
19.	To order replacement or spare parts .....	23

## 1. INTRODUCTION

Thank you for purchasing DIG's RBC 7000 Single Station Battery Operated Timer. This manual describes how to get the RBC series timer up and running quickly. After reading this manual and becoming familiar with the basic functionality of the timer, use the manual as a reference for less common tasks in the future.

## 2. ABOUT THE RBC 7000 BATTERY OPERATED TIMER

The RBC 7000 watering timer employs the latest irrigation programming features to allow for complete control of any irrigation system and can be installed on either an outdoor faucet or a PVC main water line. The RBC 7000 is available in single station with a rain sensor connection, and is powered by two AA batteries that can last up to 3 years [using name brand alkaline batteries]. The timer is enclosed in a compact, waterproof housing to protect it from the elements.

## 3. COMPONENT IDENTIFICATION

1. Timer cover
2. Quick reference label
3. LCD Display displays the icon-based applications/ programs
4. 7 button programming keypad: Use for programming, system on/off, manual run and reviewing program
5. Battery compartment cap for two AA alkaline batteries (not included)
6. Rain sensor yellow wire connection
7. Collapsible 36 in. solenoid wire
8. DC solenoid
9. Manual flow control
10. Solenoid Adapter
11. 3/4 in. professional grade in-line valve

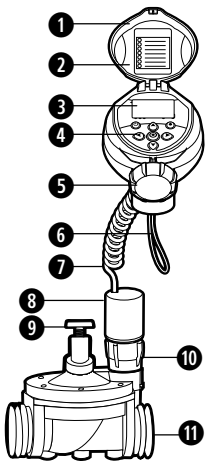



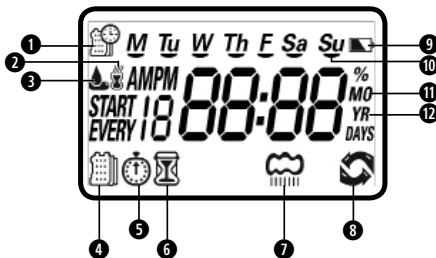



## 4. LCD DISPLAY AND CONTROLS



### LCD Display

1. **Time and Date Icon** – Indicates current time and day is displayed
2. **Sensor Icon** – Appears when a rain sensor is active or when yellow wire loop has been cut and watering is halted
3. **Watering Icon** – Appears when valve is open
4. **Set Watering Days Icon** – Choose either specific days, odd/even days, every X hours, or up to once every 30 days
5. **Start Time Icon** – Up to 4 start times per day available
6. **Run Time Icon** – Watering duration from 1 minute to 5 hours and 59 minutes
7. **Rain Delay Icon** – Delay irrigation setting from 1 to 99 days with automatic restart
8. **Manual Run Icon** – Appears when manual button is pushed
9. **Battery Level Indicator** – Flashes when batteries are low and need to be replaced
10. **Day of the Week Underscore** – Shows which day of the week the timer will operate
11. **Represents Month**
12. **Represents Year**

## Control Buttons

-  Select programming mode
-  Turn program(s) ON/OFF
-  Start/stop a manual cycle
-   Move left/right to select a value
-   Raise/lower the selected value

## 5. INSTALLING THE BATTERIES

1. Open the battery compartment cap by turning it counter-clockwise.
2. Install two, fresh, brand name, AA alkaline batteries (not included) and note the proper direction of the positive and negative orientation on the underside of the timer.
3. Insert and screw the battery cap clockwise. Make sure to securely tighten the cover firmly by hand only. The timer display appears with a day, PM, and the hour digit flashing. The timer is ready to be installed and programmed.

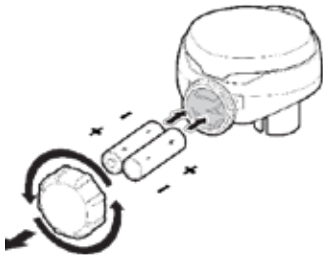

## 6. INSTALLATION

The RBC 7000 timer has a 3/4 in. inlet and outlet with female pipe thread so it can be installed directly onto 3/4 in. PVC male pipe thread fittings as part of a sprinkler valve manifold or as a stand-alone unit. (Figure 1)

OR

The RBC 7000 timer can be attached to a hose or faucet/spigot using the two adapters that are included with the timer. (Figure 7)

**Warning: Wrap all pipe thread fittings with Teflon tape. Do not use pipe dope/pipe cement on valve! This will damage the valve and void the warranty!**

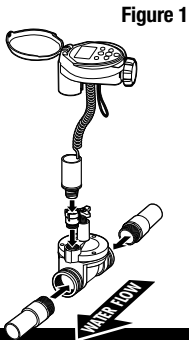

**ATTENTION: PLEASE NOTE THE DIRECTION OF THE VALVE WHEN INSTALLING. THE SOLENOID AND TIMER MOUNT IS POSITIONED TOWARDS THE OUTLET SIDE OF THE VALVE.**

### IN-LINE INSTALLATION

**Rated operating pressure: 10-125 PSI**

**Recommended Operating Pressure:  
10-80 PSI**

1. Shut off main water supply.
2. Install a 3/4 in. ball or gate valve onto the PVC pipe or to the valve manifold before installing the timer (Figure 2 and 3). This valve can be very useful as an emergency backup to turn the system off. This type of arrangement is used by professional installers.
3. Turn water supply on to flush the line and then shut the water off using the ball or gate valve.
4. Install the timer wrapping Teflon tape on all male pipe thread fittings.

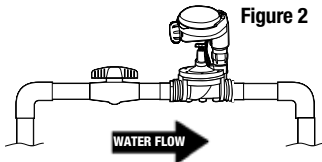
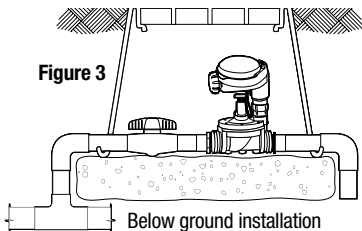

Figure 3



5. Turn water supply on to pressurize the system. The timer will open momentarily and then will shut off.
6. The unit is now ready to be programmed.

## FAUCET INSTALLATION

1. Wrap the swivel adapter and the nipple male pipe threads with 4-6 layers of Teflon tape in a clockwise direction.
2. Screw the swivel adapter male threads into the inlet side of the controller valve and tighten with a wrench or pliers. Repeat the steps with the  $\frac{3}{4}$ " MPT x MHT nipple. (see Figure 4).

Note: Do not apply any Teflon tape to the male hose thread faucet.

3. Make sure the washer is in place inside the female swivel adapter, and then screw the female swivel threaded clockwise onto the faucet and tighten by hand only. Do not use pliers or a wrench. (Figure 5)
4. Turn on the faucet and check for leaks.

***Warning: Do not tighten the swivel nut with pliers or wrench: Overtightening can cause damage to the swivel and washer resulting in leaks and/or disconnection from the faucet.***

### Basic installation of converting the controller with pipe thread into a hose thread

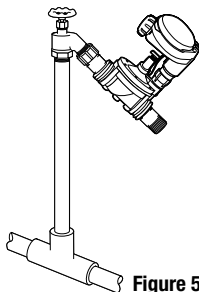
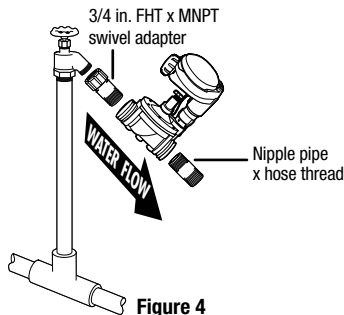

If a backflow preventer is part of the faucet (new houses) do not install any other backflow preventer to the faucet. If backflow preventers are part of your city code and you have purchased a unit as part of your drip system, install the device on the downstream side of the RBC 7000 (Figure 6 and 6a).

### Hose end drip system installation using a pressure regulator

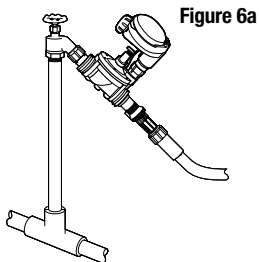
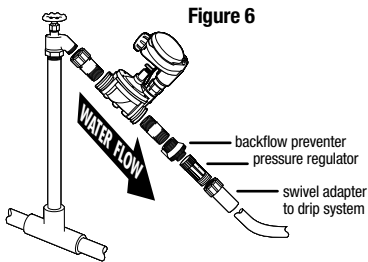

It is best to include a filter on a drip system. The filter cleans small particles out of the water that would otherwise clog the drippers. The filters can also automatically apply fertilizer through a drip system (Figure 7 and 8).



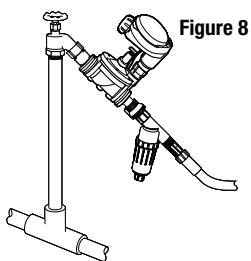
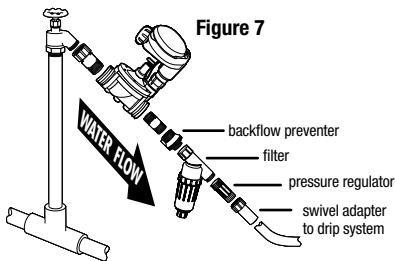

### Hose end drip system installation using a filter and a pressure regulator





## 7. PROGRAMMING

The RBC 7000 timer can be programmed to operate on any day of the week, odd days or even days. In cyclical mode the RBC can also operate from every 1 hour up to every 12 hours or from once a day up to every 30 days. The RBC has four start times per day and durations from 1 minute up to 5 hours and 59 minutes.

This section explains the programming features, and the steps necessary to assign irrigation schedules. To program the timer use the  to select the desired programming mode, the  to make the entry flash and the   buttons to change the value.

**NOTE:** Only a flashing value can be changed.

**NOTE:** If the last data entered stops flashing, press  again to resume programming and repeat the steps.

## 8. SETTING CURRENT TIME AND DATE

The timer can display the time in either a 12 or 24 hour format.

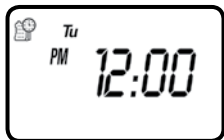

To change the time format, from the home screen:

1. Press the  button for three seconds until the  display switches format (AM/PM disappears).



### SETTING THE CURRENT TIME AND DATE

**To enable the timer to operate properly, the current time and date must be set.**

1. Press the  button, until the  icon appears along with the time and the day of the week.

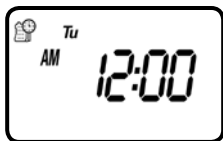

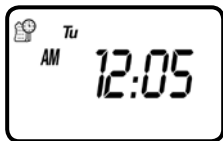

2. If the current time has not been set or needs to be updated press and the hour digit starts flashing.
3. To set the current hour, press or (note AM and PM designations).
4. To set the minutes, press again and the minute digit starts flashing. Press the or to set the current time in minutes.

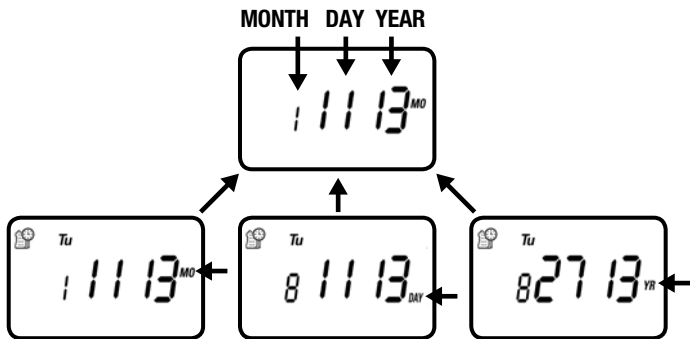

5. Repeat the steps to set the current date including, month, day and year. When the date is selected and updated, the day of the week will be update at the same time to correspond with the date.



Press  to proceed to the next step, SET DAYS  or to review the program.

Press  to move backward.

## 9. SETTING WATERING DAY SCHEDULES







### Option 1 – Setting Specific Days of the Week:

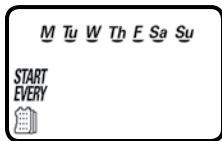

This setting determines which days the RBC 7000 timer will operate. Choose either watering on specific days of the week, EVEN/ODD days or cyclical from daily up to once every 30 days. The timer's default setting is to water on all specific days of the week.

For example, if you want to water every Tuesday, Thursday and Sunday:

1. Press the  button until the  icon and the days of the week appear on the screen.



2. Press  once and **M** (for Monday) starts flashing.
3. Press,  and underscore under **M** (Monday) disappears. Monday is de-selected.
4. Press  twice and **W** (for Wednesday) starts flashing.
5. Press  and the underscore under **W** (Wednesday) disappears. Wednesday is de-selected.
6. Press  twice and **F** (Friday) starts flashing.
7. Press  and the underscore under **F** (Friday) disappears. Friday is de-selected.



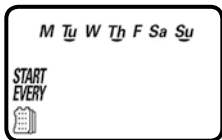

- Press  and the underscore under **Sa** (Saturday) starts flashing.
- Press  and the underscore under **Sa** disappears. Saturday is de-selected.



### Option 2 – Setting Even or Odd Days:

To select **EVEN** days, **ODD** days refer to the example.



Example: setting the timer to water on ODD days

- Press the  button until the  icon and the days of the week appear.
- Press  and  to skip all the days of the week (underscore must be removed beneath all days).
- Press  and **EVEN** appears flashing.



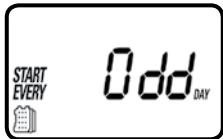





- Press  and **ODD** appears flashing





5. Press the  button to proceed to the next step START TIME  or to review the program.

### Option 3 – Setting every X hours:

Example: setting the timer to water every 7 hours

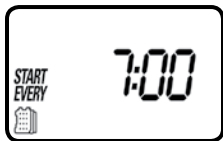







1. Press the  button until the  icon and the days of the week appear.
2. Press  and  to skip all the days of the week (underscore must be removed beneath all days).
3. Press  and EVEN appears flashing.
4. Press  again and 1:00 hour appears flashing. To select the number of hours between watering to 7 hours, press  until 7:00 appears on the display.



Press the  button to proceed to the next step START TIME  or to review the program.





#### Option 4 – Setting every X days:

Example: setting the timer to water every 10 days:

1. Press the  button until the  icon and the days of the week appear.
2. Press  and  to skip all the days of the week (underscore must be removed beneath all days).
3. Press  and EVEN appears flashing.
4. Press  again and 1 hour appears flashing.
5. Press  again and 1 DAY appears flashing. To select the number of days between watering to 10 days, press  until 10 appears on the display.



#### To set the timer back to specific days mode:

1. Push the  button until – *START EVERY* and the  icon appear at the bottom left of the screen.
  2. Push the  until the days of the week appear at the top of the screen.
- Press the  button to proceed to the next step *START TIME*  or to review the program.





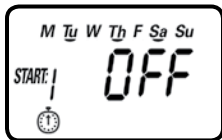

## 10. SETTING WATERING START TIMES

The RBC 7000 smart timer can have up to four separate irrigation start times per day. (Note: if the timer is set to water every X hours, only one start time is available to be programmed.)

To set a start time,

1. Press the  button until the  icon appears. START 1, displays OFF or the last start time programmed in START 1 appears.



2. Press  and OFF (or the first start time programmed) begins flashing.
3. To set the desired first start time hour (note AM and PM designations), press  or .
4. Press  and the minutes start flashing.
5. Press  or  and set the desired start time minutes.

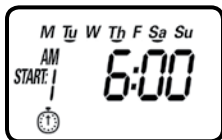

6. Press  again, the second start time and OFF or the last start time programmed appear flashing. Repeat the steps to set the second, third, and if needed, the fourth start time. During programming, if you are set to water on specific days of the week, the screen also shows which days the timer will operate with an underline.

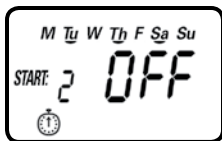

### To delete a start time:

1. Press until START 1 appears.
2. Press until the start time appears that you want to delete.
3. Press until the word OFF appears.

Press the button to proceed to the next step RUN TIME or to review the program.

## 11. SETTING WATERING RUN TIME DURATION

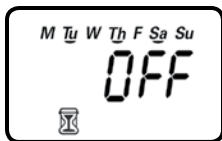

determines the length of time the RBC 7000 smart timer will allow the valve to remain open (duration is from 1 minute up to 5 hours and 59 minutes). For example, setting watering run time to 10 minutes on certain days of the week will program the timer to turn the water on for 10 minutes on each of the days chosen and at every start time selected. (Note: if the timer is set to water every X hours, the maximum duration is 59 minutes)

To set the watering run time :





1. Press the button until the icon appears and OFF or the last run time setting appears. (OFF will appear if duration is set to 0)
2. Press the button, and 0:05 (or the last run time programmed) appears.

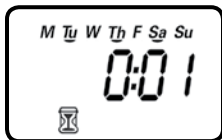

3. To set a desired watering run time in hours, press  or  and select the number of hours.



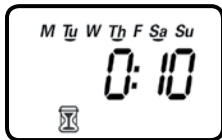

4. If only watering duration in minutes is required, press  to skip the hour digit, and the minutes will start flashing.

5. To set the desired watering duration in minutes (example of 10 minutes), press  or  to select minutes. When programming the watering duration, if you are set to water on specific days of the week, the screen will also show the days the timer will operate with an underline.





At this point the controller's normal programming is concluded.

Press the  button to proceed to the next step RAIN DELAY  or to review the program or to exit.

## 12. SETTING RAIN DELAY – OPTIONAL FEATURE



The Rain Delay setting is used to temporarily suspend all irrigation for a defined number of days. For example, during rainy weather regularly scheduled programs can be turned off from 1-99 days. At the end of the designated period, regularly scheduled programming will resume automatically.

To set a temporary suspension of the program:



1. Press the  button until the  icon and OFF appear.



2. Press the  button and OFF starts flashing.

3. To set the desired temporary suspension of the program (1-99 days), press  or .



4. The temporary suspension of the program can be cancelled at any time by re-entering Rain Delay screen and changing the setting to OFF. (Press  or  until OFF appears.)





**Note:** OFF appears in between numeric value of 99 and 1.

Press the  button to review the program or to exit.

### 13. MANUAL WATERING

The manual mode allows the user to test the system and water for a specified run time set in watering duration. The timer will automatically stop watering at the end of the defined irrigation period. The originally programmed irrigation schedule continues to function at the times assigned. The sensor condition is disregarded in this mode.

To start a manual run,

1. Press the  button, and the  icon and  icon appears. ON appears momentarily and then the last watering duration is displayed with  . The timer will open the valve and in 5 seconds a count down of the remaining irrigation duration appears, showing when the timer will close the valve.

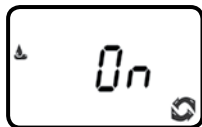

2. Press the  button to end manual run.
3. After 5 seconds the display will revert to the current time screen.

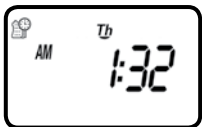

To activate a manual watering without the use of the timer – turn the solenoid a 1/4 turn counterclockwise. To stop, tighten the solenoid clockwise by hand only – do not over tighten (figure 9).

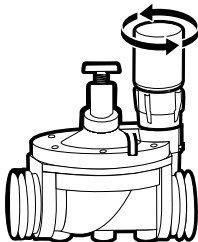

FIGURE 9

## 14. CONNECTING A RAIN SENSOR

Most “normally closed” rain sensors can be connected to the RBC 7000 timer. The function of the sensor is to prevent automatic watering by the set program due to excessive rainfall.

**To connect the sensor to the timer, please follow these steps:**

1. Cut the yellow wire loop that exits the timer in the middle of the loop.
2. Strip approximately 1/2 in. of insulation from the end of each wire.
3. Splice one yellow wire to each of the wires coming from the sensor.  
Use waterproof wire connectors to secure the connections.
4. When the sensor is active and preventing automatic operation, the 🕒 icon will appear on the display.



The  icon will only appear when sensor is active or if the wire has been cut.

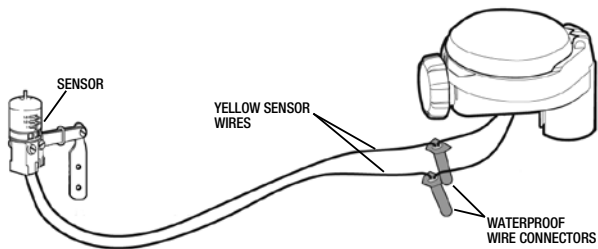

Recommended rain sensors are the Rain Bird RSD and Hunter Mini-Click

## 15. CHANGING THE BATTERIES

The RBC 7000 timer's batteries can last up to 3 years when using name-brand AA alkaline batteries. Actual battery life will depend on the sensitivity of the installed batteries to temperature ranges experienced by the timer as well as the number of valve operations programmed per day. To ensure proper operation, it is recommended that the RBC 7000 timer be checked regularly and the batteries replaced once the low battery indication starts flashing.



The RBC 7000 timer is designed to maintain the current time settings for up to 60 seconds with the batteries removed.

To change the batteries, see section 5.

**Note:** If the batteries are dead or drained, manual operation can also be accomplished by turning the solenoid counterclockwise, or by turning the external bleed screw counterclockwise. This will cause the valve to open. Both must be turned clockwise to close the valve.

## 16. MAINTENANCE, TROUBLESHOOTING AND REPAIRS

To restore the timer to the **default** settings

1. Press the  button until the **START EVERY** is displayed and the  icon appears on the bottom left of the screen.
2. Press and hold down the  for three seconds.
3. The screen returns to the home screen (clock) and all the default settings are restored. The current time and date is retained.

**PROBLEM:** Timer fails to open automatically or manually

**CAUSE:** No water pressure

**SOLUTION:** Open main water supply valve

**CAUSE:** Flow control knob is turned down

**SOLUTION:** Turn flow control knob clockwise to open

**PROBLEM:** Valve/actuator functions via the manual mode but not automatically

**CAUSE:** Timer is set to OFF mode

**SOLUTION:** Verify that the timer does not show OFF in current time mode

**CAUSE:** AM/PM not set correctly in current time mode

**SOLUTION:** Check current time, change AM/PM if necessary

**CAUSE:** AM/PM not set correctly in start time mode

**SOLUTION:** Check start time(s), change AM/PM if necessary

**CAUSE:** Rain delay is preventing watering

**SOLUTION:** Set rain delay to off

**CAUSE:** Yellow sensor wires have been cut

**SOLUTION:** Re-connect sensor wires together with waterproof connector

**CAUSE:** Sensor is installed and is in a state that prevents watering

**SOLUTION:** Check sensor and wire splices and verify sensor is normally closed

**PROBLEM:** The display is blank

**CAUSE:** No buttons have been pushed in the previous 15 minutes

**SOLUTION:** Push any button

**PROBLEM:** Valve fails to close

**CAUSE:** Solenoid is loose

**SOLUTION:** Tighten solenoid by turning it clockwise to the right

**CAUSE:** Valve is installed backwards

**SOLUTION:** Check flow arrow and verify arrows points away from water source – reverse valve if necessary

**CAUSE:** Debris is blocking solenoid port

**SOLUTION:** Shut off water supply, unscrew and remove solenoid, then open water supply and flush out solenoid port, re-install solenoid

**CAUSE:** Flow control knob is too far open

**SOLUTION:** Turn flow control knob clockwise and retest

**CAUSE:** Drip System flow rate is below minimum flow rate

**SOLUTION:** Increase system flow rate by adding or changing drippers

**PROBLEM:** Rain sensor does not prevent watering

**CAUSE:** Rain sensor is normally open, malfunctioning, or not wired correctly

**SOLUTION:** Verify that sensor icon appears on display when pin is pushed down and check all wire splices

**PROBLEM:** Timer waters more than once per day

**CAUSE:** More than one start time has been programmed

**SOLUTION:** Change start time 2, 3, and 4 to OFF

## 17. WARRANTY

DIG CORPORATION warrants these products to be free from defects in material and workmanship for a period of three years from date of purchase. This warranty does not cover damage resulting from accident, misuse, neglect, modification, improper installation or subjection to line pressure in excess of 125 lbs. per square inch for anti-siphon valves, in-line valves and for actuators. This warranty shall extend only to the original purchaser of the product for use by the purchaser.

The obligation of DIG CORPORATION under this warranty is limited to repairing or replacing at its factory this product which shall be returned to the factory within three years after the original purchase and which on examination is found to contain defects in material and workmanship. **DIG CORPORATION SHALL IN NO EVENT BE LIABLE FOR ANY INCIDENTAL OR CONSEQUENTIAL DAMAGES OF ANY KIND; THE SOLE OBLIGATION OF DIG BEING LIMITED TO REPAIR OR REPLACEMENT OF DEFECTIVE PRODUCTS. SOME STATES DO NOT ALLOW THE EXCLUSION OR LIMITATION OF INCIDENTAL OR CONSEQUENTIAL DAMAGES, SO THE ABOVE LIMITATION OR EXCLUSION MAY NOT APPLY TO YOU.**

Unattended use for prolonged periods without inspection to verify proper operation is beyond the intended use of this product, and any damage resulting from such use shall not be the responsibility of DIG CORPORATION. There are no warranties, which extend beyond the description on the face hereof. In the case of purchase of the product for use other than, for irrigation purposes, DIG CORPORATION hereby disclaims any implied warranties including any warranties of merchantability and fitness for a particular purpose. In the case of the purchase of the product for personal, family or household purposes, DIG CORPORATION disclaims any such warranties to the extent permitted by law. To the extent that any such disclaimer or implied warranties shall be ineffectual, then any implied warranties shall be limited in duration to a period of three years from the date of the original purchase for use by the purchaser. Some states do not allow limitation on how long an implied warranty lasts, so the above limitation may not apply to you.

In order to obtain performance under this warranty, the unit must be returned to the factory, along with proof of purchase indicating original date of purchase, shipping prepaid, addressed as follows:

DIG CORPORATION, 1210 Activity Drive, Vista, CA 92081. Repaired or replaced units will be shipped prepaid to the name and address supplied with the unit returned under warranty. Allow four weeks for repairs and shipping time. Repair of damaged units not otherwise within warranty may be refused or done at a reasonable cost or charge at the option of DIG CORPORATION.

This warranty gives you specific legal rights, and you may also have other rights, which vary from state to state.



## 18. TECHNICAL ASSISTANCE

Should you encounter any problem(s) with this product or if you do not understand its many features, please refer to this operating manual first. If further assistance is required DIG offers the following customer support:

### DIGPRO™ Technical Service USA

DIG's Technical Service Team is available to answer questions in English and Spanish from 8:00 AM to 5:00 PM (PST) Monday-Friday (except holidays) at 800-344-2281.

Questions can be e-mailed to [questions@digcorp.com](mailto:questions@digcorp.com) or faxed to 760-727-0282.

Specification documents and manuals are available for download at [www.digcorp.com](http://www.digcorp.com).

### Customer Assistance Outside the USA

Contact your local distributor.

## 19. TO ORDER REPLACEMENT OR SPARE PARTS: PLEASE ORDER ONLINE AT [WWW.DIGCORP.COM](http://WWW.DIGCORP.COM)

We at DIG Corporation understand that most dealers do not carry spare parts. For your convenience, if you need one of these parts, please order online at [www.digcorp.com](http://www.digcorp.com).

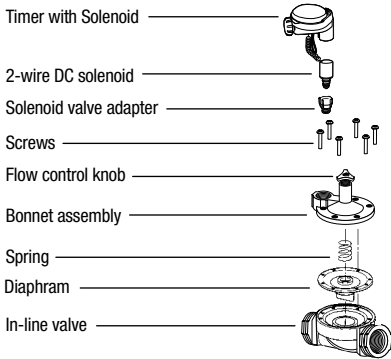



1210 Activity Drive  
Vista, CA 92081-8510, USA

Website:

[www.digcorp.com](http://www.digcorp.com)

e-mail: [dig@digcorp.com](mailto:dig@digcorp.com)

26-221 REV C 082415

Printed in the USA

DIG is a Registered Service Mark of DIG Corp.

