



USER MANUAL

VeSync Core™ Pro 400S PlasmaPro Smart Air Purifier

Product Series: Core 400S

Model: LAP-C401S-WUSR

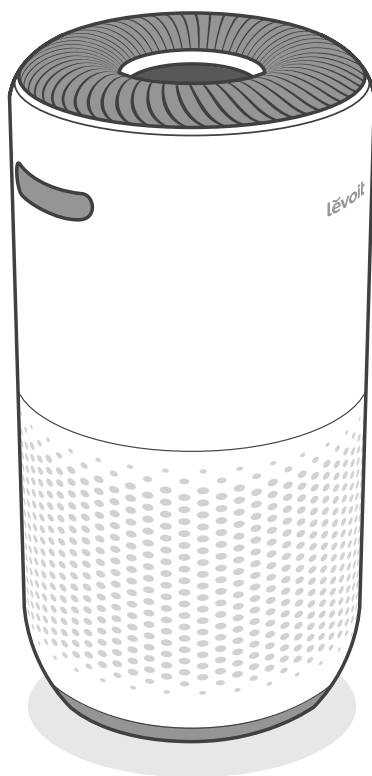

Questions or Concerns?

Please contact us Mon–Fri, 9:00 am–5:00 pm PST/PDT
at support@levoit.com or at **(888) 726-8520**.

Table of Contents

Package Contents	2
Specifications	2
Safety Information	3
Getting to Know Your Smart Air Purifier	5
Controls & Display	6
Getting Started	7
Using Your Smart Air Purifier	8
About the Filter	13
Care & Maintenance	15
Troubleshooting	17
Warranty Information	21
Customer Support	22

Package Contents

- 1 x Smart Air Purifier
- 1 x True HEPA 3-Stage Original Filter
(Pre-Installed)
- 1 x User Manual
- 1 x Quick Start Guide

Specifications

Power Supply	AC 120V, 60Hz
Rated Power	38W
Ideal Room Size	403 ft ² / 37 m ² This Ideal Room Size is based on 5 air changes per hour (ACH). 990 ft ² / 92 m ² This Ideal Room Size is based on 2 air changes per hour (ACH). Note: Effective for larger rooms but purification will take longer.
CADR (CFM)	260 CFM / 442 m ³ /h
Operating Conditions	Temperature: 14°–104°F / -10°–40°C Humidity: < 85% RH
Noise Level	24–52dB
Dimensions	10.8 x 10.8 x 20.5 in / 27.4 x 27.4 x 52 cm
Weight	11 lb / 5 kg

Note: To access additional smart functions, download the free VeSync app (see page 8).

READ AND SAVE THESE INSTRUCTIONS

SAFETY INFORMATION

To reduce the risk of fire, electric shock, or other injury, follow all instructions and safety guidelines.

General Safety

- **Only** use your air purifier as described in this manual.
- **Do not** use without removing the plastic wrap from the filter. The air purifier will not filter air, and may overheat, causing a fire hazard.
- **Do not** use the air purifier outdoors.
- Keep the air purifier away from water, and wet or damp areas. **Never** place in water or liquid.
- **Do not** use in excessively humid areas.
- Keep the air purifier away from heat sources.
- **Do not** use where combustible gases, vapors, metallic dust, aerosol (spray) products, or fumes from industrial oil are present.
- Keep 5 ft / 1.5 m away from where oxygen is being administered.
- Supervise children when they are near the air purifier.
- **Do not** place anything into any opening in the air purifier.
- **Do not** sit on or place heavy objects on the air purifier.
- Keep the inside of the air purifier dry. To prevent moisture buildup, avoid placing in rooms with major temperature changes or underneath air conditioners.
- **Always** unplug the air purifier before servicing (such as changing the filter).
- **Do not** use the air purifier if it is damaged or not working correctly, or if the cord or plug is damaged. **Do not** try to repair it yourself. Contact **Customer Support** (see page 22).
- **WARNING:** To reduce the risk of fire or electric shock, **do not** use this air purifier with any solid-state speed controls (such as a dimmer switch).
- Children should not clean or perform maintenance on the air purifier without supervision.
- This air purifier is not to be used by persons (including children) with reduced physical, sensory, or mental capacities, or lack of experience and knowledge, unless they have been given supervision or instruction concerning the use of the appliance by a person responsible for the safety.
- Not for commercial use. Household use **only**.

Power & Cord

- Keep the air purifier near the outlet it is plugged into.
- **Never** place the cord near any heat source.
- **Do not** cover the cord with a rug, carpet, or other covering. **Do not** place the cord under furniture or appliances.
- Keep the cord out of areas where people walk often. Place the cord where it will not be tripped over.
- This air purifier has a polarized plug (one blade is wider than the other). To reduce the risk of electric shock, this plug is intended to fit in a polarized outlet only one way. If the plug does not fit fully in the outlet, reverse the plug. If it still does not fit, contact a qualified electrician. **Do not** attempt to defeat this safety feature.

SAFETY INFORMATION (CONT.)

- This air purifier uses standard North American 120V, 60Hz outlets. If using outside the US or Canada, check for compatibility.
- If the power supply cord is damaged, it must be replaced by Arovast Corporation or similarly qualified persons in order to avoid an electric or fire hazard. Please contact **Customer Support** (page 22).

Electromagnetic Fields (EMF)

Your Levoit air purifier complies with all standards regarding electromagnetic fields (EMF). If handled properly and according to the instructions in this user manual, the appliance is safe to use based on scientific evidence available today.

GETTING TO KNOW YOUR SMART AIR PURIFIER

- A. Fan Speed Indicators
- B. Fan Speed Button
- C. Sleep Mode Button
- D. Air Quality Indicator Rings
- E. Plasma Button
- F. Check Filter Indicator
- G. Timer Button
- H. On/Off Button
- I. Wi-Fi® Indicator
- J. Auto Mode Button
- K. PM2.5/Timer Display
- L. Display Off Button
- M. Display Lock Indicator
- N. Display Lock Button
- O. Air Outlets
- P. Housing
- Q. Air Inlets
- R. AirSight Plus™ Laser Dust Sensor
- S. Anti-Skid Pads
- T. Filter Cover
- U. True HEPA 3-Stage Original Filter

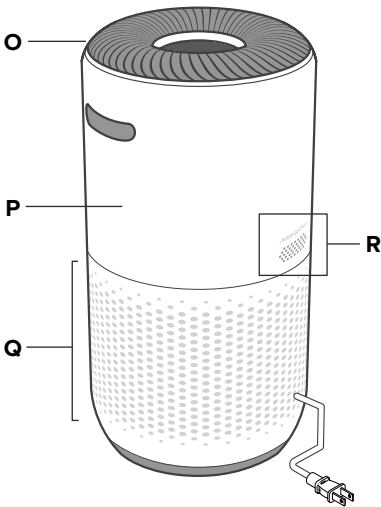
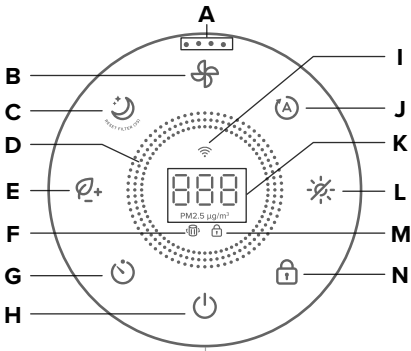

Back

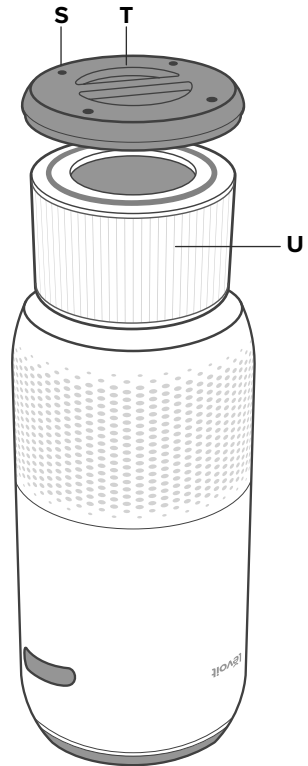

Front, upside down

CONTROLS & DISPLAY



On/Off Button

- Turns the air purifier on/off.
- Press and hold to configure the air purifier. See the VeSync in-app instructions for more information.
- Press and hold to reset the air purifier and disconnect from Wi-Fi (see page ___).



Air Quality Indicator Rings

- These indicators use an automatic sensor to display the air quality: Blue (Very Good), Green (Good), Orange (Moderate), and Red (Bad).



Wi-Fi® Indicator

- Turns on, off, or blinks to indicate pairing status. See the VeSync in-app instructions for more information.



Fan Speed Button

- Cycles through fan speeds: low (1 indicator will light up), medium (2 indicators), high (3 indicators), and turbo (4 indicators).
- Tapping the Fan Speed Button while the air purifier is in Auto Mode or Sleep Mode (if the display is on) will exit that mode.



Sleep Mode Button

- Turns Sleep Mode on/off (see page 9).
- Press and hold for 3 seconds to reset the Check Filter Indicator (see page 15).



Timer Button

- Cycles through timer options (see page 10).
- Press and hold  for 2 seconds to begin cycling through the timer options in 1-hour increments.



Auto Mode Button

- Turns Auto Mode on/off (see page 9).



Display Off Button

- Turns the display off (see page 10).
- Tap any button (except ) to turn the display back on.



Display Lock Button

- Prevents current settings from being changed (see page 10). Press and hold for 3 seconds to turn Display Lock on/off.
- The Display Lock Indicator () will blink when any other button is tapped to indicate that Display Lock is on.



Plasma Button

- Turns the Plasma function on/off (see page 11).

GETTING STARTED

1. Flip the air purifier over or turn it on its side. Twist the filter cover counterclockwise and remove it. [Figure 1.1]

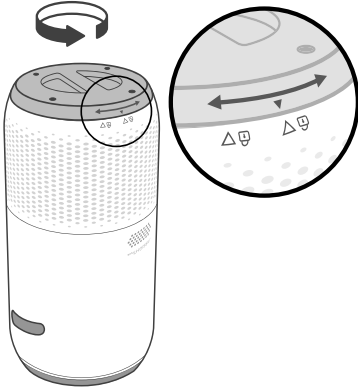

Figure 1.1

3. Replace the filter cover and twist clockwise to lock. [Figure 1.3]

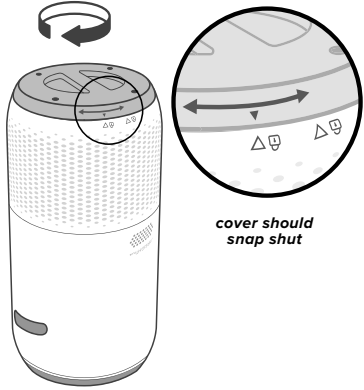

Figure 1.3

2. Remove the filter from its plastic packaging and place the filter back into the air purifier. [Figure 1.2]

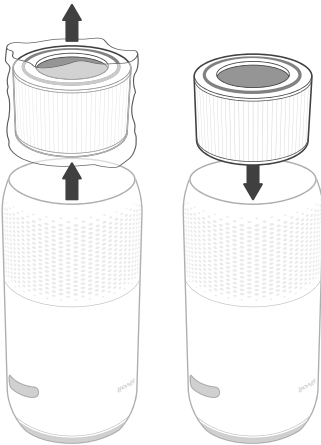

Figure 1.2

4. Place the purifier on a flat, stable surface with the display facing up. Allow at least 15 inches / 38 cm of clearance on all sides. Keep away from anything that would block airflow, such as curtains. [Figure 1.4]

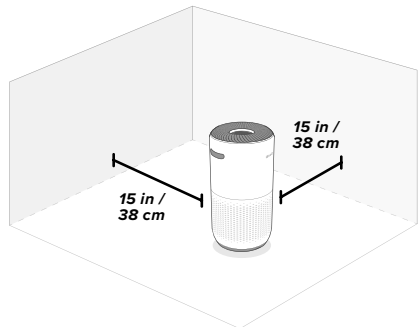

Figure 1.4

VeSync App Setup

1. To download the VeSync app, scan the QR code or search “VeSync” in the Apple App Store® or Google Play Store.
2. Open the VeSync app. **Log In** or **Sign Up**.
3. Follow the in-app instructions to set up your smart air purifier.



Note:

- To disconnect Wi-Fi, press and hold the On/Off button for 15 seconds until the Wi-Fi indicator turns off. This will restore the smart air purifier's default settings and disconnect it from the VeSync app.
- To reconnect, please follow the instructions in the VeSync app for adding a device.



Connect with Amazon Alexa or Google Assistant™

You can use the VeSync app to connect your smart air purifier to **Amazon Alexa** or **Google Assistant™**. Please follow the in-app instructions to set up your voice assistant.

Note: You must create your own VeSync account to access voice assistants.

USING YOUR SMART AIR PURIFIER

Note: Using the VeSync app allows you to control your air purifier remotely and access additional functions and features.

1. Plug in and tap  to turn on the air purifier. The fan will start on low speed. [Figure 2.1]
2. Optionally, tap  to change fan speed between low, medium, high, and turbo.

Note:

- The fan speed indicators will light up when active. 1 indicator will light up for low, 2 for medium, 3 for high, and 4 for turbo.
- Turbo speed is the loudest, but cleans air the quickest.
- For best results, or to address a specific air quality issue such as smoke, run the air purifier at turbo speed for 15–20 minutes before using a lower speed.
- To effectively clean air, keep windows and doors closed while the air purifier is on.

3. Tap  to turn off the air purifier.

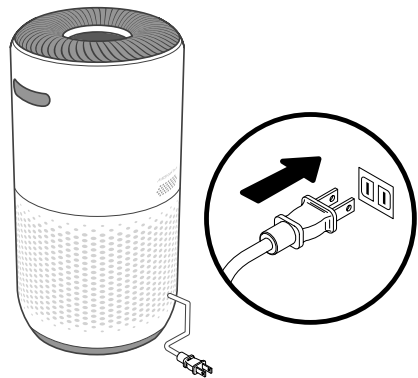



Figure 2.1

USING YOUR PURIFIER (CONT.)

Sleep Mode

Sleep Mode operates quietly by using a fan speed lower than low speed.

1. Tap  to turn Sleep Mode on/off.
2. Sleep Mode will turn off the display after 3 seconds if no other buttons are tapped.

Note:

- When the display is turned off, tap any button (except ) to turn the display back on. If you don't tap another button, the display will turn off again after 3 seconds.
- The Check Filter Indicator will still turn on and stay on if it's time to check your filter (see page 15).
- You cannot use the plasma function during Sleep Mode.
- The Sleep Mode button is also used to reset the Check Filter Indicator (see page 15). Press and hold for 3 seconds.

Auto Mode

Auto Mode uses AirSight Plus™, a smart laser dust sensor inside the air purifier, to adjust the fan speed automatically based on air quality. For example, if the air quality is bad, the fan will automatically be set to high speed.

Note:

- The air purifier will take 5 seconds to detect the air quality each time it is turned on. During this time, the air quality indicator rings will be blue. After 5 seconds, the air quality indicator rings will change color based on the detected air quality.
- Auto Mode does not use the turbo fan speed.
- The VeSync app also supports additional auto modes: Quiet Auto Mode and Efficient Auto Mode (see page 11).

PM2.5 Display

The PM2.5 value on the display shows the amount of airborne particles (μg) that are detected per 1 cubic meter (m^3) of air volume.

PM2.5 refers to particulate matter (PM) that is less than or equal to 2.5 microns (μm) in diameter. These particles, also known as “fine particles”, are so small that they can only be detected with an electron microscope, and they stay in the air longer than heavier particles such as dust and mold.



Your air purifier's AirSight Plus Laser Dust Sensor detects the amount of PM2.5 particles that are in a given space ($\mu\text{g}/\text{m}^3$). Generally, the lower the number, the better your air quality. A number above 115 indicates that there is an unhealthy amount of fine particles in the air.

Air Quality Indicator Chart			
Indicator Color	Air Quality	Auto Mode Fan Speed	PM2.5 Range
Blue	Very Good	Sleep Mode	0–35 $\mu\text{g}/\text{m}^3$
Green	Good	Low	36–75 $\mu\text{g}/\text{m}^3$
Orange	Moderate	Medium	76–115 $\mu\text{g}/\text{m}^3$
Red	Bad	High	> 115 $\mu\text{g}/\text{m}^3$

USING YOUR PURIFIER (CONT.)

Timer



You can set a timer for 1–12 hours.

1. Tap . The display will switch from showing the PM2.5 reading to the time you've selected.
2. Tap  repeatedly to select a time in 1-hour increments. If you don't touch any buttons for 5 seconds, the display will switch to showing the PM2.5 reading and the timer will start automatically.

Note: Press and hold  for 2 seconds to cycle through timer options automatically in 1-hour increments.

3. The timer will count down from your selected time.

Note:

- While a timer is active, tapping  will show the remaining time, rounded up to the nearest hour. Tap  again within 5 seconds to add more time in 1-hour increments.
- You can see the exact remaining time in the VeSync app.





4. When the timer is finished, the air purifier will turn off.
5. To cancel a timer, tap  repeatedly until the display reads "--H".

Note:

- You can change the fan speed at any time while the timer is on.
- The timer will restart if the time is changed.
- The air purifier will remember the last timer setting while turned off, but the timer will be cancelled and need to be restarted.
- You can set a timer for 1–24 hours in the VeSync app.

Display Off



This turns off the display lights on the air purifier, including button lights and indicator lights (except the Check Filter Indicator).

1. Tap  to turn off the display.
2. Tap any button (except  or ) to temporarily turn the display back on. If you don't tap another button, the display will turn back off after 3 seconds.
3. Tap  to turn the display back on. The display will stay on.



Note: The Check Filter Indicator will still turn on and stay on if it's time to check your filter (see page 15).

Display Lock

When the air purifier is on, you can lock the display to prevent settings from being accidentally changed. Buttons will not respond to being tapped.

1. Press and hold  for 3 seconds to lock the display. The  indicator will light up in the center of the display.

Note: If the display is turned off, the  indicator will flash 3 times to show that the display has been locked, then turn off.

2. The  indicator will blink when any other button is tapped to indicate that Display Lock is on.
3. Tap and hold  again for 3 seconds to unlock the display. The  indicator will turn off.

Note:

- If the display is turned off, the  indicator will flash 3 times to show that the display has been unlocked.
- Display Lock can still be used when the air purifier is in Standby Mode.

USING YOUR PURIFIER (CONT.)

Standby Mode

The air purifier is in Standby Mode when it is turned off, but plugged in.

Note: *Display Lock can be used while the air purifier is in Standby Mode to keep the air purifier from being turned back on. The laser dust sensor will still detect the surrounding air quality and give you updates in the VeSync app.*

Memory Function

When the air purifier is plugged in and turned off, it will remember its previous fan speed, Sleep Mode, Auto Mode, Display Lock, Display Off, and Plasma settings.

When you unplug the air purifier, it will only remember its previous fan speed, Sleep Mode, and Auto Mode.

Note: *The air purifier will remember the last timer setting chosen (1–12 hours), but it will not automatically resume the timer. You will need to restart the timer after the air purifier is turned back on.*

Plasma Function

The plasma function uses PlasmaPro™ technology to generate positive and negative ions that bind with pollutants and neutralize them by breaking down their molecular structure.

This helps neutralize particulate matter, odorous gases, aerosols, and volatile organic compounds (VOCs).

Note: *You cannot use the plasma function during Sleep Mode.*

VeSync App Functions

The VeSync app allows you to access additional smart air purifier functions, including those listed below. As the app develops, more features may become available.

Remote Control

- Change any air purifier settings through the app, even while Display Lock is on.

Air Quality Updates

- View real-time PM2.5 updates in the app.
- See your air quality history for the previous week.

Auto Mode

- Access additional Auto Modes: Quiet Auto Mode and Efficient Auto Mode.
- Quiet Auto Mode uses medium fan speed instead of the high or turbo fan speeds, even when the air quality is poor, to avoid making too much noise.
- Efficient Auto Mode lets you choose the size of the area you want to purify. The air purifier will use the highest fan speed (turbo) to clean the air for a designated amount of time. This time is based on ACH 1 and the size of the room, meaning how long it takes for the air purifier to clean all the air in your room one time, regardless of the air quality. After this, the mode will adjust the fan speed according to the actual detected air quality in the room.

Note: *Efficient Auto Mode is useful for purifying odors from the air. The air purifier's sensor can only detect particles in the air, not smells. Efficient Auto Mode does not rely on the sensor, but the room size instead.*

USING YOUR PURIFIER (CONT.)

Schedules

- Create and customize schedules for your air purifier to match your routines.

Timer Function

- Set a timer between 1–24 hours.
- Easily view the exact time remaining on a timer.

Filter Replacement Info

- Keep tabs on the remaining filter life by checking the filter life percentage in the app.
- Shop for replacement filters.

ABOUT THE FILTER

The air purifier uses a 3-stage filtration system to purify air.

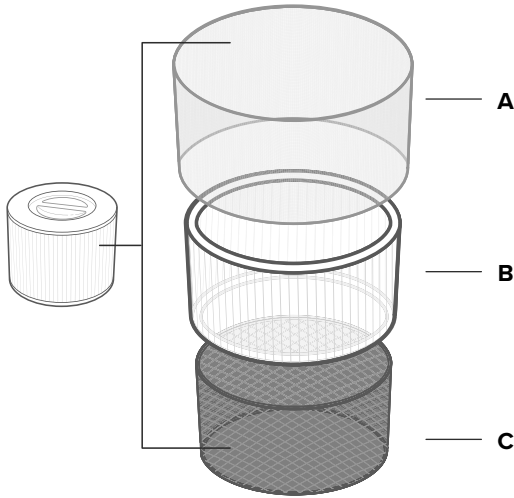

A. Pre-Filter

- Captures large particles such as dust, lint, fibers, hair, and pet fur.
- Maximizes the filter's life by protecting it.

B. H13 True HEPA Filter

- Captures at least 99.97% of airborne particles 0.3 microns (μm) in size.
- Traps small particles such as fine dust, smoke particles, and allergens such as pollen and pet dander.

C. Custom High-Efficiency Activated Carbon Filter

- Physically adsorbs smoke, odors, and fumes.
- Customized using Levoit's exclusive ARC Formula™ to be especially effective for cooking smells and pet odors in a multi-pet household.
- The ARC Formula extends the life of the filter by chemically decomposing molecules trapped within the Activated Carbon Filter, which prevents oversaturation and second-hand pollution.
- Filters compounds such as formaldehyde, benzene, ammonia, hydrogen sulfide, and volatile organic compounds (VOCs).

Note: This air purifier includes an optional Plasma Function, which is a 4th filtration stage that helps neutralize some pollutants (see page 11).

ABOUT THE FILTER (CONT.)

Clean Air Delivery Rate

This air purifier has a Clean Air Delivery Rate of 260 cubic feet per minute (CFM), or 442 m³/h.

Clean Air Delivery Rate (CADR) measures the efficiency of an air purifier by indicating the volume of clean air that an air purifier produces per minute. This is based on removal of dust, pollen, and smoke, which are the 3 most common indoor air pollutants. The higher the CADR, the more particles the air purifier will remove and the larger the area it can clean. The rating is measured at the air purifier's highest speed.

Air Change Per Hour

The air change rate is how many times all of the air in a room can be purified (or "changed") by the air purifier in 1 hour. Air changes per hour (ACH) are calculated with the recommended room size assuming 8 ft / 2.4 m ceilings. For smaller rooms, the air change per hour will increase. This air purifier can change air 5 times per hour at the max speed in a single, closed room up to 403 ft² / 37 m². This is measured at ACH 5. The air purifier is effective for larger rooms, but air purification will take longer, with fewer air changes per hour. For example, the air purifier's effective range is 990 ft² / 92 m² based on 2 ACH, or purifying the air in the room 2 times per hour.

Note: To effectively clean air, keep windows and doors closed while the air purifier is on.

Humidity

Moisture may damage the filter. This air purifier should be used in an area with a humidity level below 85% RH. If you use the air purifier in excessively humid areas, the surface of the filter may become moldy.

Note: Water or moisture will allow mold to grow. To solve a mold problem, get rid of the source of the moisture and clean up the mold.

Essential Oils



Do not add essential oils to the air purifier or filter. The filter will become damaged by the oil and will eventually release an unpleasant smell. **Do not** use diffusers near the air purifier.

CARE & MAINTENANCE

Cleaning the Smart Air Purifier

- Unplug before cleaning.
- Wipe the outside of the air purifier with a soft, dry cloth. If necessary, wipe the housing with a damp cloth, then immediately dry.
- Vacuum the inside of the air purifier.
- **Do not** clean with abrasive chemicals or flammable cleaning agents.

Check Filter Indicator

 will light up as a reminder to check the filter. Depending on how often you use the air purifier, the indicator should turn on at about 12 months. You may not need to change your filter yet, but you should check it when  turns on.

When your air purifier is set up with the VeSync app, you can also check the app to see your remaining filter life. You will also receive a notification from VeSync when it's time to check your filter.







The VeSync app uses a scientific algorithm to determine your filter life based on air quality, amount of use, and other factors. The filter life percentage is based on 12 hours of daily use.

Cleaning the Filter

The outer pre-filter should be cleaned every 2–4 weeks to increase efficiency and extend the life of your filter. Clean the pre-filter using a soft brush or vacuum hose to remove hair, dust, and large particles. **Do not** clean the filter with water or other liquids.

Resetting the Check Filter Indicator

Reset the Check Filter Indicator when:

- A.  lights up red.**
1. Replace the filter (see page 16).
 2. Turn on the air purifier.
 3. Press and hold the  button for 3 seconds.
 4.  will turn off when successfully reset.
- B. The filter was changed before  lit up.**
1. Press and hold the  button for 3 seconds.
 2. The  will flash for 3 seconds.
 3.  will turn off when successfully reset.

Filter	When to Clean	How to Clean	When to Replace
Pre-Filter	Every 2–4 weeks	Use a soft brush or vacuum hose	12 months
True HEPA & Activated Carbon Filter	Do not clean		

CARE & MAINTENANCE (CONT.)

When Should I Replace the Filter?

The filter should be replaced every 12 months. You may need to replace your filter earlier or later depending on how often you use your air purifier. Using your air purifier in an environment with relatively high pollution may mean you will need to replace the filter more often, even if  is off.

You may need to replace your filter if you notice:

- Increased noise when the air purifier is on
- Decreased airflow
- Unusual odors
- A visibly clogged filter

Note:

- *To maintain the performance of your air purifier, **only** use official Levoit filters. To buy replacement filters, visit Levoit's online store. Go to [levoit.com](https://www.levoit.com) for more information.*
- *Remember to reset  after changing the filter (see page 15).*

Cleaning the AirSight Plus Laser Dust Sensor

The AirSight Plus Laser Dust Sensor can be blocked by dust, which affects the sensor's accuracy. Clean the sensor every 3 months. Using your air purifier in an environment with more dust may mean you will need to clean the sensor more often.

1. Unplug the air purifier.
2. Place the end of a vacuum cleaner over the sensor openings. *[Figure 3.3]*
3. Turn the vacuum on for at least 10 seconds to clean out dust.

Replacing the Filter

1. Unplug the air purifier. Flip the air purifier over or turn it on its side. Remove the filter cover (see **Getting Started**, page 7).
2. Remove the old filter.
3. Clean out any remaining dust or hair inside the air purifier using a vacuum hose. **Do not** use water or liquids to clean the air purifier. *[Figure 3.2]*
4. Unwrap the new filter and place it into the housing (see **Getting Started**, page 7).
5. Replace the cover. Plug in the air purifier.
6. Reset the Check Filter Indicator (see page 15).

Storage

If not using the air purifier for an extended period of time, wrap both the air purifier and the filter in plastic packaging and store in a dry place to avoid moisture damage.

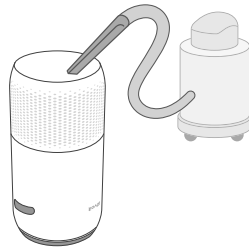

Figure 3.2

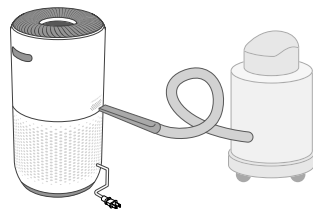











Figure 3.3

TROUBLESHOOTING

Problem	Possible Solution
<p>Air purifier will not turn on or respond to button controls.</p>	<p>Plug in the air purifier.</p>
	<p>Check to see if the power cord is damaged. If it is, stop using the air purifier and contact Customer Support (see page 22).</p>
	<p>Plug the air purifier into a different outlet.</p>
	<p>The air purifier may be malfunctioning. Contact Customer Support (see page 22).</p>
<p>Airflow is significantly reduced.</p>	<p>Make sure the filter is removed from its packaging and properly in place (see page 7).</p>
	<p>Tap  to increase the fan speed.</p>
	<p>Leave 15 inches / 38 cm of clearance on all sides of the air purifier.</p>
	<p>The pre-filter may be clogged by large particles, such as hair or lint, blocking airflow. Clean the pre-filter (see page 15).</p>
	<p>Replace the filter (see page 16).</p>
<p>Air purifier makes an unusual noise while the fan is on.</p>	<p>Make sure the filter is properly in place with plastic packaging removed (see page 7).</p>
	<p>Make sure the air purifier is operating on a hard, flat, level surface.</p>
	<p>Replace the filter (see page 16).</p>
	<p>The air purifier may be damaged, or a foreign object may be inside. Stop using the air purifier and contact Customer Support (see page 22). Do not try to repair the air purifier.</p>
<p>Strange smell coming from the air purifier.</p>	<p>Clean the filter, or replace if necessary.</p>
	<p>Contact Customer Support (see page 22).</p>
	<p>Make sure not to use your air purifier in an area with high humidity or while diffusing essential oils.</p>

TROUBLESHOOTING (CONT.)

Problem	Possible Solution
Poor air purification quality.	Tap  to increase the fan speed.
	Make sure no objects are blocking the sides or top of the air purifier (the inlet or outlet).
	Make sure the filter is removed from its packaging and properly in place (see page 7).
	Close doors and windows while using the air purifier.
	If the room is larger than 403 ft ² / 37 m ² , air purification will take longer.
	Replace the filter (see page 16).
 is still on after replacing the filter.	Reset the Check Filter Indicator (see page 15).
 has not turned on within 12 months.	 is a reminder for you to check the filter and will light up based on how much the air purifier has been used (see page 15). If you don't use your air purifier often,  will take longer to turn on.
 turned on before 12 months.	 is a reminder for you to check the filter and will light up based on how much the air purifier has been used (see page 15). If you run your air purifier frequently,  will turn on sooner.
Air Quality Indicator always stays red.	The AirSight Plus Laser Dust Sensor may need to be cleaned (see page 16).
	If you're using an ultrasonic humidifier near the air purifier, the mist may affect the accuracy of the AirSight Plus Laser Dust Sensor. The sensor will detect the large mist particles, and the Air Quality Indicator may turn red. Avoid using an ultrasonic humidifier near the air purifier, or avoid using Auto Mode.
Air Quality Indicator always stays blue, even when the air quality is poor.	The AirSight Plus Laser Dust Sensor detects airborne particles, but it cannot detect gas. Make sure there isn't gas polluting the air.
Display shows Error Code "E1".	The motor has malfunctioned. Please contact Customer Support (see page 22).

If your problem is not listed, please contact **Customer Support** (see page 22).

VESYNC APP TROUBLESHOOTING

My smart air purifier isn't connecting to the VeSync app.

- Make sure your phone has Bluetooth® turned on and is not currently connected to another Bluetooth device.
- During the setup process, you must be on a secure 2.4GHz Wi-Fi® network. Confirm that the network is working correctly.
- Make sure the Wi-Fi password you entered is correct.
 - There should be no spaces at the beginning or end of the password.
 - Test the password by connecting a different electronic device to the router.
 - If you're manually typing in the SSID and password, double check that both are entered correctly.
- Try moving your air purifier closer to the router. Your phone should be as close as possible to your air purifier.
- Your router may need to be at a higher location, away from obstructions.
- Make sure your air purifier and router are away from appliances (such as microwave ovens, refrigerators, electronic devices, etc.) to avoid signal interference.
- If you're using a VPN, make sure it's turned off while setting up your air purifier.
- Disable portal authentication for your Wi-Fi network. If portal authentication is enabled, the air purifier will not be able to access your Wi-Fi network, and setup will fail.

Note: *Portal authentication means that you need to sign in to your Wi-Fi network through a web page before you can use the Internet.*

My air purifier is offline.

- Make sure the air purifier is plugged in and has power, then refresh the VeSync menu by swiping down on the screen.
- Make sure your router is connected to the internet and your phone's network connection is working.
- Delete the offline air purifier from the VeSync app. Swipe left (iOS®) or press and hold (Android™), then tap **Delete**. Reconfigure the air purifier with the VeSync app.

Note: *Power outages, internet outages, or changing Wi-Fi routers may cause the air purifier to go offline.*

If your problem is not listed, please contact **Customer Support** (see page 22).

FEDERAL COMMUNICATION COMMISSION INTERFERENCE STATEMENT – PART 15

This device complies with Part 15 of the FCC Rules. Operation is subject to the following two conditions:

1. This device may not cause harmful interference, and
2. This device must accept any interference received, including interference that may cause undesired operation.

NOTE: This equipment has been tested and found to comply with the limits for a Class B digital device, pursuant to Part 15 of the FCC Rules. These limits are designed to provide reasonable protection against harmful interference in a residential installation. This equipment generates, uses and can radiate radio frequency energy and, if not installed and used in accordance with the instructions, may cause harmful interference to radio communications. However, there is no guarantee that interference will not occur in a particular installation. If this equipment does cause harmful interference to radio or television reception, which can be determined by turning the equipment off and on, the user is encouraged to try to correct the interference by one or more of the following measures:

- Reorient or relocate the receiving antenna.
- Increase the separation between the equipment and receiver.
- Connect the equipment into an outlet on a circuit different from that to which the receiver is connected.
- Consult the dealer or an experienced radio/TV technician for help.

FCC Caution: Any changes or modifications not expressly approved by the party responsible for compliance could void the user's authority to operate this equipment.

FCC RADIATION EXPOSURE STATEMENT

This equipment complies with FCC radiation exposure limits set forth for an uncontrolled environment. End users must follow the specific operating instructions for satisfying RF exposure compliance. To maintain compliance with FCC RF exposure compliance requirements, please follow operation instructions as documented in this manual. This transmitter must not be co-located or operating in conjunction with any other antenna or transmitter. This equipment should be installed and operated with a minimum distance of 20cm between the radiator and your body. The availability of some specific channels and/or operational frequency bands are country dependent and are firmware programmed at the factory to match the intended destination. The firmware setting is not accessible by the end user.

WARRANTY INFORMATION

Product Name	VeSync Core Pro 400S Smart True HEPA Air Purifier
Model	LAP-C401S-WUSR
<i>For your own reference, we strongly recommend that you record your order ID and date of purchase.</i>	
Date of Purchase	
Order ID	

Terms & Policy

Arovast Corporation (“Arovast”) warrants this product to the original purchaser to be free from defects in material and workmanship, under normal use and conditions, for a period of 2 years from the date of original purchase.

Arovast agrees, at our option during the warranty period, to repair any defect in material or workmanship or furnish an equal product in exchange without charge, subject to verification of the defect or malfunction and proof of the date of purchase.

There is no other express warranty. This warranty does not apply:

- If the product has been modified from its original condition;
- If the product has not been used in accordance with directions and instructions in the user manual;
- To damages or defects caused by accident, abuse, misuse or improper or inadequate maintenance;
- To damages or defects caused by service or repair of the product performed by an unauthorized service provider or by anyone other than Arovast;
- To damages or defects occurring during commercial use, rental use, or any use for which the product is not intended;
- To damages or defects exceeding the cost of the product.

Arovast will not be liable for indirect, incidental, or consequential damages in connection with the use of the product covered by this warranty.

This warranty extends only to the original consumer purchaser of the product and is not transferable to any subsequent owner of the product regardless of whether the product is transferred during the specified term of the warranty.

This warranty does not extend to products purchased from unauthorized sellers. Arovast’s warranty extends only to products purchased from authorized sellers that are subject to Arovast’s quality controls and have agreed to follow its quality controls.

All implied warranties are limited to the period of this limited warranty.

This warranty gives you specific legal rights and you may also have other rights which vary from state to state. Some states do not allow the exclusion or limitation of incidental or consequential damages, so the above limitation or exclusion may not apply to you.

If you discover that your product is defective within the specified warranty period, please contact Customer Support via **support@levoit.com**. **DO NOT** dispose of your product before contacting us. Once our Customer Support Team has approved your request, please return the product with a copy of the invoice and order ID.

Every Levoit product automatically includes a 2-year warranty. To make the customer support process quick and easy, register your product online at www.levoit.com/warranty.

This warranty is made by:

Arovast Corporation
1202 N. Miller St., Suite A
Anaheim, CA 92806

CUSTOMER SUPPORT

If you have any questions or concerns about your new product, please contact our helpful Customer Support Team.

Distributed by Arovast Corporation

1202 N. Miller St., Suite A
Anaheim, CA 92806

Email: support@levoit.com

Toll-Free: (888) 726-8520

Support Hours

Mon–Fri, 9:00 am–5:00 pm PST/PDT

*Please have your order invoice and order ID ready before contacting Customer Support.

ATTRIBUTIONS

Amazon, Alexa, and all related logos are trademarks of Amazon.com, Inc. or its affiliates.

Google, Android, and Google Play are trademarks of Google LLC.

App Store® is a trademark of Apple Inc.

Wi-Fi® is a registered trademark of Wi-Fi Alliance®.

iOS is a registered trademark of Cisco Systems, Inc. and/or its affiliates in the United States and certain other countries.

The Bluetooth® word mark and logos are registered trademarks owned by Bluetooth SIG, Inc. and any use of such marks by Arovast Corporation is under license. Other trademarks and trade names are those of their respective owners.



/LEVOITLIFESTYLE



/LEVOIT



/LEVOIT



/LEVOIT



LEVOIT.COM

lëvoit[®]