

ASSEMBLY INSTRUCTIONS

SKU CODE: WF287260/WF287261

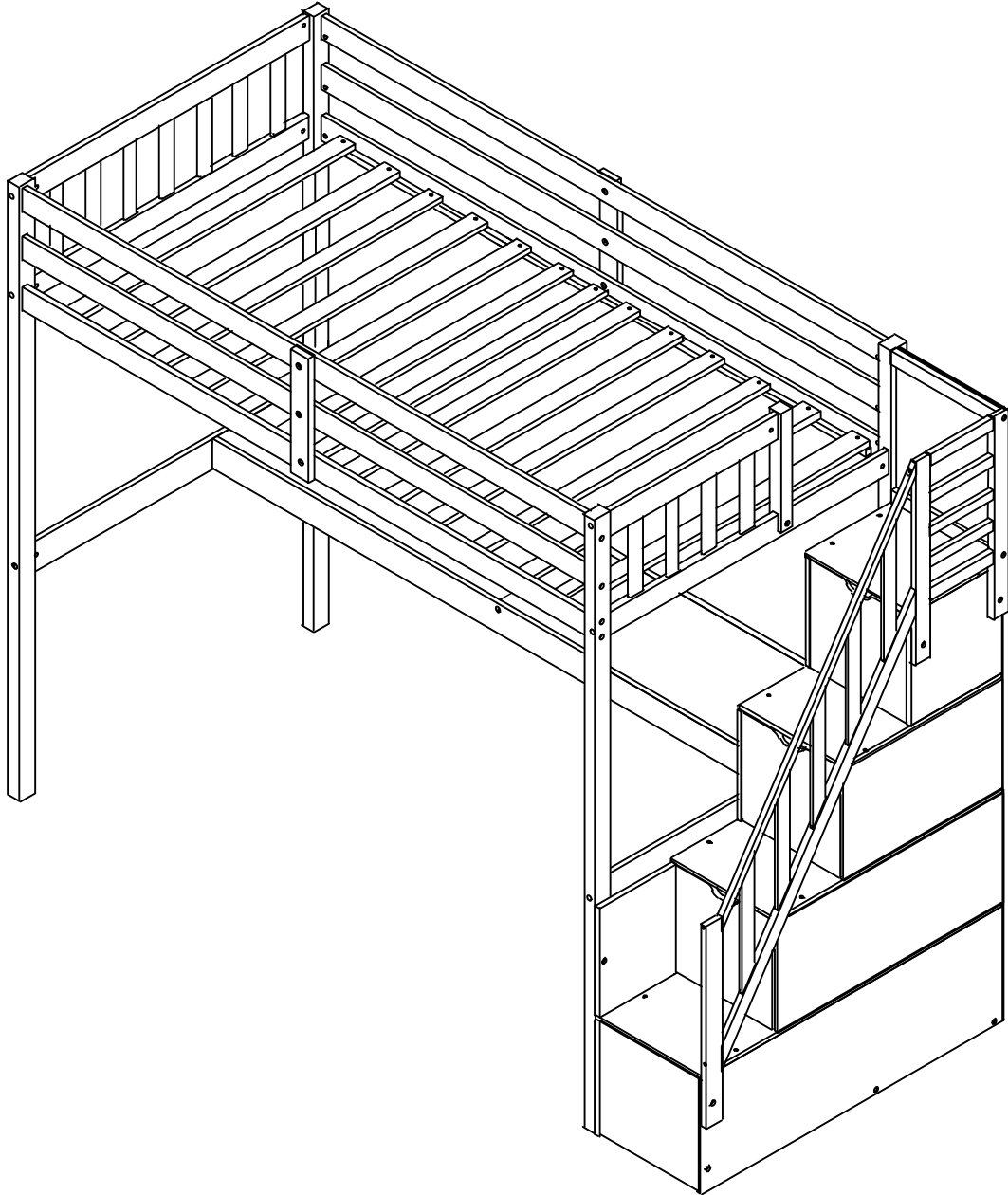

**SAFETY WARNINGS AND GENERAL NOTES
UPPER**



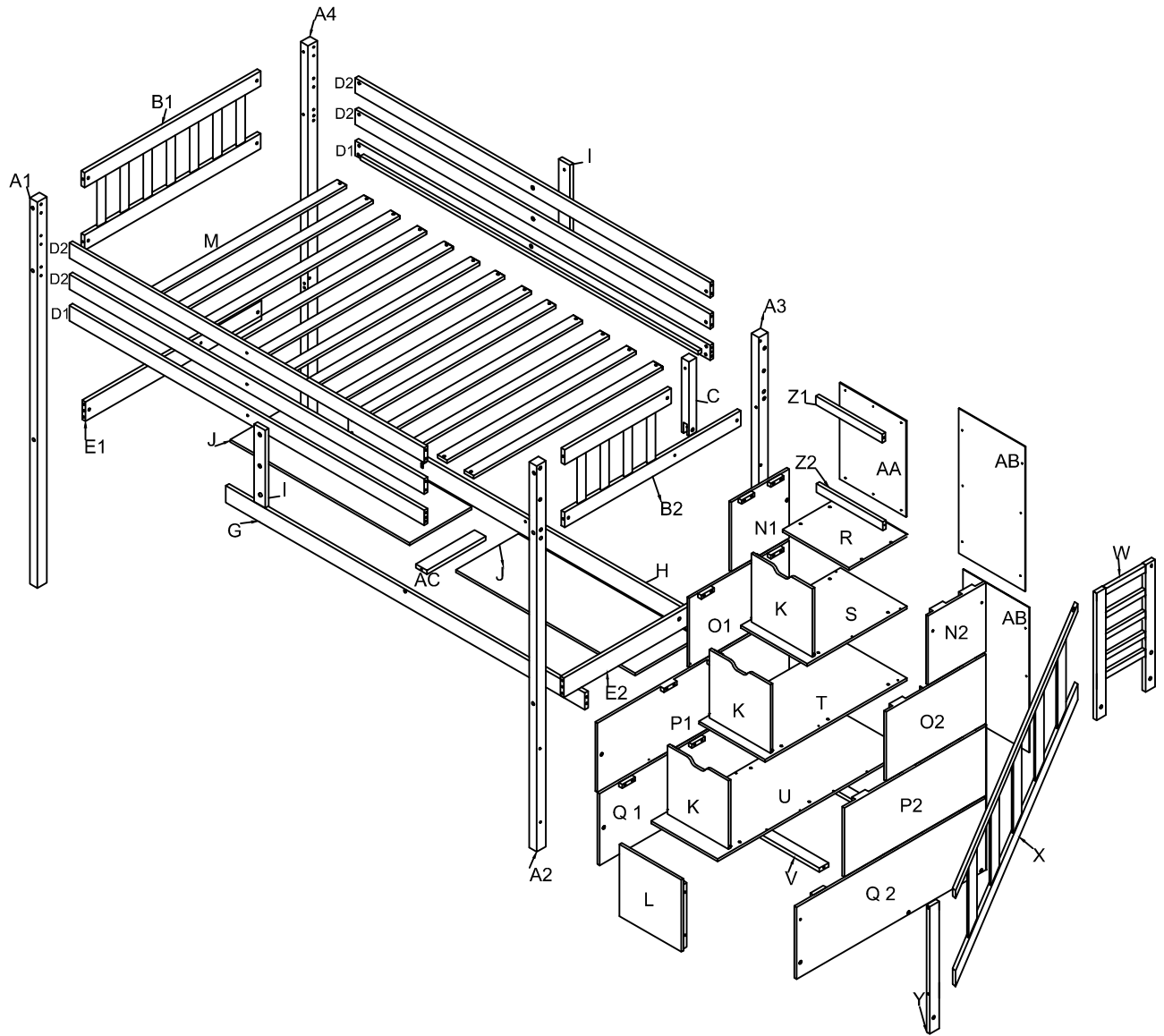

1. Follow the information on the warnings on the bunk bed end structure and on the carton. Do not remove the warning label from the bed
2. Always use the recommended size mattress on mattress support, or both, to help prevent the likelihood of entrapment or falls
3. Do not allow children under 6 years of age to use the upper bunk
4. Periodically check and ensure the guardrail, ladder and other components are in their proper position, free from damage, and all connectors are tight
5. Do not allow horseplay on or under beds.
6. Always prohibit jumping on the bed
7. Prohibit more than one person on upper bunk.
8. Always use the ladder for entering and leaving the upper bunk.
9. Do not use substitute parts. Contact the manufacturer or dealer for replacement parts.
10. Use of a night-light may provide added safety precaution for a child using the upper bunk.
11. Always use guardrails on both long sides of the upper bunk.
If the bunk bed will be placed next to a wall, the guardrail that runs the full length of the bed should be placed against the wall to prevent entrapment between the bed and the wall.
12. The use of water or sleep flotation mattresses is prohibited
13. **STRANGULATION HAZARD**-Never attach or hang items to any part of the bunk bed that are not designed for use with the bed, for example, but not limited to, hook, belts and jump ropes.
14. Keep these instructions for future reference.
15. We recommend assembling your bunk bed on the shipping carton to protect your floor or carpet.
16. Be certain all staples are out of the box before beginning assembly on the shipping carton.
17. **USE ONLY MATTRESSES WHICH ARE AS THE TABLE BELOW ON UPPER AND ON**

Bed type	Length	Width	Thickness
Twin Standard	74" – 75"	37 1/2" - 38 1/2"	6" max

18. **SURFACE OF MATTRESS MUST BE AT LEAST 5" (127MM) BELOW THE UPPER EDGE OF GUARDRAILS.**
19. Replacement Parts, including additional guardrails, may be obtained from any of our (GIGACLOUD TECHNOLOGY (USA) INC) dealers ;

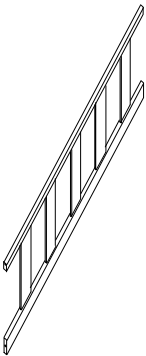
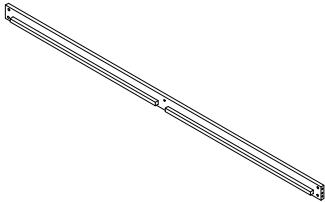
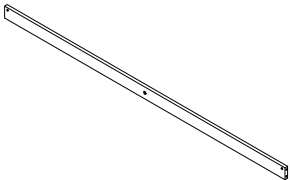
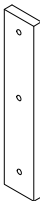
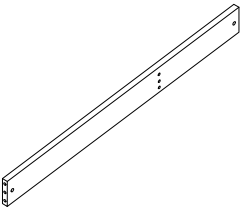
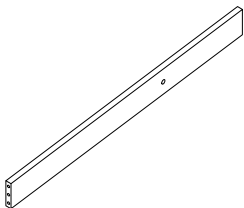
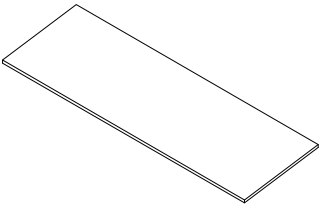
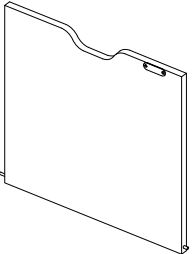
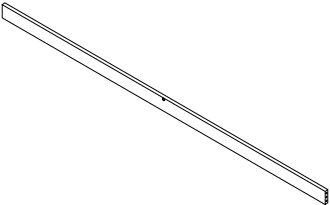
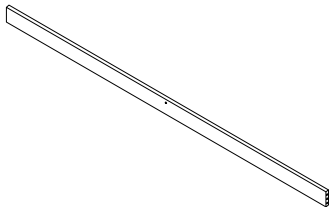
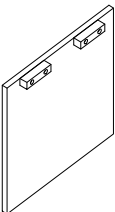

BOX 1: WF287260

<p>A1</p>  <p>Front leg - left (1pcs)</p>	<p>A2</p>  <p>Front leg - right (1pcs)</p>	<p>A3</p>  <p>Back leg - right (1pcs)</p>	<p>A4</p>  <p>Back leg - left (1pcs)</p>
<p>X</p>  <p>side guardrail sets - 1 pcs</p>	<p>D1</p>  <p>Back & front rails - (2pcs)</p>	<p>D2</p>  <p>Back & front guardrail - (4 pcs)</p>	<p>I</p>  <p>Support rails - top (2 pcs)</p>
<p>E1</p>  <p>Side rail table - left (1pcs)</p>	<p>E2</p>  <p>Side rail table - right (1pcs)</p>	<p>J</p>  <p>tabletop - (2 pcs)</p>	<p>K</p>  <p>front drawers - 3 PCS</p>
<p>G</p>  <p>front rail table - (1pcs)</p>	<p>H</p>  <p>back rail table - (1pcs)</p>	<p>N1</p>  <p>Side stair 1 - left (1 pcs)</p>	

BOX 1: WF287260

N2

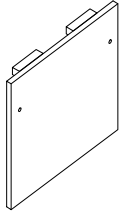

Side stair 1 - right (1 pcs)

O1

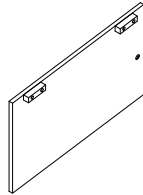

Side stair 2 - left (1 pcs)

O2

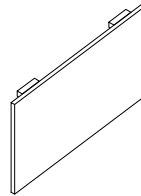

Side stair 2 - right (1 pcs)

P1

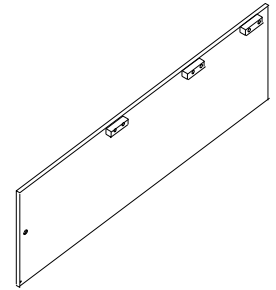

Side stair 3 - left (1 pcs)

P2

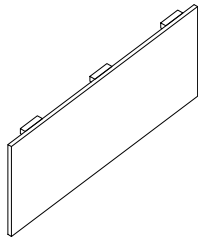

Side stair 3 - right (1 pcs)

V

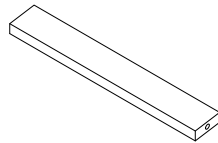

The bar connect side stair 4 - 2 pcs

Y



Pillar guardrail - 1pc

AC

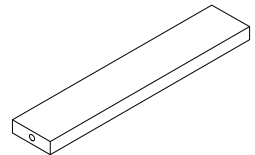

The bar connect rail table - 1 pc

Z1

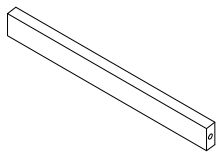

frame bar - back (1 pcs)

Z2

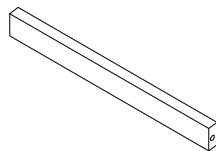

frame bar - back (1 pcs)

W

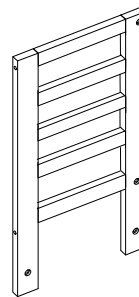

side guardrail sets - 1 pcs

BOX 2: WF287261

Q1

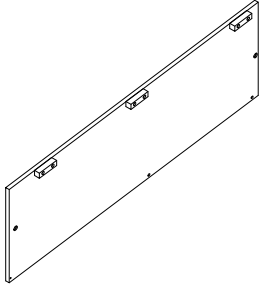

Side stair 4 - left (1 pcs)

Q2

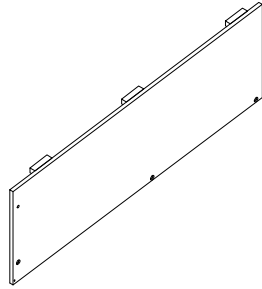

Side stair 4 - right (1 pcs)

L

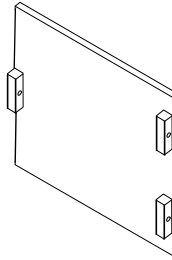

front drawer - 1 PCS

M

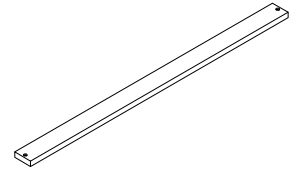

slats - 13 pcs

B1

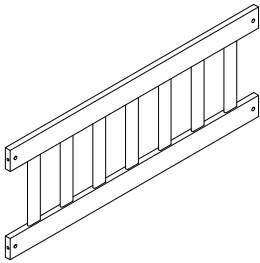

Headboard - left (1pcs)

B2

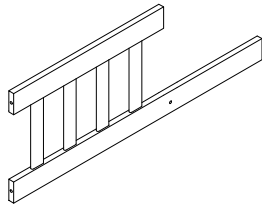

Headboard - right (1pcs)

AA

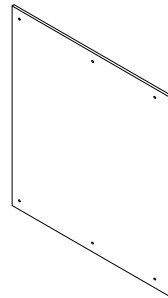

back panel - stair (1 pcs)

AB

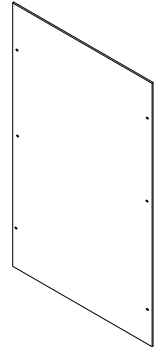

back panel - stair (2 pcs)

U

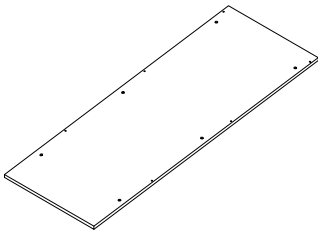

stair surface 4 - 1 pcs

R

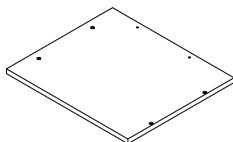

stair surface 1 - 1 pcs

S

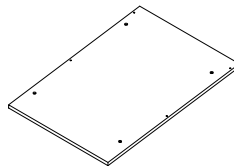

stair surface 2 - 1 pcs

T

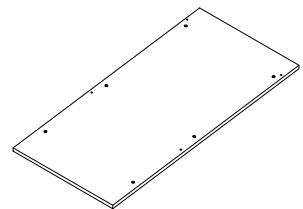







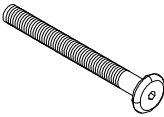

stair surface 3 - 1 pcs

C

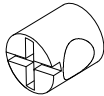
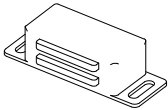
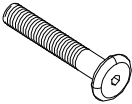

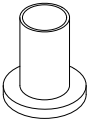
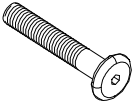
Pillar headboard - left (1pcs)

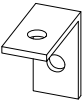
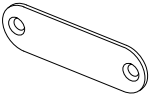
Hardware list : WF287260

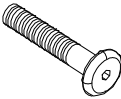
<p>1</p>  <p>1/4" x100mm Hex head bolts - 32 pcs</p>	<p>2</p>  <p>Ø8 x 30 Wood dowel - 31 pcs</p>	<p>3</p>  <p>m4 x 25 Wood screws - 62 pcs</p>	<p>4</p>  <p>1/4" x 13 mm Horizontal-hole bolt 32 pcs</p>
<p>5</p>  <p>magnet - 3 pcs</p>	<p>6</p>  <p>1/4" x 25 mm Hex head bolts - 15 pcs</p>	<p>7</p>  <p>m3.5 x 10 Wood screws 36 pcs</p>	<p>8</p>  <p>Allen key - 1 PC</p>
<p>9</p>  <p>Canopy head though - 9 pcs</p>	<p>10</p>  <p>1/4" x 60 mm Hex head bolts - 7 pcs</p>	<p>11</p>  <p>m4 x 15 Wood screws 20 pcs</p>	<p>12</p>  <p>L - bracket 12 PCS</p>
<p>13</p>  <p>magnet - 3 pcs</p>	<p>14</p>  <p>m3 x 17 steel dowel 6 pcs</p>	<p>15</p>  <p>1/4" x 20 mm Hex head bolts - 10 pcs</p>	

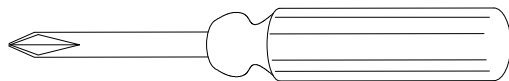

Assemble tools required (Not included)

Step 1

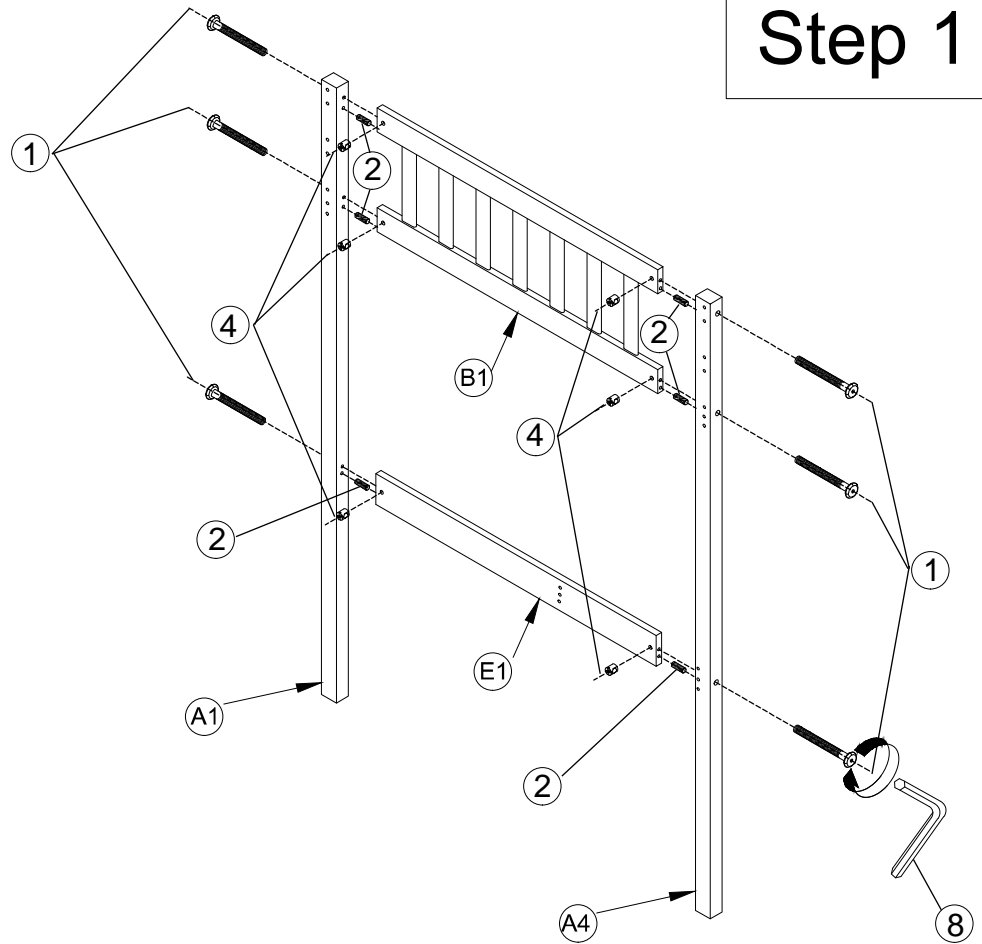

2



Ø8 x 30
Wood dowel - 6 pcs

4



1/4" x 13 mm
Horizontal-hole bolt 6 pcs

1



1/4" x 100 mm
Hex head bolts - 6 pcs

Step 2

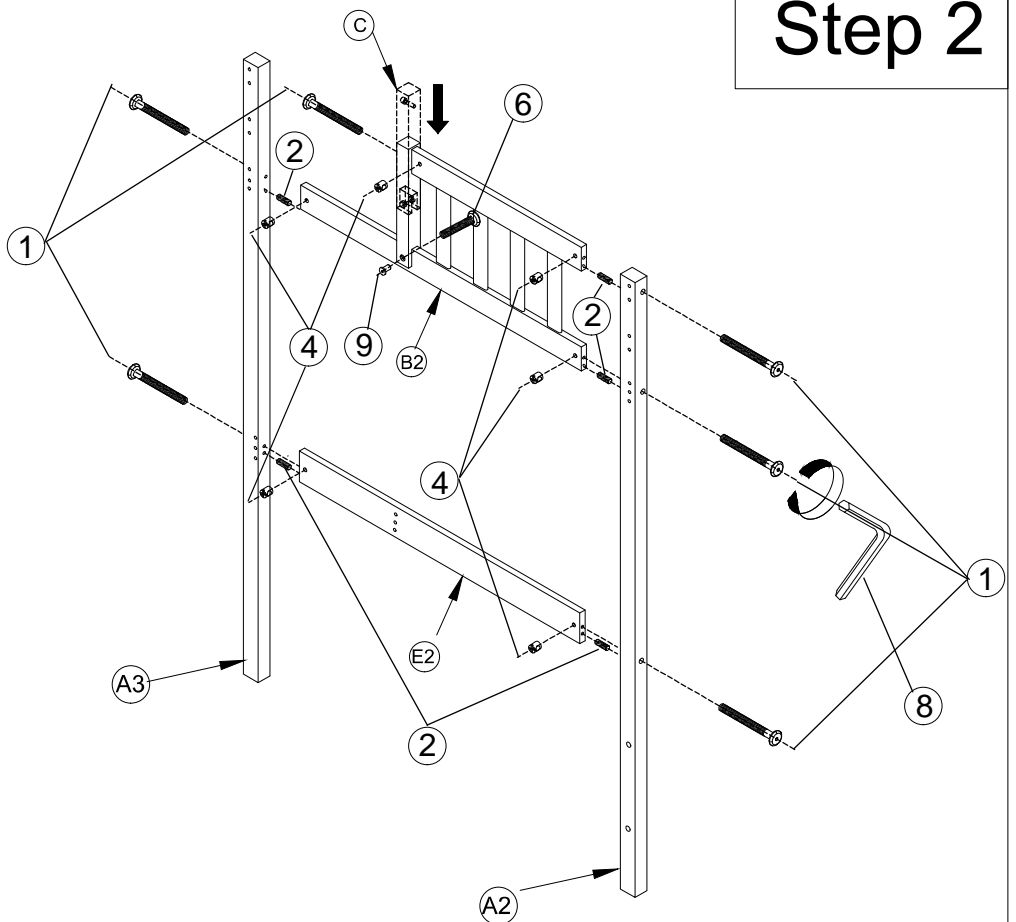

2



Ø8 x 30
Wood dowel - 5 pcs

4



1/4" x 13 mm
Horizontal-hole bolt 6 pcs

9



Canopy head though
- 1 pcs

1



1/4" x 100 mm
Hex head bolts - 6 pcs

6





1/4" x 25 mm
Hex head bolts - 1 pcs

front drawer - 3 sets

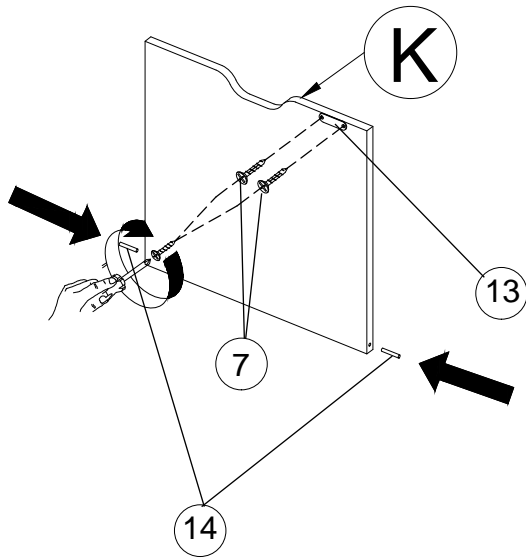
Step 3

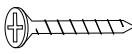

<p>7</p>  <p>m3.5 x 10 Wood screws 6 pcs</p>	<p>14</p>  <p>m3 x 17 steel dowel 6 pcs</p>	<p>13</p>  <p>magnet - 3 pcs</p>
---	--	---

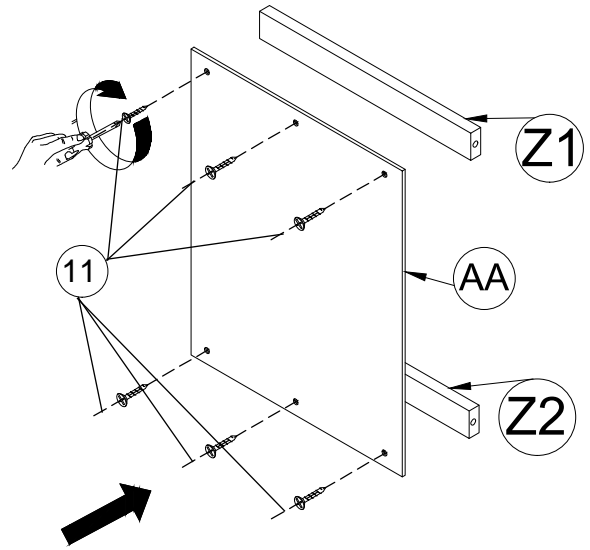

Step 4

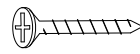

<p>11</p>  <p>m4 x 15 Wood screws 6 pcs</p>
--

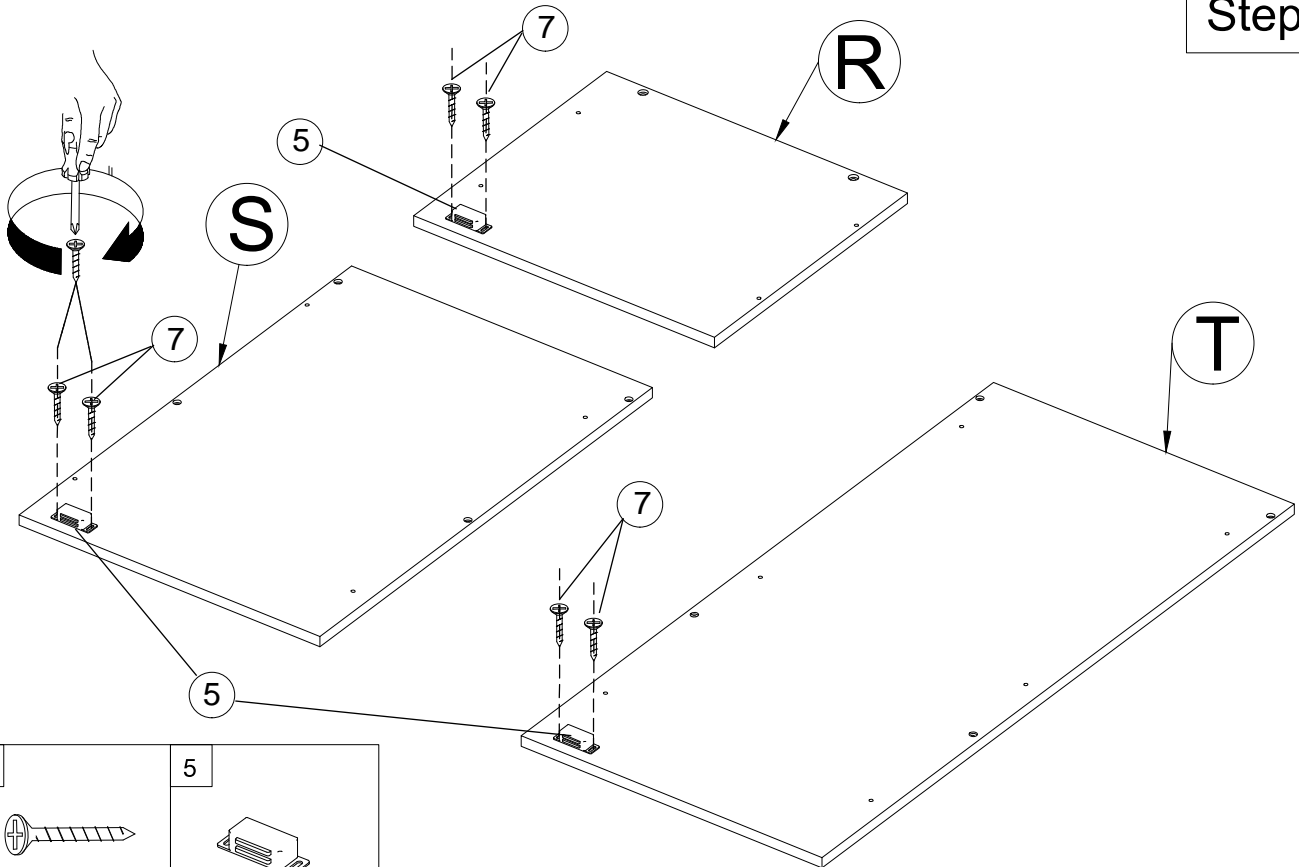
Step 5

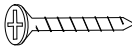

<p>7</p>  <p>m3.5 x 10 Wood screws 6 pcs</p>	<p>5</p>  <p>magnet - 3 pcs</p>
---	--

Step 6

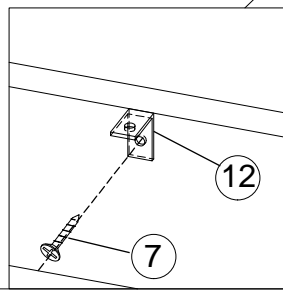
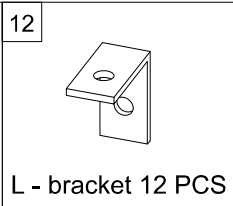
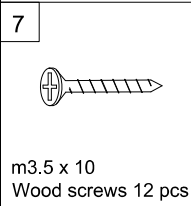
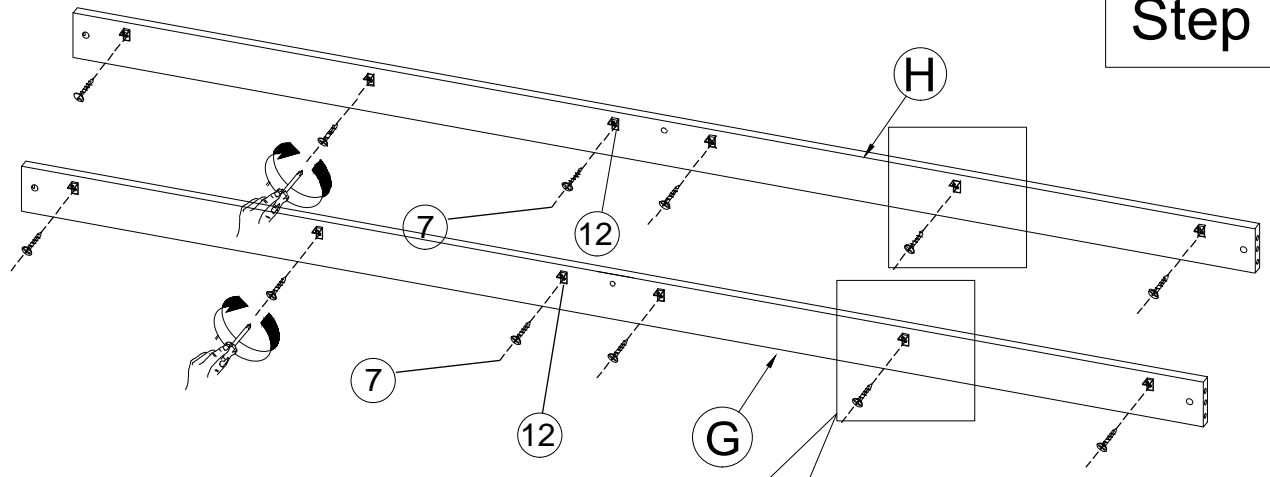

Step 7

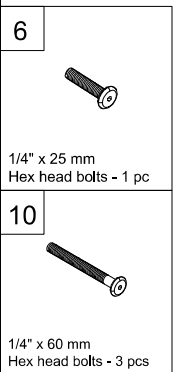
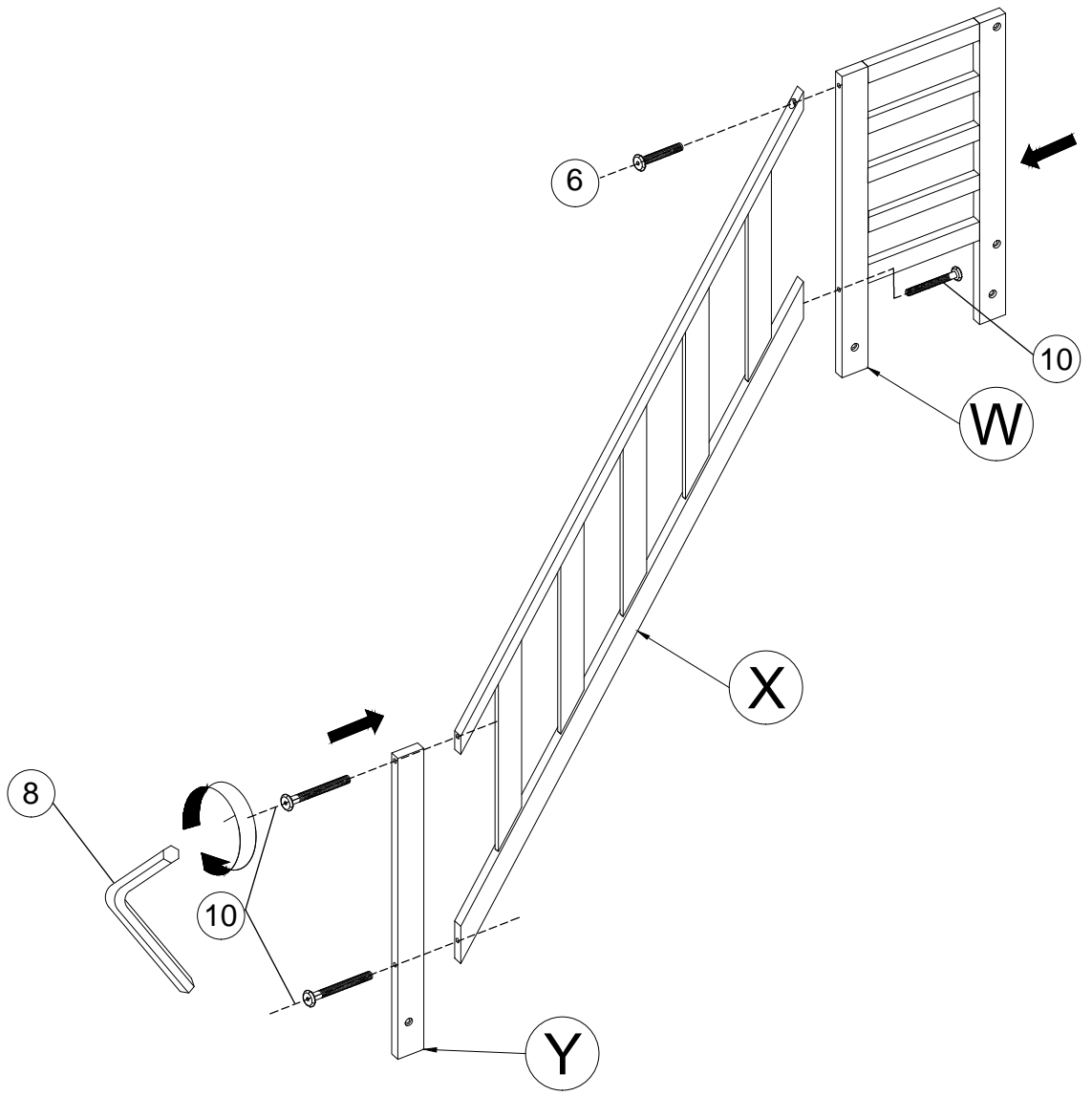

Step 8

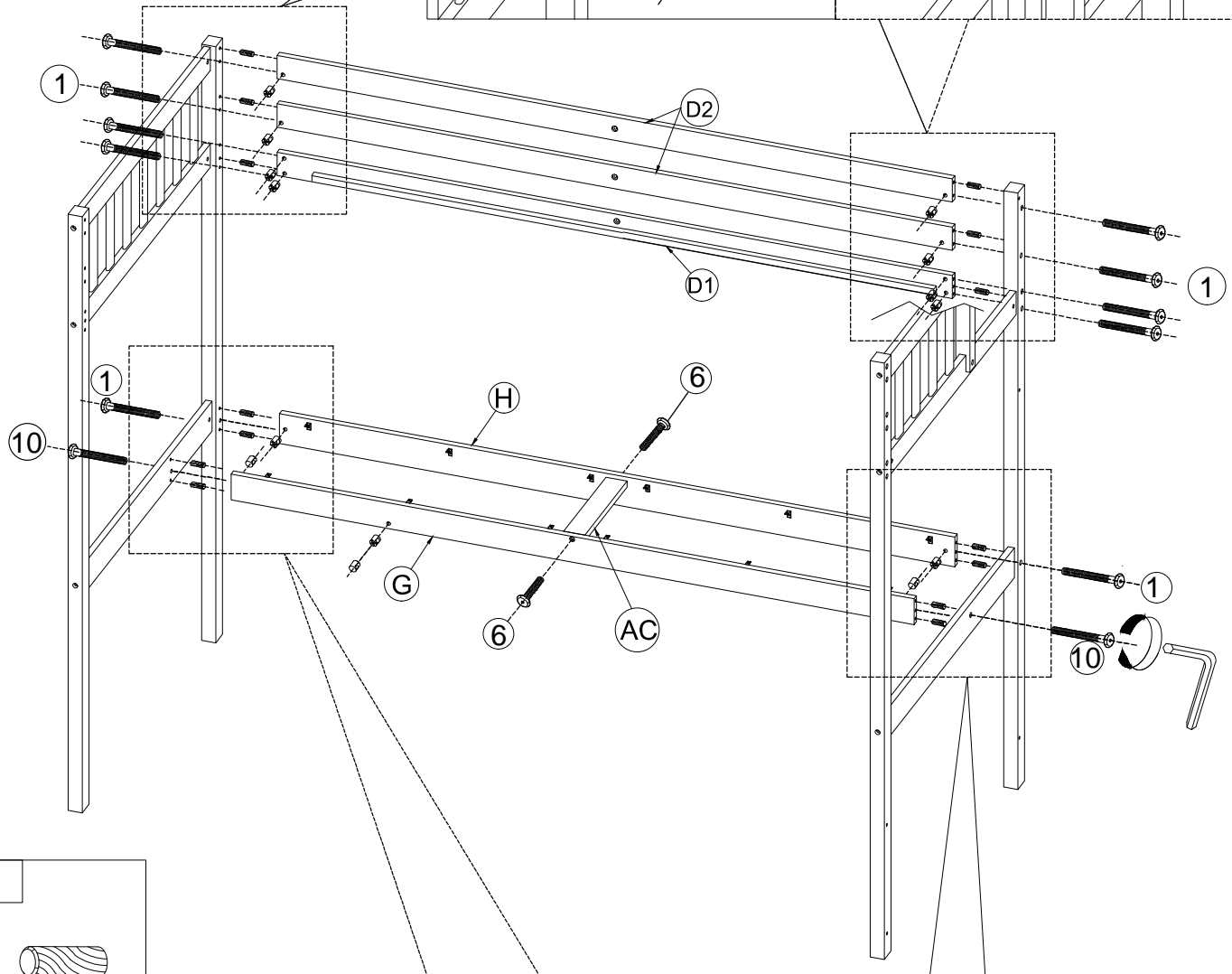
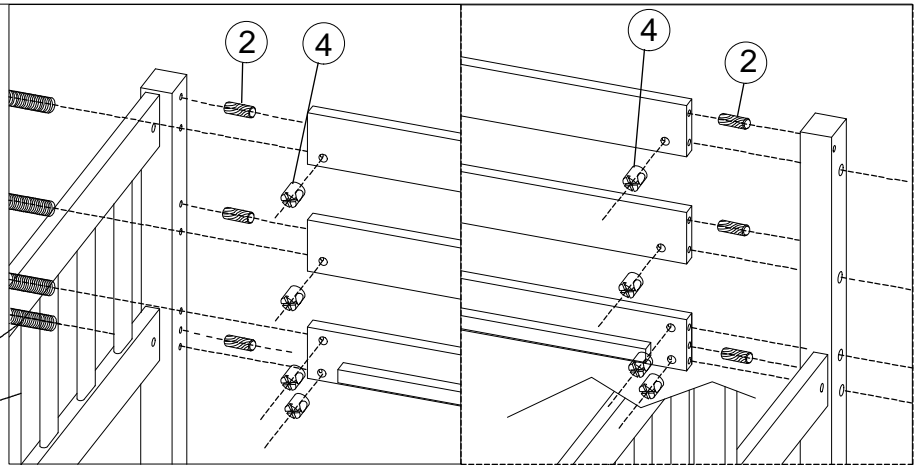

2



Ø8 x 30
Wood dowel - 4 pcs

4



1/4" x 13 mm
Horizontal-hole bolt - 12 pcs

10



1/4" x 60 mm
Hex head bolts - 2 pcs

1



1/4" x 100 mm
Hex head bolts - 10 pcs

6



1/4" x 25 mm
Hex head bolts - 2 pcs

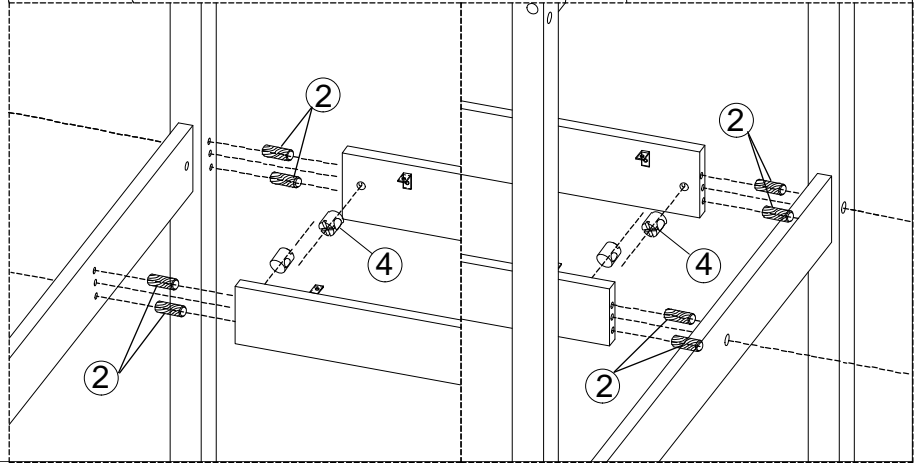

Step 9

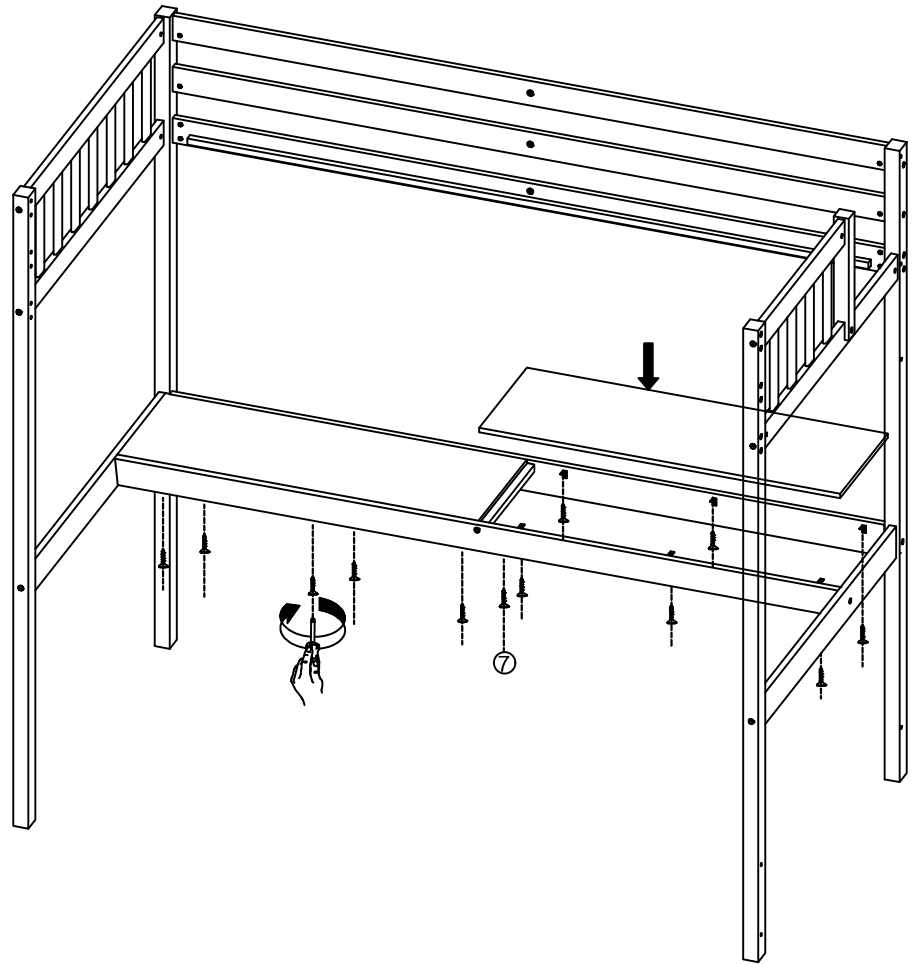

7



m3.5 x 10
Wood screws - 12 pcs

Step 10

Balcony don't tighten these yet.
Leave them a bit loose to make
fitting the lower side rail more
easily

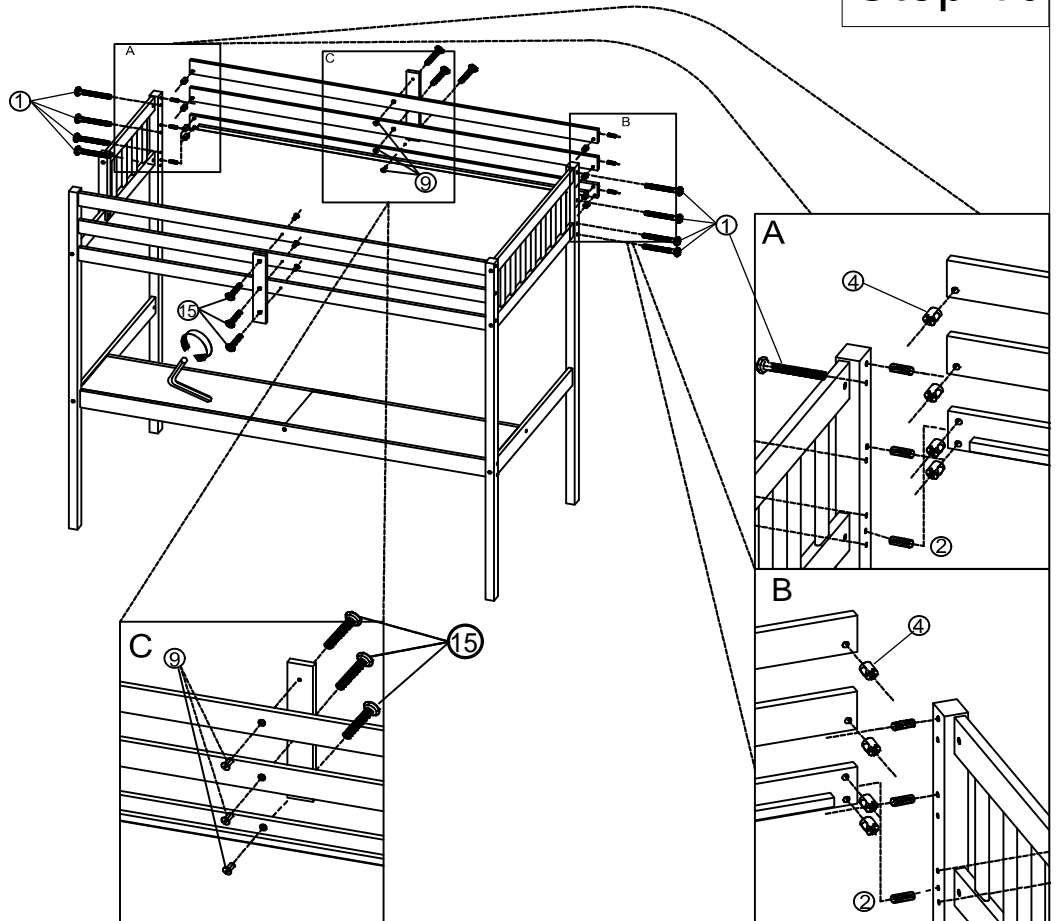

9



Canopy head through
- 6 pcs

15



1/4" x 20 mm
Hex head bolts - 6 pcs

2



Ø8 x 30
Wood dowel - 6 pcs

1



4

1/4" x 13 mm
Horizontal-hole bolt - 8 pcs

1/4" x 100mm
Hex head bolts - 8 pcs

Step 11

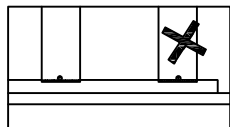
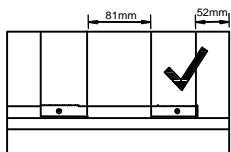
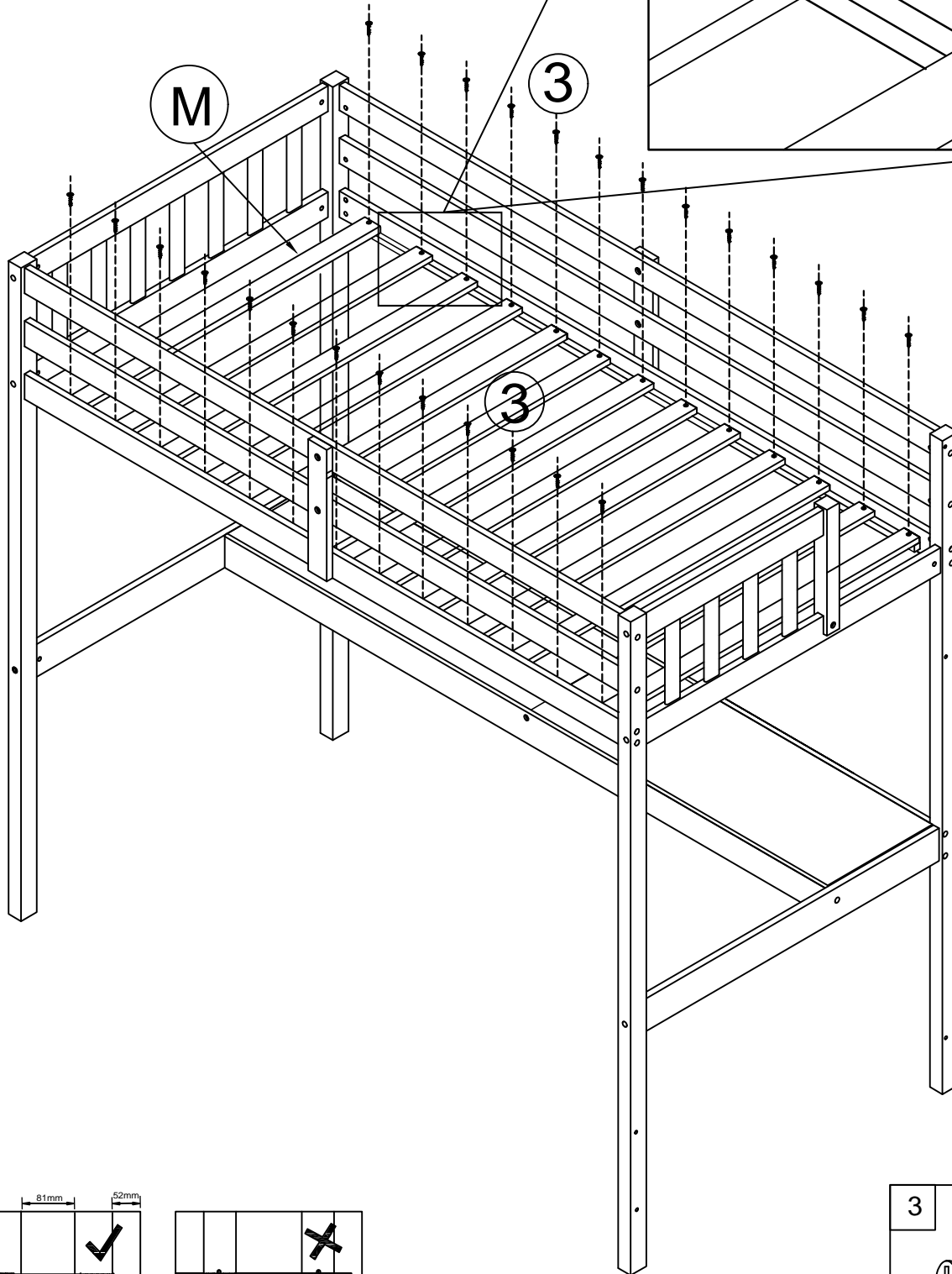

Note: Do not lock the screws of the bed slats to the outermost edge of the bed slats, you need to leave a certain space at the edges, otherwise it will cause the board to break

3

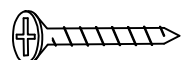

m4 x 25
Wood screws 26 pcs

Step 12

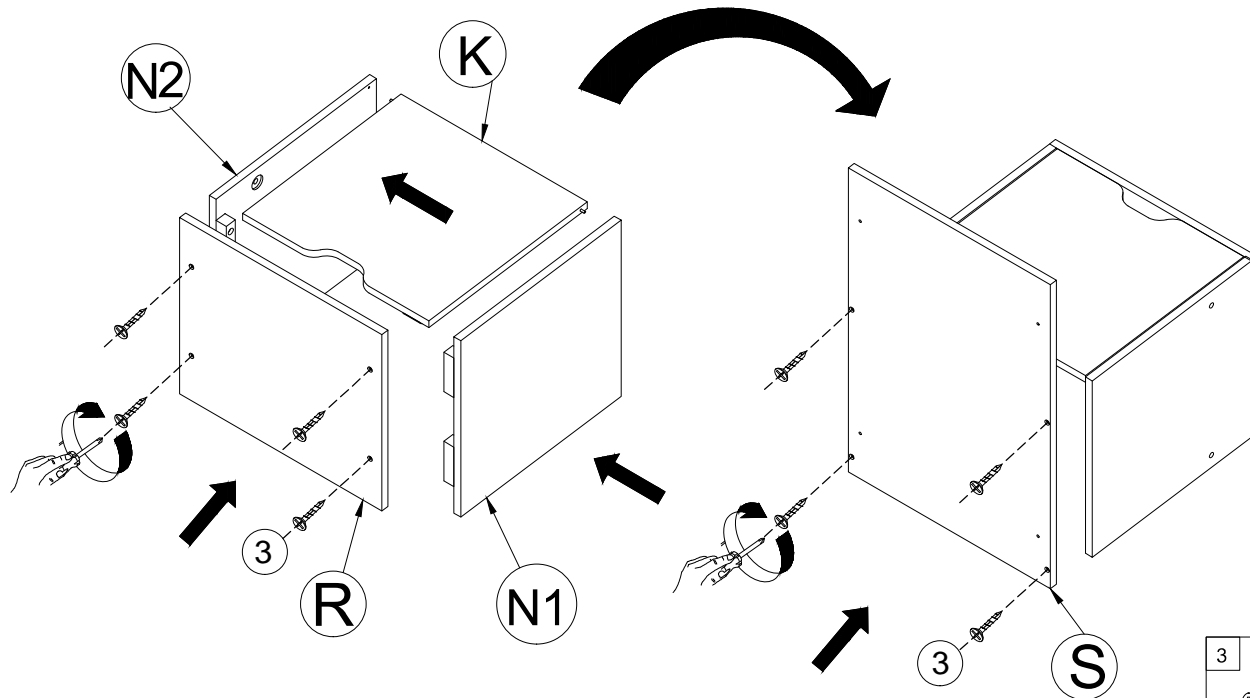

3

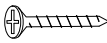

m4 x 25
Wood screws 8 pcs

Step 13

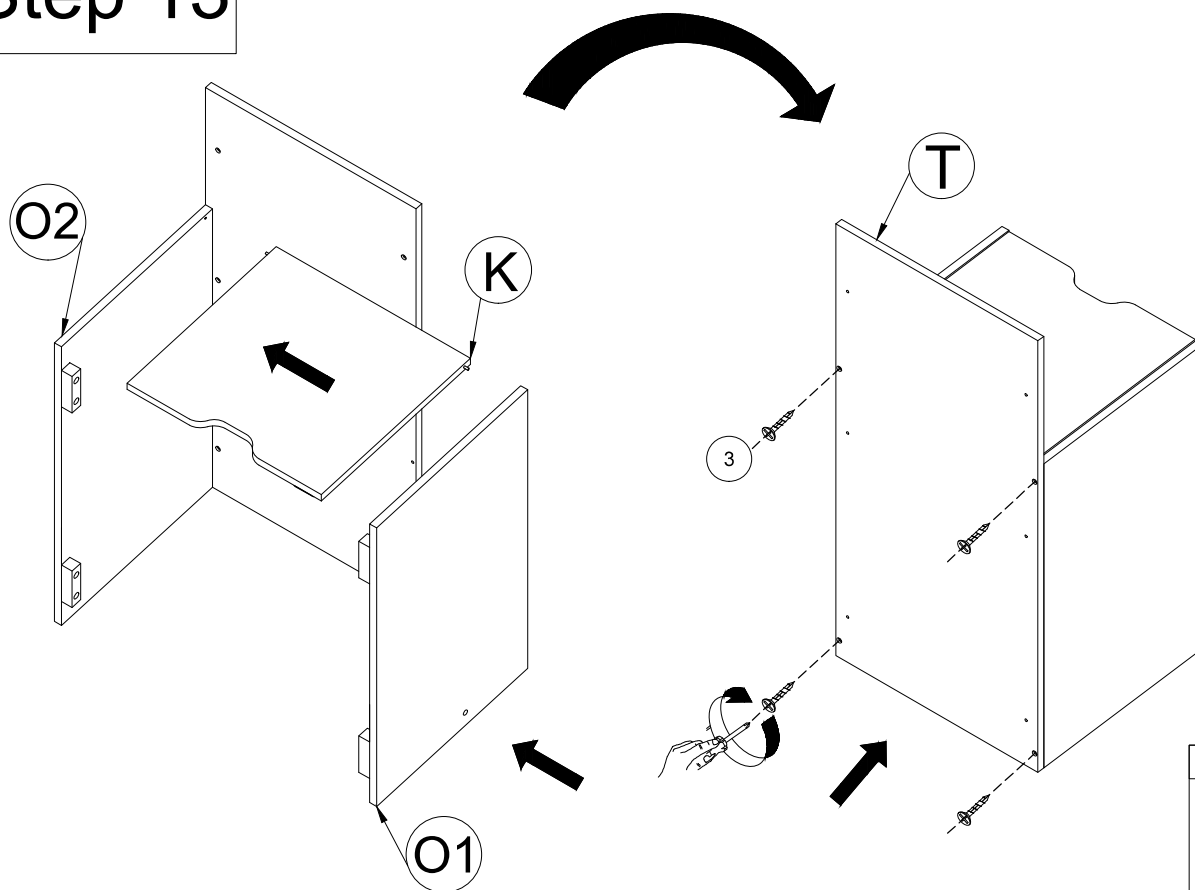

3

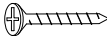

m4 x 25
Wood screws 4 pcs

Step 14

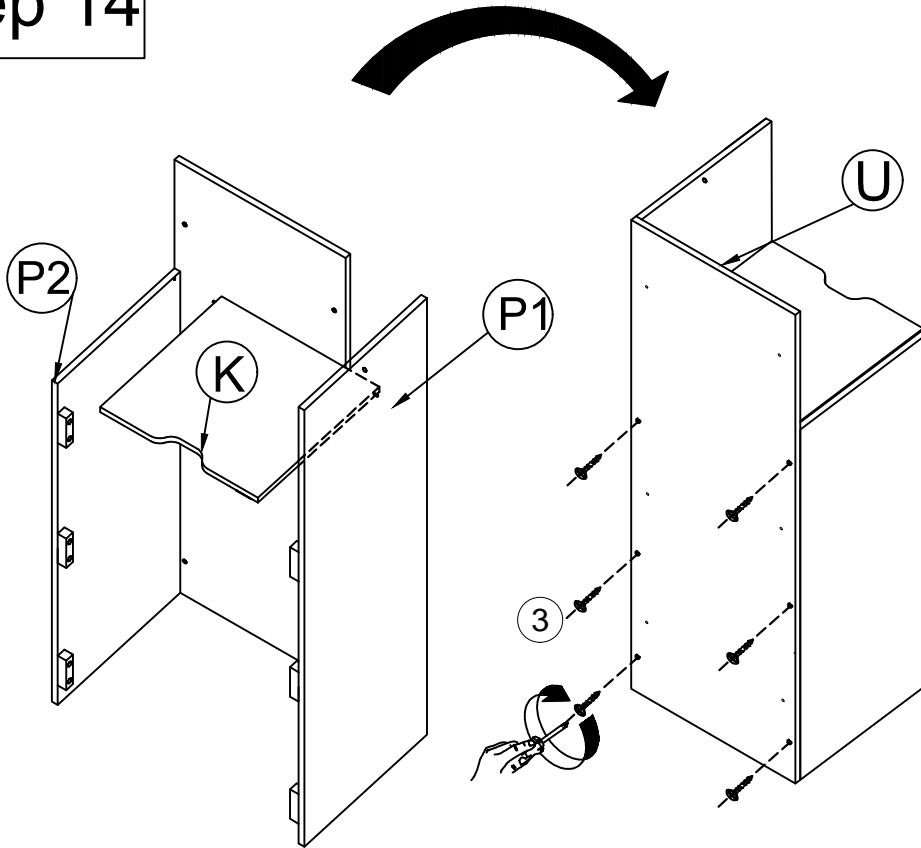

3

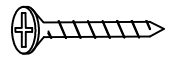

m4 x 25
Wood screws 6 pcs

Step 15

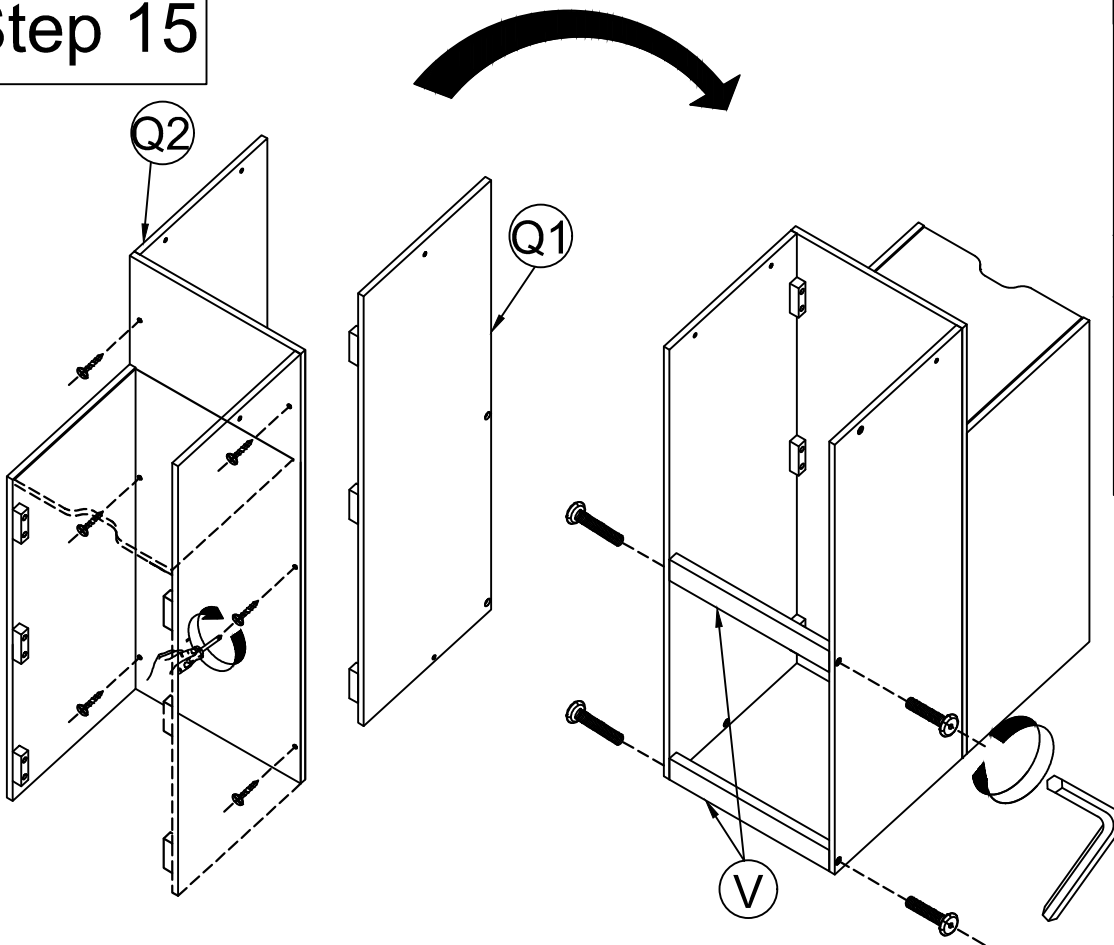

3

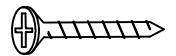

m4 x 25
Wood screws 6 pcs

6



1/4" x 25 mm
Hex head bolts - 4 pcs

Step 16

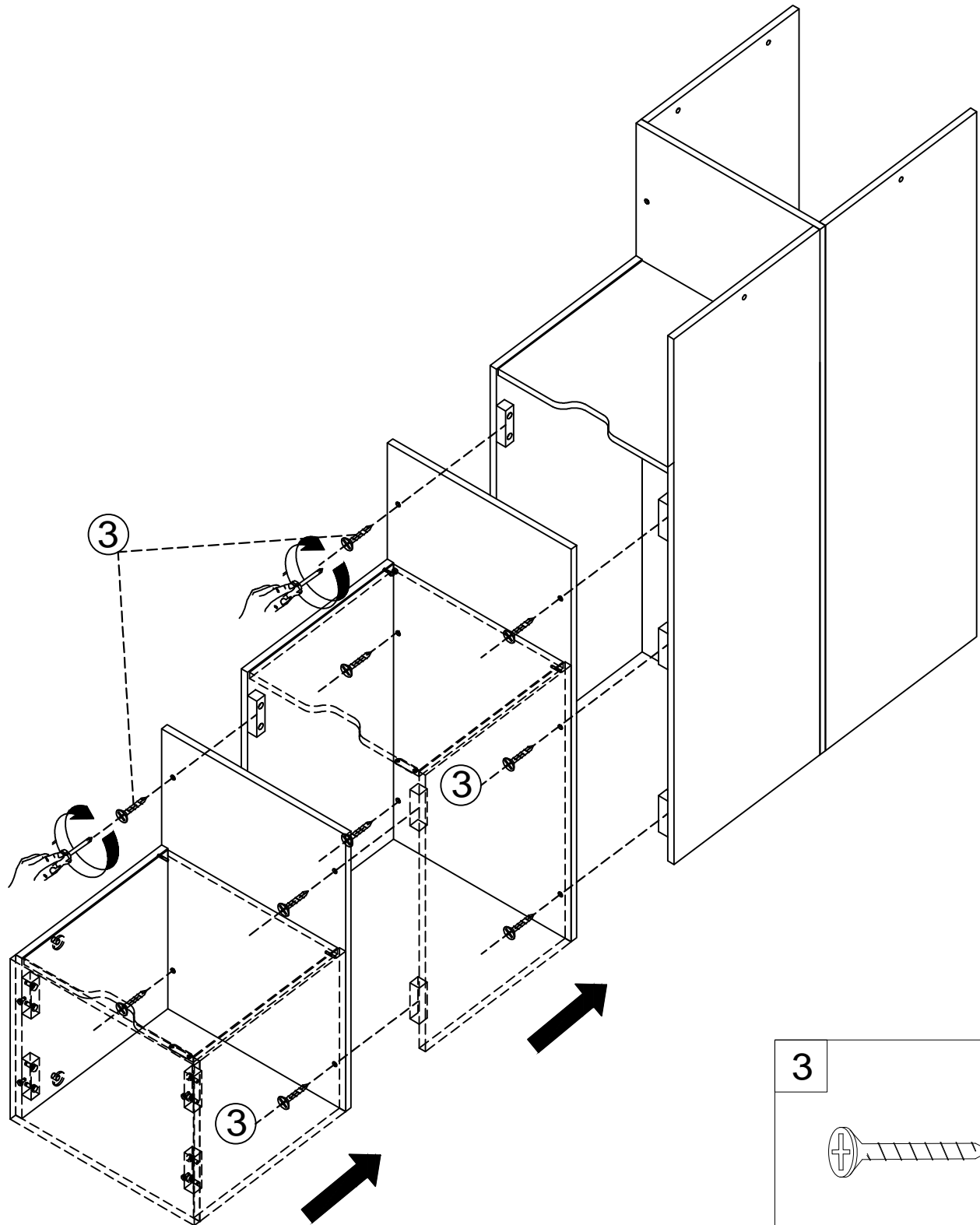

3

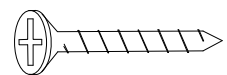

m4 x 25
Wood screws 10 pcs

Step 17

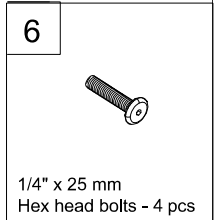
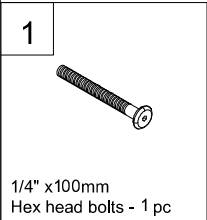
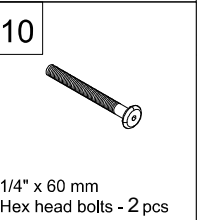
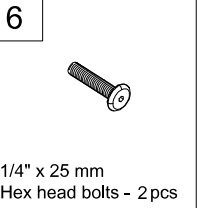
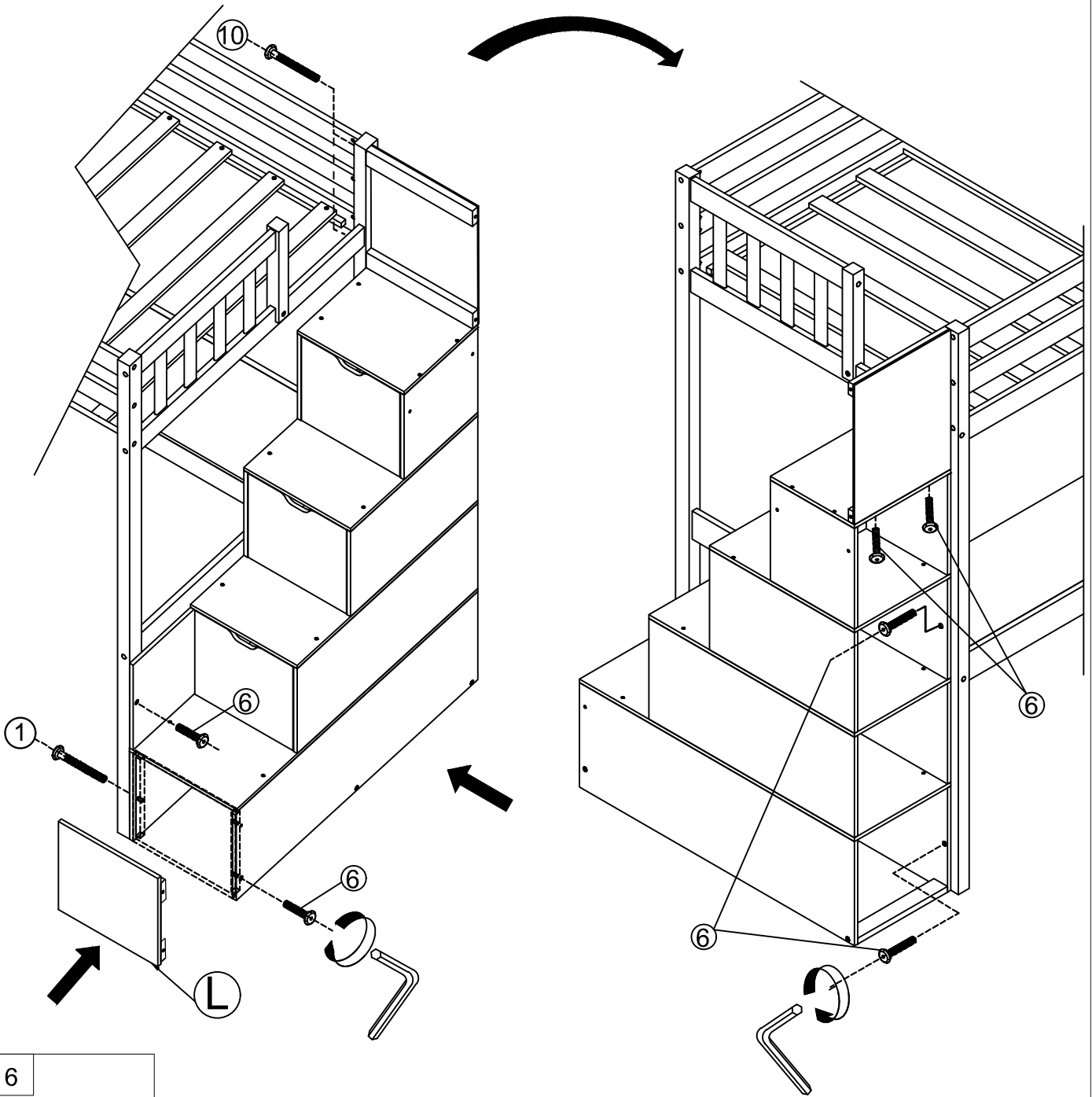

Step 18

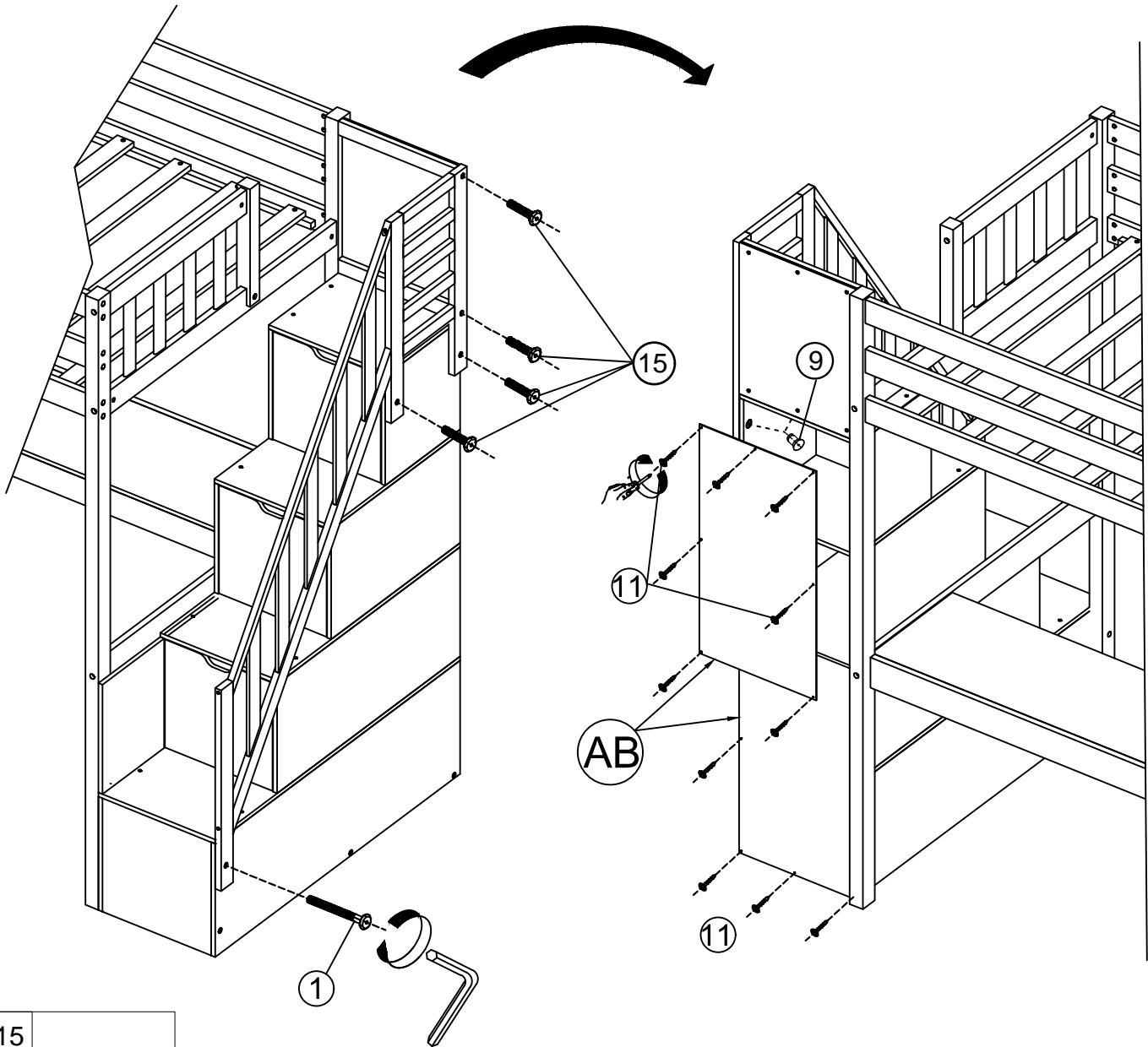

15



1/4" x 20 mm
Hex head bolts - 4 pcs

1

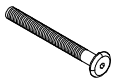

1/4" x 100mm
Hex head bolts - 1 pc

9

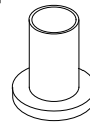

Canopy head though
- 2 pcs

11

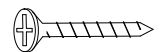

m4 x 15
Wood screws 14 pcs