

HUSKY



CANADA

QUICK START GUIDE
GUIDE DE DÉMARRAGE RAPIDE
HUSKY FLEX

DOC-610-HU REV03



Intertek



Like us | *Aimez-nous:*
www.facebook.com/huskyvac

2000868

Conforms to / *Conforme à:*

UL Std. 1017

Certified to / *Certifié selon:*

CAN/CSA Std. C22.2 No. 243-10

VACUUM UNIT INSTALLATION WITH EXISTING PIPING INSTALLATION DE L'ASPIRATEUR AVEC TUYAUTERIE EXISTANTE

RECOMMENDED TOOLS (Not included)
OUTILS RECOMMANDÉS (Non fournis)

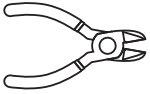

Cutting Pliers
Pince coupante



Slotted Screwdriver
Tournevis plat



Drill
Perceuse



Tape Measure
Ruban à mesurer



Pliers
Pince à bout plat



Utility Knife
Couteau utilitaire

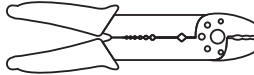

Stripping/Crimping Pliers
Pince à dénuder et sertir



Pencil
Crayon

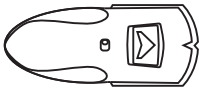

Stud Sensor
Déecteur de montants

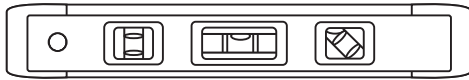

Level
Niveau

1 RECOMMENDED WALL BRACKET INSTALLATION | INSTALLATION RECOMMANDÉE DU SUPPORT MURAL



**WARNING! 30 cm (12 in.)
clearance required on all
sides of Vacuum Unit.**

**ATTENTION! Dégagement de
30 cm (12 po) requis de tous
les côtés de l'aspirateur.**

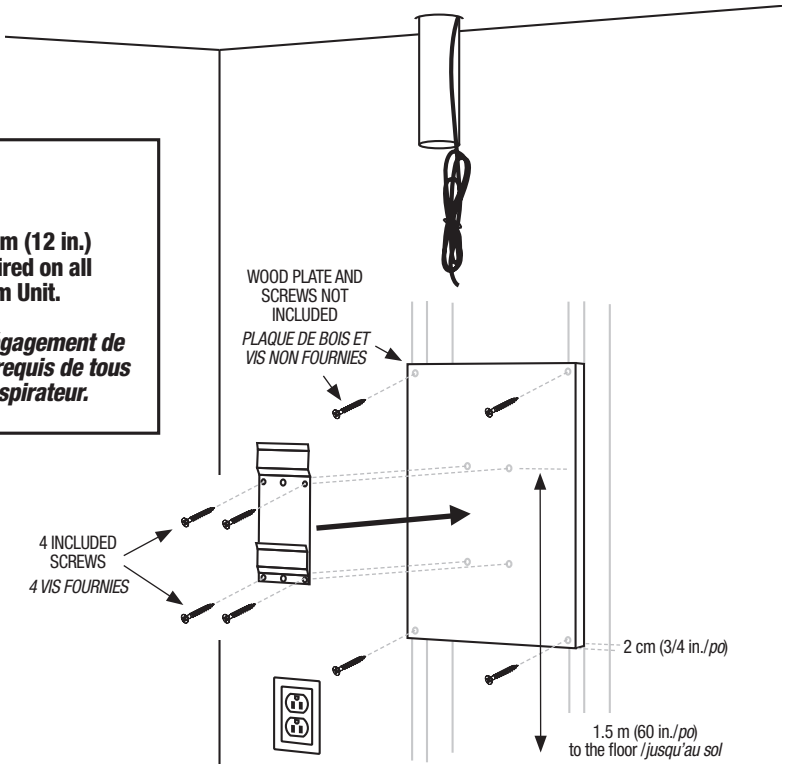

2 VACUUM UNIT INSTALLATION | INSTALLATION DE L'ASPIRATEUR

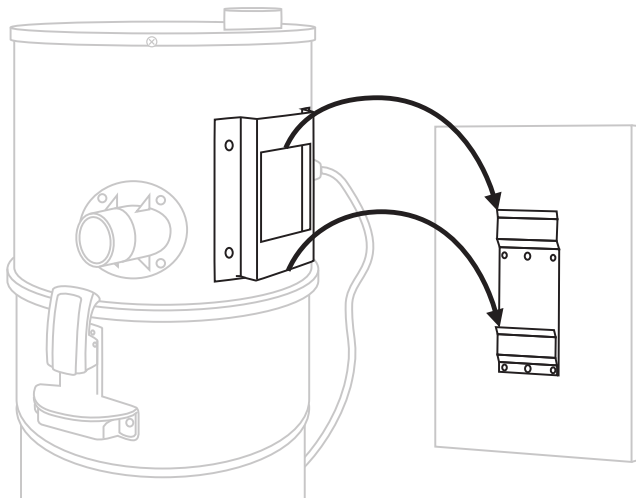

3 AIR INTAKE CONNECTION | RACCORDEMENT DE L'ENTRÉE D'AIR

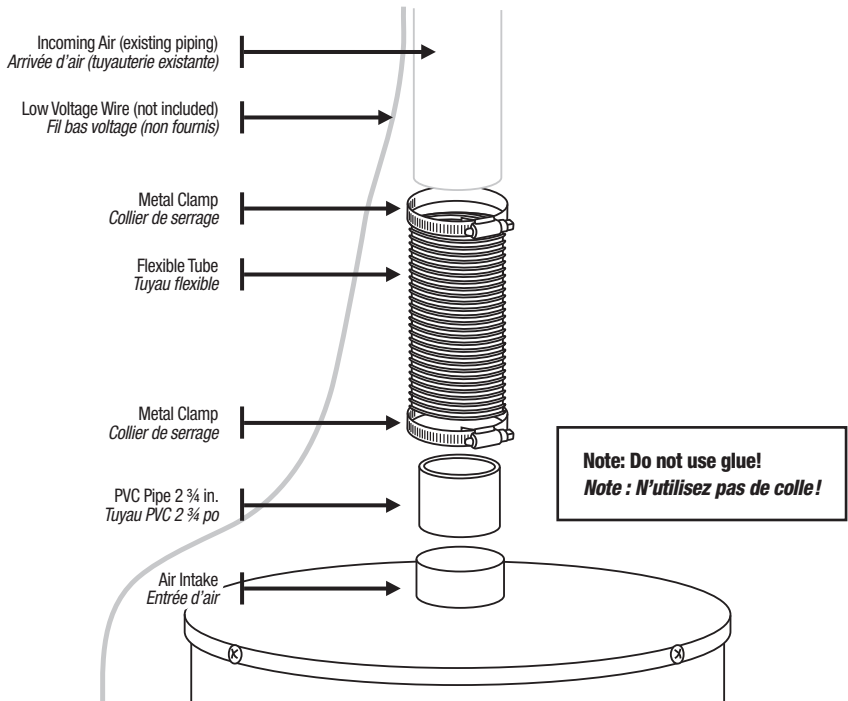

④ LOW VOLTAGE WIRE CONNECTION | RACCORDEMENT DES FILS BAS VOLTAGE

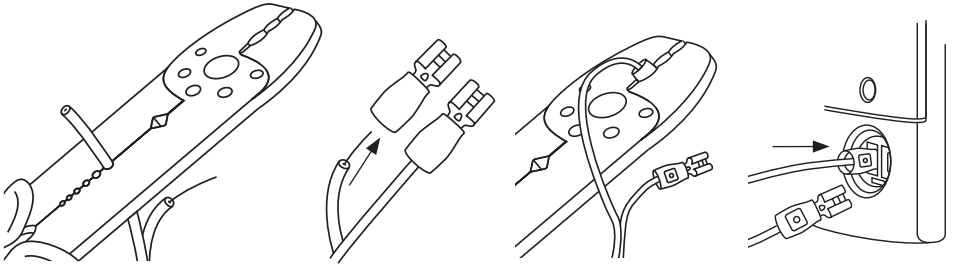

⑤ VACUUM UNIT CONNECTION | BRANCHEMENT DE L'ASPIRATEUR

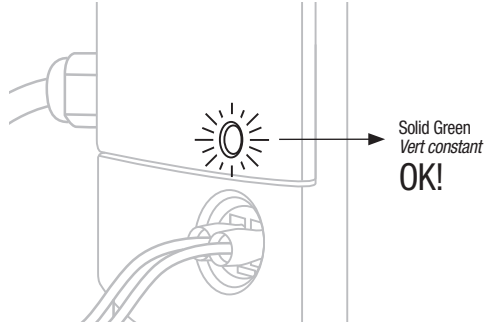
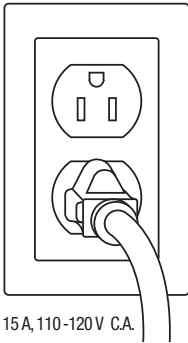

YOUR CENTRAL VACUUM IS INSTALLED!
VOTRE ASPIRATEUR CENTRAL EST INSTALLÉ!

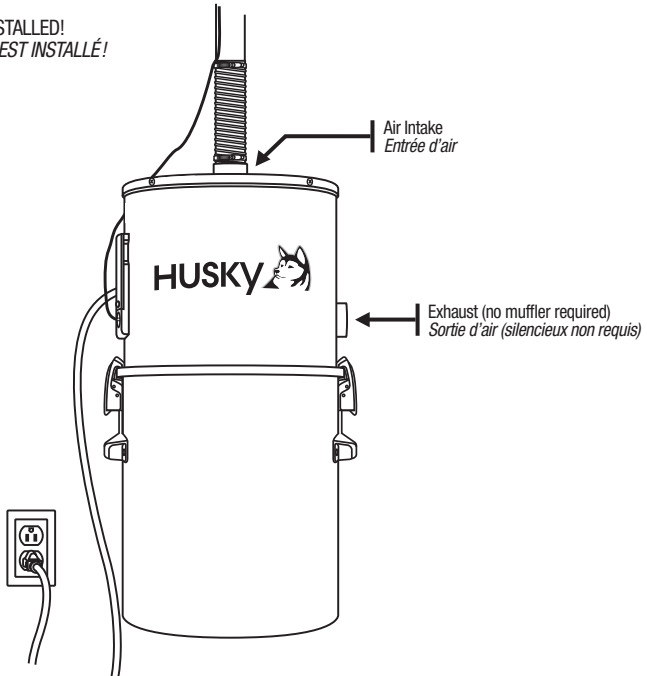



WARNING! The Permanent Filter must ALWAYS be in place when the system is in use, even when the Filtration Bag is installed.

ATTENTION! Le filtre permanent doit TOUJOURS être en place lors de l'utilisation du système, même lorsque le sac de filtration est installé.

1

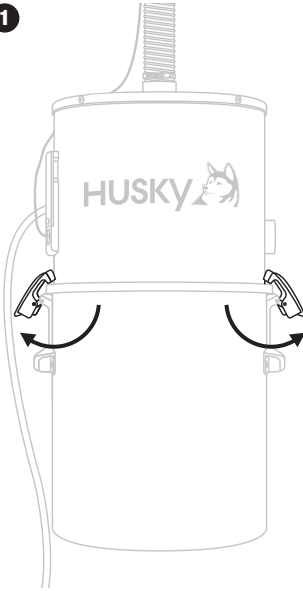

3

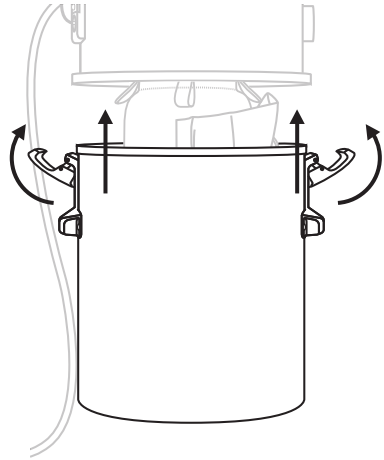

2

Elastic Band
Bande élastique
Metal Ridge
Rebord de métal
Permanent Filter
Filtre permanent

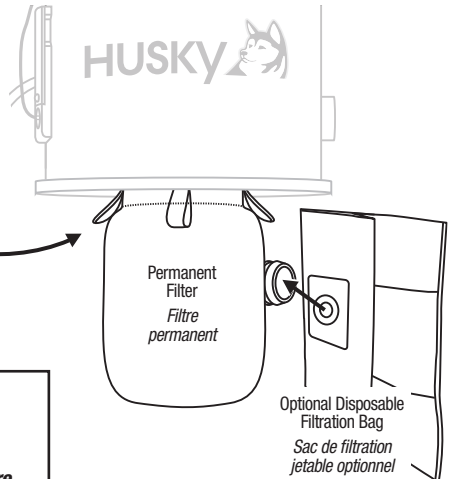
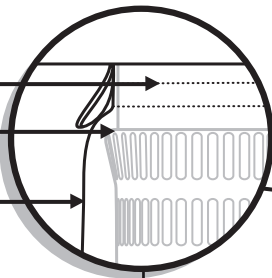

IMPORTANT: The Elastic Band of the Permanent Filter must go all the way over the Metal Ridge.

IMPORTANT : La bande élastique du filtre permanent doit être complètement enfilée par-dessus le rebord de métal.

CONTENTS | CONTENU

1

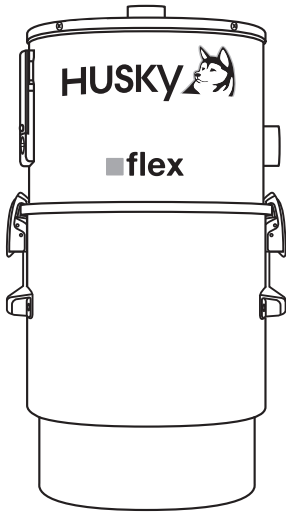

2

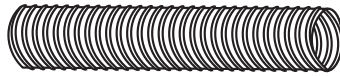

3

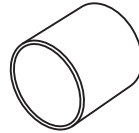

4

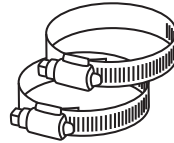

5

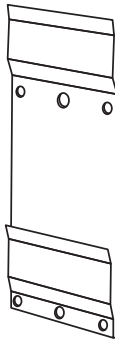

6

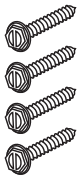

7



8

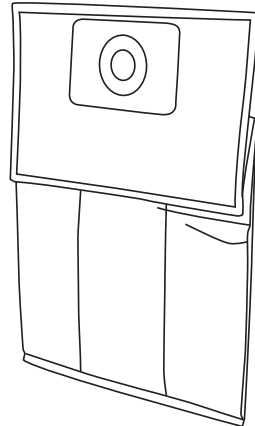

Wall Bracket attached
to back of Vacuum Unit
Support mural attaché
à l'arrière de l'aspirateur

Item	Code	Item	Code
1 Vacuum Unit Aspirateur	FLX-260I-NA-EH	5 Wall Bracket Support mural	SUP-MURAL-T1
2 Flexible Tube 2 ft. Tuyau flexible 2 pi	ACC-0660-2	6 Wood Screw (4x) Vis à bois (4x)	PAD-PAD-83
3 PVC Pipe 2 3/4 in. Tuyau PVC 2 3/4 po	TUY-297	7 Low Voltage Connector (2x) Connecteur bas voltage (2x)	PAD-PAD-55
4 Metal Clamp (2x) Collier de serrage (2x)	PCH-313	8 Filtration Bag Sac de filtration	FILTRE-189-1

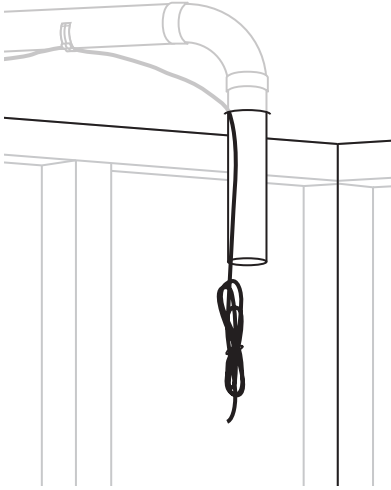

If a PVC piping network for central vacuum is already installed in your home: Follow instructions inside this guide to connect to the existing piping in 5 easy steps.

Si un réseau de tuyauterie PVC pour aspirateur central est déjà installé dans votre maison : suivez les instructions à l'intérieur de ce guide pour raccorder à la tuyauterie existante en 5 étapes faciles.

If no PVC piping network for central vacuum has been installed in your home:

Si aucun réseau de tuyauterie PVC pour aspirateur central n'a été installé dans votre maison :



A RECOMMENDED: Book your installation with a central vacuum installer or contact us for any additional information.

RECOMMANDÉ : prenez rendez-vous avec un installateur d'aspirateurs centraux ou contactez-nous pour de plus amples informations.

1 800-361-3965

info@nuera-air.com



OR / OU

B Download our complete installation manual to install the piping network yourself.

Téléchargez notre manuel d'installation complet pour installer vous-même le réseau de tuyauterie PVC.

www.huskyvac.com



SAFETY INSTRUCTIONS FOR THE INSTALLATION

IMPORTANT : PLEASE REFER TO THE USER MANUAL FOR COMPLETE SAFETY INSTRUCTIONS REGARDING THE USE OF THIS APPLIANCE.



- Do not use with damaged cord or plug.
- Connect to a properly grounded outlet only.
- Do not use an extension cord to plug the unit.
- Do not exhaust air into a wall, a ceiling or concealed space of a building or structure.
- Make sure that the air exhaust and the Vacuum Unit vent holes are not obstructed.

INSTRUCTIONS RELATIVES À LA SÉCURITÉ LORS DE L'INSTALLATION

IMPORTANT : RÉFÉREZ-VOUS AU MANUEL D'UTILISATION POUR CONNAÎTRE L'ENSEMBLE DES CONSIGNES DE SÉCURITÉ EN LIEN AVEC L'UTILISATION DE CET APPAREIL.

- N'utilisez pas le système si le cordon d'alimentation ou la prise électrique sont endommagés.
- Branchez le système à une prise de courant correctement mise à la terre.
- N'utilisez pas de rallonge pour relier le système à une source d'alimentation.
- L'évacuation d'air du système ne peut pas donner directement sur un mur, un plafond ou un espace confiné dans un bâtiment ou une structure.
- Assurez-vous que la sortie d'air et les ouvertures d'aération de l'aspirateur ne sont pas obstruées.



HUSKY 

3695 Desserte des Laurentides (A-15) E
Laval, QC H7L 3H7
CANADA

Toll free | Sans frais: 1-800-361-3965
Tel.: 450-622-9000
info@nuera-air.com
huskyvac.com