

Bosch Remote Controller

For use with Bosch Split-Type Ductless Air Conditioner / Heat Pump



BOSCH

User Manual

Table of Contents

1	Key to symbols and safety instructions	4
1.1	Key to symbols	4
		4
<hr/>		
2	Remote controller specifications	5
<hr/>		
3	Operation of buttons	6
<hr/>		
4	Indicators on LCD	8
<hr/>		
5	How to use the buttons	9
5.1	Auto operation	9
5.2	Cooling /Heating/Fan operation	9
5.3	Dehumidifying operation	10
5.4	Timer operation	10
<hr/>		
6	Handling the remote controller	12
6.1	Location of the remote controller	12
6.2	Using the remote controller holder(optional)	13
6.3	Replacing batteries	13

1 Key to symbols and safety instructions

1.1 Key to symbols



Buttons design is based on typical model and might be slightly different from the actual one you purchased, the actual shape shall prevail.

Warnings



Warnings in this document are identified by a warning triangle printed against a grey background. Keywords at the start of a warning indicate the type and seriousness of the ensuing risk if measures to prevent the risk are not taken.

The following keywords are defined and can be used in this document:

- ▶ **DANGER** indicates a hazardous situation which, if not avoided, will result in death or serious injury.
- ▶ **WARNING** indicates a hazardous situation which, if not avoided, could result in death or serious injury.
- ▶ **CAUTION** indicates a hazardous situation which, if not avoided, could result in minor to moderate injury.
- ▶ **NOTICE** is used to address practices not related to personal injury.

Important information



This symbol indicates important information where there is no risk to people or property.

2 Remote controller specifications

Model / Part Number	RG57A6 / 7738005548
Rated Voltage	3.0V (Alkaline AAA ×2)
Transmission Distance	up to 25 ft
Environment	23°F ~ 140°F

Table 1

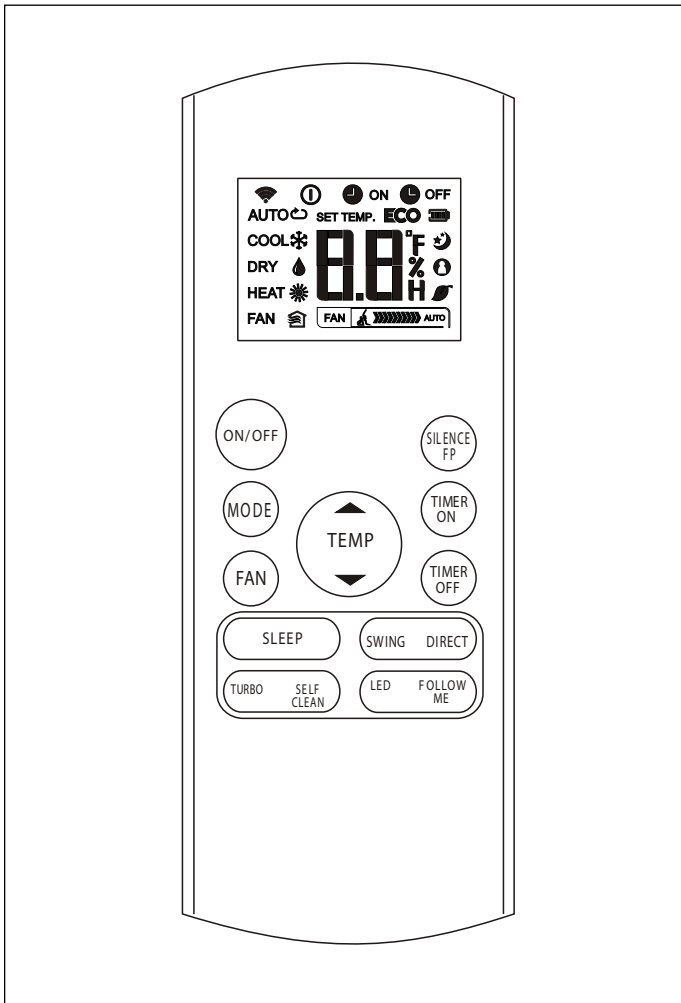

Figure 1

3 Operation of buttons

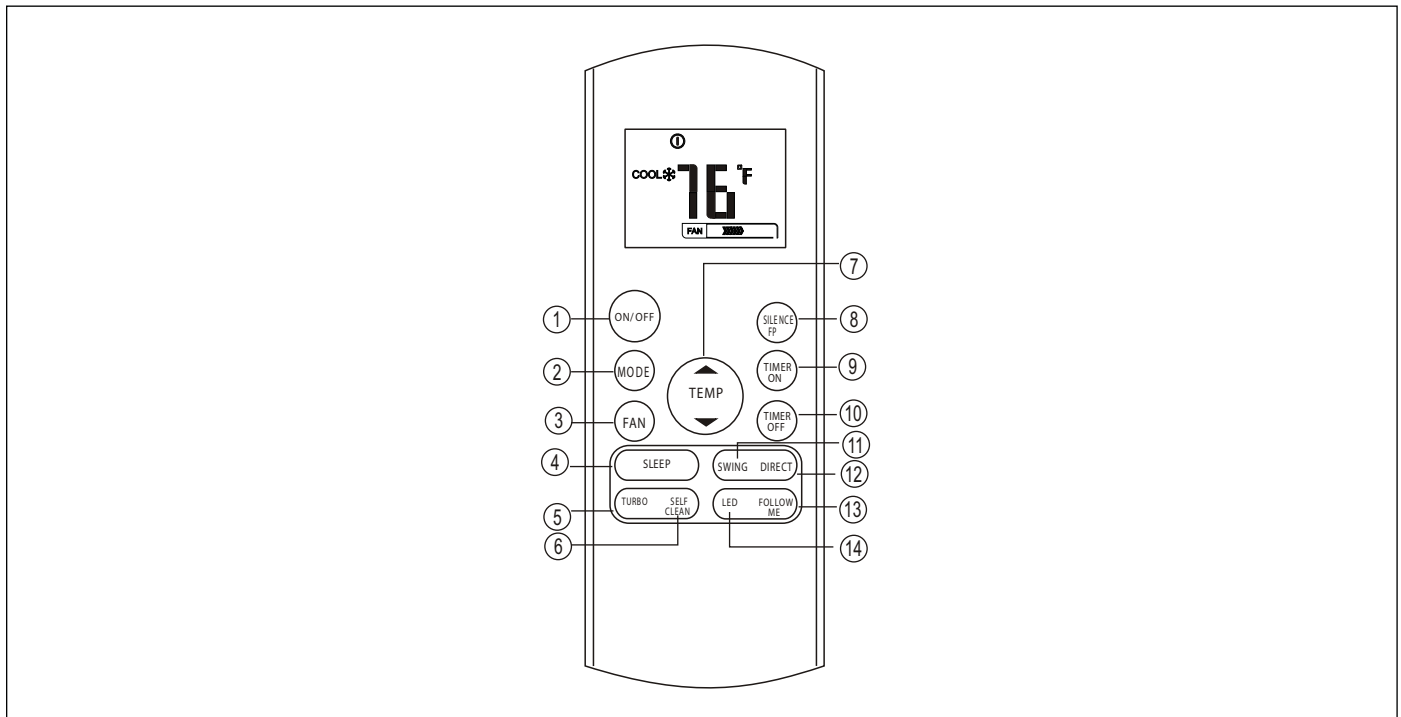

Figure 2

1. ON/OFF Button: Press this button to turn the air conditioner ON or OFF.

2. MODE Button: Press this button to select the air conditioner / heat pump's mode of operation.



3. FAN Button: Press this button to select the fan speed.

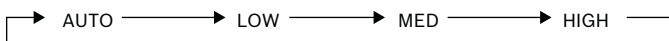

i You can not switch the fan speed in AUTO or DRY mode

4. SLEEP Button: Press this button to Activate/Disable the SLEEP function.

- ▶ The SLEEP function can maintain the most comfortable temperature while saving energy. This function is available in COOL, HEAT or AUTO modes only.
- ▶ For more information on the SLEEP function operation, please reference the unit's USER MANUAL.

i While the unit is running in SLEEP mode, it will be cancelled if the MODE, FAN SPEED or ON/OFF button is pressed.

5. TURBO Button: Press this button to Activate/Disable the TURBO function. TURBO function enables the unit to reach the preset temperature at cooling or heating operation in the shortest time possible. The fan will run at a speed above HIGH.

6. SELF CLEAN Button: Press this button to Activate/Disable the SELF CLEAN function. Under SELF CLEAN mode, the air conditioner will automatically clean and dry the evaporator and blower fan.

7. Temperature Control:

UP Button (▲): Push this button to increase the indoor temperature setting in 1°F increments, limited to 86°F.

DOWN Button (▼): Push this button to decrease the indoor temperature setting in 1°F increments, limited to 62°F.

i Temperature control is not available in Fan mode.

i Press and hold the UP and DOWN buttons together for 3 seconds to alternate the temperature display between the °C & °F scales.

Operation of buttons continued

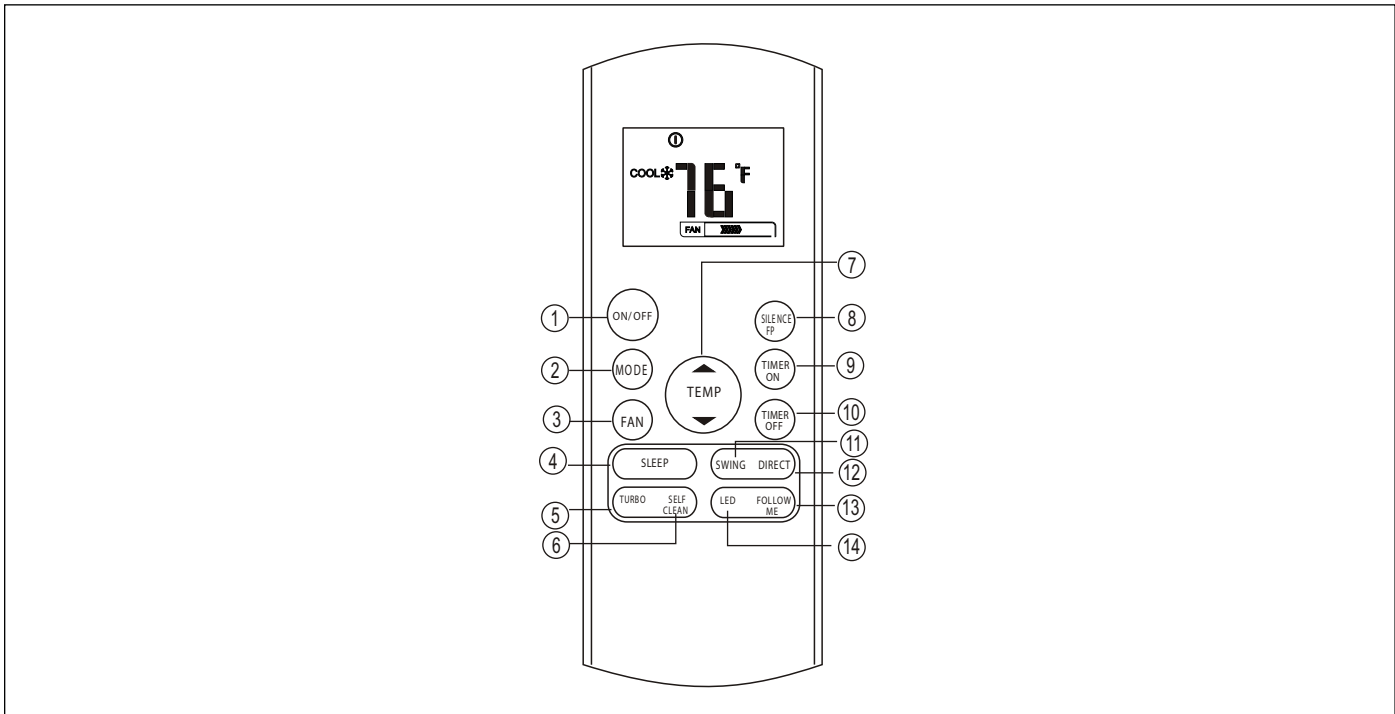

Figure 3

8. SILENCE/FP (Freeze Protection) Button:

- ▶ Press to Activate/Disable the SILENCE function. Hold this button for more than 2 seconds to activate/disable the FP function.
- ▶ When the SILENCE function is activated, the compressor will operate at low frequency and the indoor unit will run at a very low fan setting, which will reduce the noise to the lowest level and create a quiet, comfortable environment while still providing heating or cooling to the room. Due to operating the compressor at a low frequency, the cooling and heating capacity will be reduced.
- ▶ The FP function can only be activated during heating operation (when mode is set to HEAT). The unit will operate at a setting temperature of 46°F. The indoor unit will display FP. Press the ON/OFF, SLEEP, FP, MODE, FAN SPEED, UP or DOWN button to cancel the FP function.

9. TIMER ON Button:

Press this button to initiate the auto-on time sequence. Each press will increase the auto-timed setting in 30 minute increments. When the setting time displays 10.0, each press will increase the auto-timed setting in 60 minutes increments. To cancel the auto-timed program, simply adjust the auto-on time to 0.0.

10. TIMER OFF Button:

Press this button to initiate the auto-off time sequence. Each press will increase the auto-timed setting in 30 minute increments. When the setting time displays 10.0, each press will increase the auto-timed setting in 60 minute increments. To cancel the auto-timed program, simply adjust the auto-off time to 0.0.

11. SWING Button: Press this button to activate/disable the horizontal louver auto SWING feature. The auto SWING feature will rotate the horizontal louver up and down, blowing air into the room in a continuously moving up/down motion.

12. DIRECT Button: Press this button to change the louver angle and set the desired up/down air flow direction. The louver changes 6° in angle for each press.

13. FOLLOW ME Button: Push this button to activate/disable the FOLLOW ME feature. The remote controller will display the actual temperature at its location, and the remote controller will be used as the thermostat temperature at which the system will try to satisfy the set point. The remote controller will send this signal to the air conditioner every 3 minutes. The air conditioner will cancel the FOLLOW ME feature automatically if it does not receive a signal from the remote controller during any 7 minute interval.

14. LED Button: Press this button to Activate/Disable the indoor unit screen Display. Press this button to light the display or clear the display.

4 Indicators on LCD

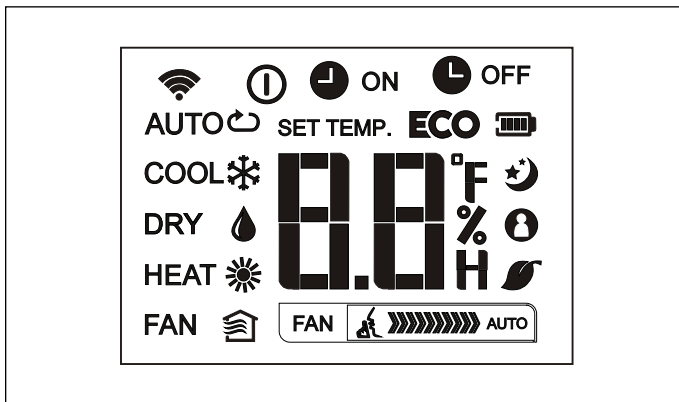

Figure 4

Icon	Description
	AUTO Mode
	COOL Mode
	DRY Mode
	HEAT Mode
	FAN Mode
	Displayed when data transmitted.
	Displayed when remote controller is ON.
	Battery display (low battery detection)
ECO	Not applicable for this unit
	Displayed when TIMER ON time is set.
	Displayed when TIMER OFF time is set.
	Set temperature, room temperature, or time depending on current mode and function.
	Displayed when SLEEP function is active.
	Displayed when FOLLOW ME function is active.
	Not applicable for this unit
	Not applicable for this unit
	Low fan speed
	Medium fan speed
	High fan speed
	Auto fan speed

Table 2

All indicators are shown in the figure, but during actual operation only the relative functional signs are shown on the display window.

5 How to use the buttons

5.1 Auto operation

Ensure the unit is plugged in and power is available. The OPERATION indicator on the display panel of the indoor unit will be flashing.

1. Press the MODE button to select AUTO.
2. Press the UP/DOWN button to set the desired temperature. The temperature can be set within a range of 62°F ~ 86°F in 1°F increments.
3. Press the ON/OFF button to start the air conditioner.

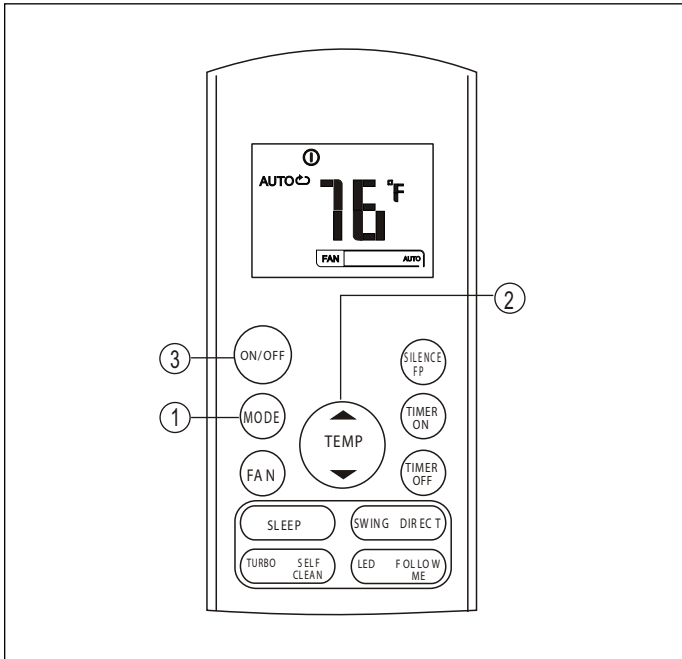

Figure 5

- i** 1. In the Auto mode, the air conditioner can logically choose the mode of Cooling, Fan, and Heating by sensing the difference between the actual ambient room temperature and the setting temperature on the remote controller.
- 2. In the Auto mode, you can not switch the fan speed. The fan speed will be automatically controlled.
- 3. If the Auto mode is not comfortable, the desired mode can be selected manually.

5.2 Cooling /Heating/Fan operation

Ensure the unit is plugged in and power is available. The OPERATION indicator on the display panel of the indoor unit will be flashing.

1. Press the MODE button to select COOL or FAN mode.
2. Press the UP/DOWN buttons to set the desired temperature. In COOL or HEAT mode, the temperature can be set within a range of 62°F~ 86°F in 1°F increments.
3. Press the FAN button to select the fan speed in four steps- Auto, Low, Med, or High.
4. Press the ON/OFF button to start the air conditioner.

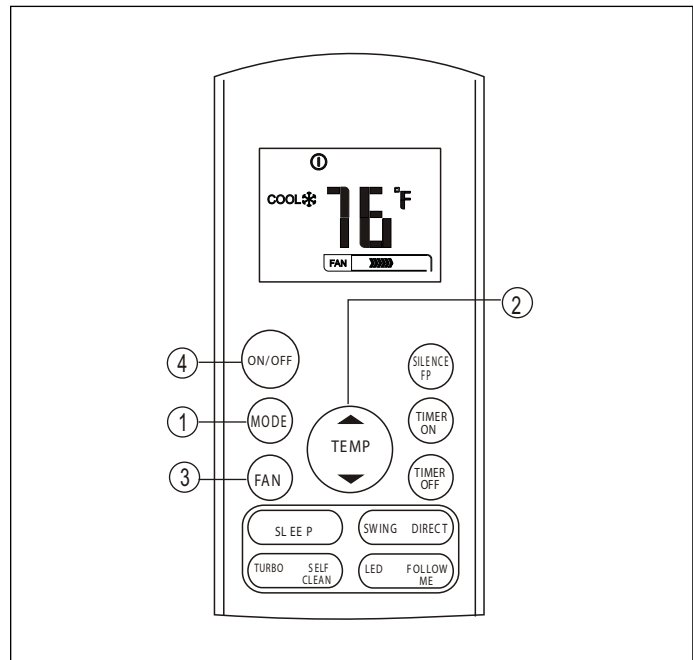

Figure 6

- i** In the FAN mode, the setting temperature is not displayed on the remote controller and you are not able to control the room temperature. In this case, only step 1, 3 and 4 may be performed.

5.3 Dehumidifying operation

Ensure the unit is plugged in and power is available. The OPERATION indicator on the display panel of the indoor unit will be flashing.

1. Press the MODE button to select DRY mode.
2. Press the UP/DOWN buttons to set the desired temperature. The temperature can be set within a range of 62°F ~ 86°F in 1°F increments.
3. Press the ON/OFF button to start the air conditioner.

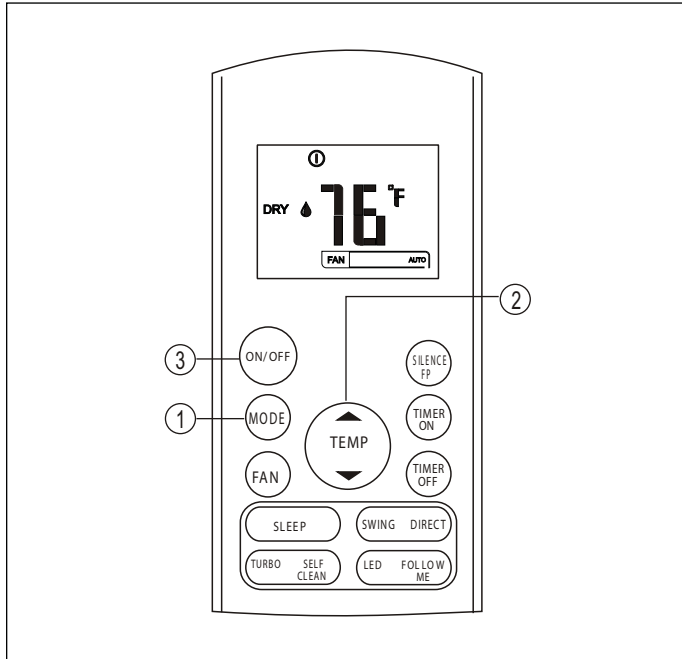

Figure 7



In the Dehumidifying mode, you can not switch the fan speed. The fan speed will be automatically controlled.

5.4 Timer operation

Press the TIMER ON button to set the auto-on time of the unit. Press the TIMER OFF button to set the auto-off time of the unit.

To set the Auto-on time.

1. Press the TIMER ON button. The remote controller shows TIMER ON, and the last Auto-on setting time will be shown on the LCD display area. Now it is ready to reset the Auto-on time. This feature will turn the unit on after the specified time.
2. Push the TIMER ON button again to set desired Auto-on time. Each time you press the button, the time increases by half an hour between 0 and 10 hours and by one hour between 10 and 24 hours.
3. After setting the TIMER ON, there will be a one second delay before the remote controller transmits the signal to the air conditioner. Then, after approximately another 2 seconds, the time will disappear and the set temperature will re-appear on the LCD display window.

To set the Auto-off time.

1. Press the TIMER OFF button. The remote controller shows TIMER OFF, and the last Auto-off setting time will be shown on the LCD display area. Now it is ready to reset the Auto-off time. This feature will turn the unit off after the specified time.
2. Push the TIMER OFF button again to set desired Auto-off time. Each time you press the button, the time increases by half an hour between 0 and 10 hours and by one hour between 10 and 24 hours.
3. After setting the TIMER OFF, there will be a one second delay before the remote controller transmits the signal to the air conditioner. Then, after approximately another 2 seconds, the time will disappear and the set temperature will re-appear on the LCD display window.

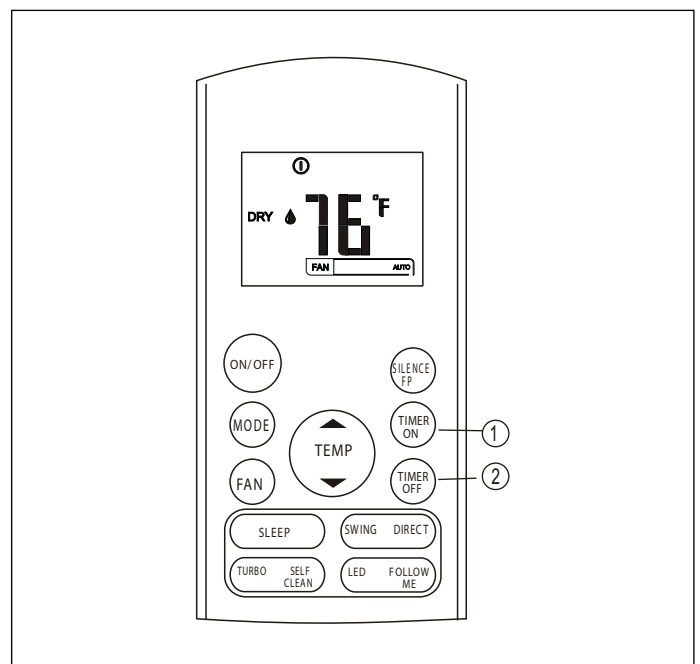

Figure 8



CAUTION:

- ▶ When you select the timer operation, the remote controller automatically transmits the timer signal to the indoor unit for the specified time. Therefore, keep the remote controller in a location where it can transmit the signal to the indoor unit properly.
- ▶ The effective operation time set by the remote controller for the timer function is limited to the following settings: 0.5, 1.0, 1.5, 2.0, 2.5, 3.0, 3.5, 4.0, 4.5, 5.0, 5.5, 6.0, 6.5, 7.0, 7.5, 8.0, 8.5, 9.0, 9.5, 10, 11, 12, 13, 14, 15, 16, 17, 18, 19, 20, 21, 22, 23 and 24. These represent the number of hours for which the unit will wait to turn on or off.

Examples of timer setting

TIMER ON (Auto-on Operation)

The TIMER ON feature is useful when you want the unit to turn on automatically before you return home. The air conditioner will automatically start operating at the set time.

Example:

To start the air conditioner in 6 hours.

1. Press the TIMER ON button, the last setting of starting operation time will show on the display area.
2. Press the TIMER ON button to display "6.0H" on the TIMER ON display of the remote controller.
3. Wait for 3 seconds and the digital display area will show the temperature again. The "TIMER ON" indicator remains on when this function is active.

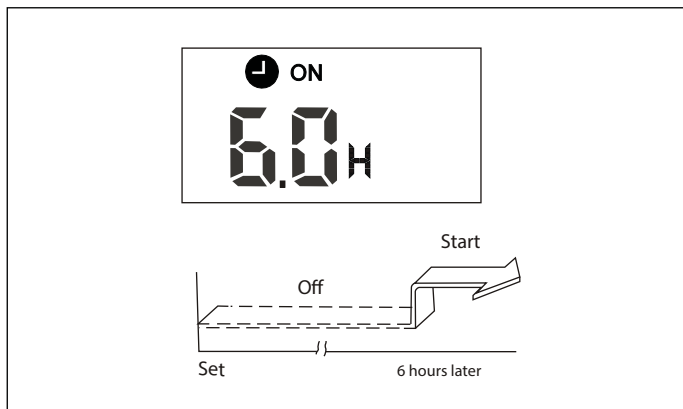

Figure 9

TIMER OFF (Auto-off Operation)

The TIMER OFF feature is useful when you want the unit to turn off automatically after you go to bed. The air conditioner will stop automatically at the set time.

Example:

To stop the air conditioner in 10 hours.

1. Press the TIMER OFF button, the last setting of stopping operation time will show on the display area.
2. Press the TIMER OFF button to display "10H" on the TIMER OFF display of the remote controller.
3. Wait for 3 seconds and the digital display area will show the temperature again. The "TIMER OFF" indicator remains on when this function is active.

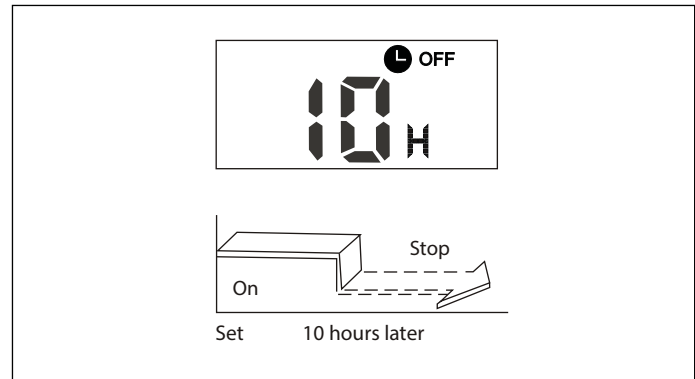

Figure 10

COMBINED TIMER (Setting both ON and OFF timers simultaneously)

TIMER OFF TIMER ON (On Stop Start operation)

This feature is useful when you want to stop the air conditioner after you go to bed, and start it again in the morning when you wake up or when you return home.

Example:

To stop the air conditioner 2 hours after setting and start it again 10 hours after setting.

1. Press the TIMER OFF button.
2. Press the TIMER OFF button again to display "2.0H" on the TIMER OFF display.
3. Press the TIMER ON button.
4. Press the TIMER ON button again to display "10H" on the TIMER ON display .
5. Wait for 3 seconds and the digital display area will show the temperature again. The "TIMER ON OFF" indicator remains on and this function is activated.

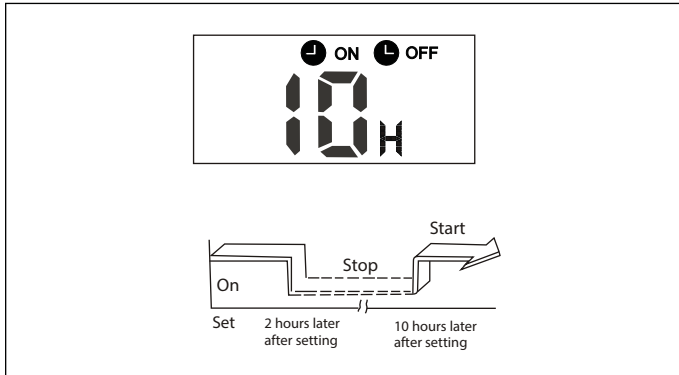

Figure 11

6 Handling the remote controller**6.1 Location of the remote controller**

Use the remote controller within a distance of approximately 25 feet from the appliance, pointing it towards the receiver. Reception of new information is confirmed by a beep.

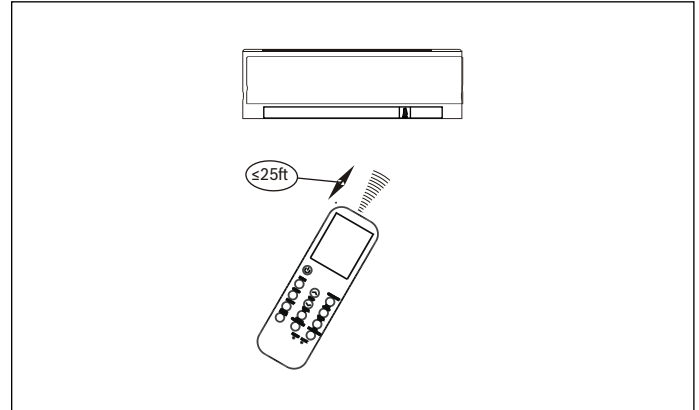

Figure 12

NOTICE:

- ▶ The air conditioner will not operate if curtains, doors or other materials block the signal between the remote controller and the indoor unit.
- ▶ Prevent any liquid from falling onto the remote controller. Do not expose the remote controller to direct sunlight or heat.
- ▶ If the infrared signal receiver on the indoor unit is exposed to direct sunlight, the air conditioner may not function properly. Use curtains over windows to prevent the sunlight from falling on the receiver.
- ▶ Do not drop the remote controller. Handle with care.
- ▶ Do not place heavy objects on the remote controller, or step on it.

6.2 Using the remote controller holder(optional)

The remote controller can be attached to a wall or pillar by using a remote controller holder.

1. Before installing the remote controller, check that the air conditioner receives the signal properly.
2. Install the remote controller holder with two screws.
3. For installing or removing the remote controller, move it up or down in the holder.

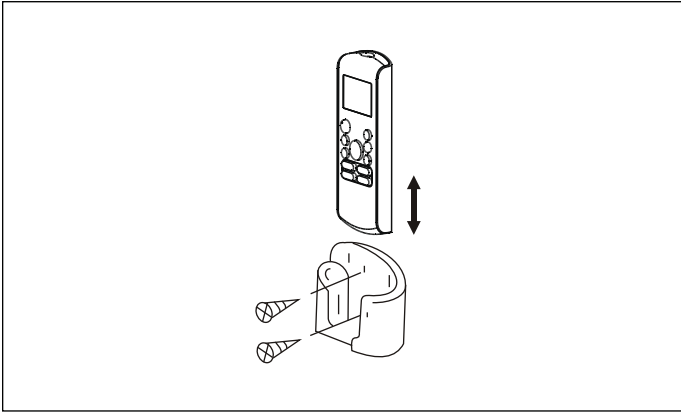

Figure 13

6.3 Replacing batteries

The following cases signify exhausted batteries. Replace old batteries with new ones.

- ▶ Receiving beep is not emitted when a signal is transmitted.
- ▶ Indicator fades away.

The remote controller is powered by two dry batteries (Alkaline AAA x 2) housed in the back rear part and protected by a cover.

1. Remove the cover in the rear part of the remote controller.
2. Remove the old batteries and insert the new batteries, placing the (+) and (-) ends correctly.
3. Re-install the cover.

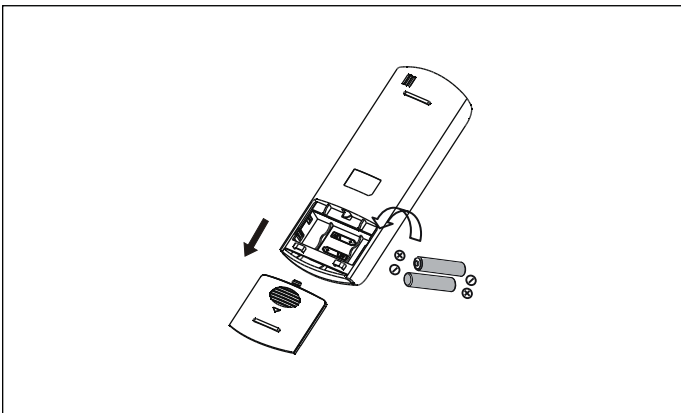

Figure 14



When the batteries are removed, the remote controller erases all settings and timers. After inserting new batteries, settings and timers must be reset.



CAUTION:

- ▶ Do not mix old and new batteries or batteries of different types.
- ▶ Do not leave the batteries in the remote controller if they are not going to be used for 2 months or longer.
- ▶ Dispose of batteries properly, per local and national codes or requirements.

United States and Canada

**Bosch Thermotechnology Corp.
50 Wentworth Avenue
Londonderry, NH 03053**

**Tel: 866-642-3198
Fax: 954-776-5529
www.boschheatingandcooling.com**