

ASSEMBLY INSTRUCTION

SKU CODE : (WF286300/WF286301/WF286302)

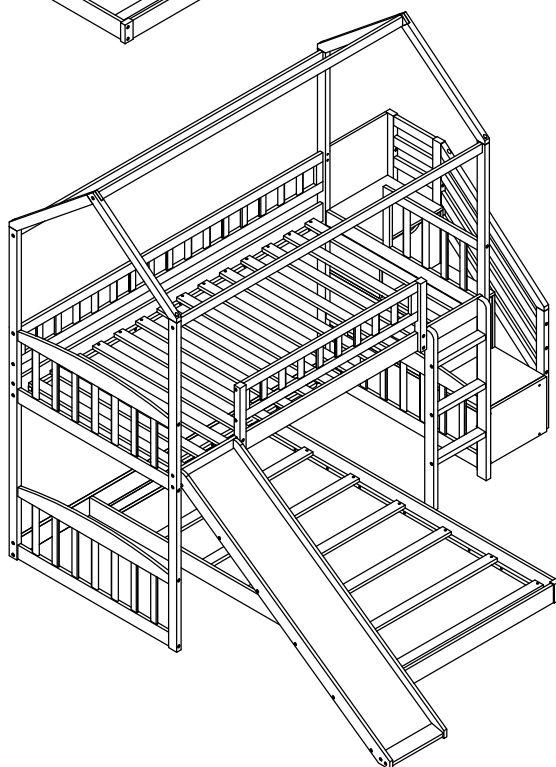

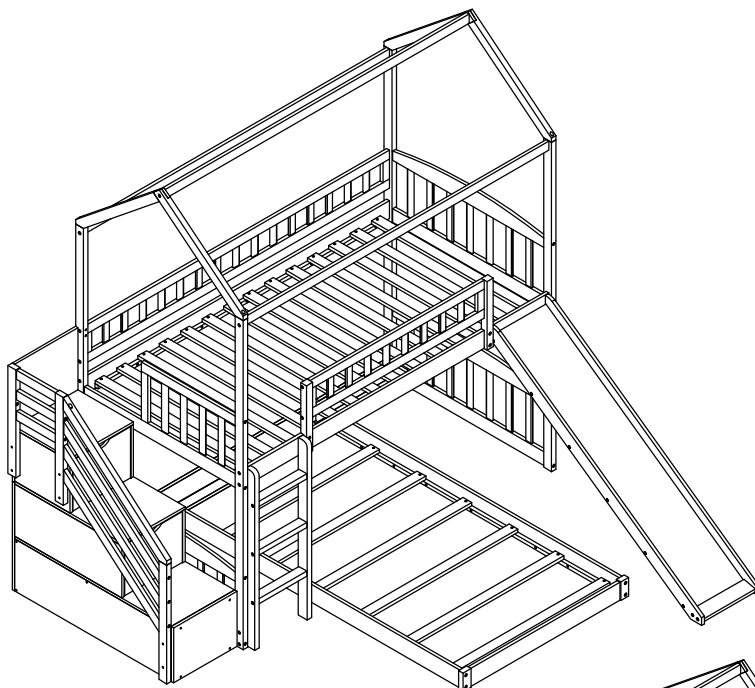

SAFETY WARNINGS



1. This bed is designed for use only mattress(es) meeting the following specifications on the upper bunk, and lower bunk:

Upper bunk (bunk bed and tribed included)

Bed Type	Length	Width	Thickness
<i>Twin Standard</i>	<i>74"-75"</i>	<i>37 ½"-38 ½"</i>	<i>6" max</i>

Lower bunk

Bed Type	Length	Width	Thickness
<i>Twin Standard</i>	<i>74"-75"</i>	<i>37 ½"-38 ½"</i>	<i>8"</i>

2. Replacement parts, including additional guardrails, maybe obtained from any of our (GIGACLOUD TECHNOLOGY (USA) INC. 18961 ARENTH AVENUE CITY OF INDUSTRY, CA, 91748) dealers.
3. Follow the information on the warnings appearing on the upper bunk bed end structure and on the carton. Do not remove warning label from bed.
4. Always use the recommended size mattresses or mattress supports, or both, to help prevent the likelihood of entrapment or falls.
5. Surface of the mattress must be at least 5" . (127 mm) below the upper edge of guardrails.
6. Do not allow children under 6 years of age to use the upper bunk.
7. Periodically check and ensure that the guardrail, ladder, and other components are in their proper position, free from damage, and that all connectors are tight.
8. Do not allow horseplay on or under the bed and prohibit jumping on the bed
9. Always use the ladder for entering and leaving the upper bunk.
10. Do not use substitute parts. Contact the manufacturer or dealer for replacement parts.
11. Use of a night light may provided added safety precaution for a child using the upper bunk.
12. Always use guardrails on both long sides of the upper bunk. If the bunk bed will be placed next to the wall, the guardrail that runs the full length of the bed should be placed against the wall to prevent entrapment between the bed and wall.
13. The use of water or sleep flotation mattresses is prohibited.
14. STRANGULATION HAZARD – Never attach or hang items to any part of the bunk bed that are not designed for use with the bed; for example, but not limited to, hook, belts and jump ropes.
15. Keep these instructions for future reference
16. Prohibit more than one person on upper bunk.
17. We recommend assembling your bunk bed on the shipping carton to protect your floor or carpet.
18. Be certain all staples are out of the box before beginning assembly on the shipping carton.



SAFETY WARNINGS



1. **At the beginning :**
 - Tighten all hardware.
 - Check metal parts for rust. If found, sand and repaint using a non-lead-based paint meeting the requirements of 16 CFR 1303.
 - Check all wood members for deterioration and splinters. Sand down splinters and replace deteriorating wood members.
 - Rake and check depth of loose fill protective surfacing materials to prevent compaction and to maintain appropriate depth. Replace as necessary.
2. **Twice a month**
 - Tighten all hardware.
 - Rake and check depth of loose fill protective surfacing materials to prevent compaction and to maintain appropriate depth. Replace as necessary.
3. **Owners shall be responsible for maintaining the legibility of the warning labels.**
4. **Disposal Instructions-**
 - There shall be instructions advising the owner to disassemble and dispose of the playground equipment in such a way that no unreasonable hazards will exist at the time the playground equipment is discarded.
5. **The instructions shall also include the information found in Section 4 of the United States Consumer Product Safety Commission's (USCPSC) Outdoor Home Playground Safety Handbook or specific surfacing guidelines for the product consistent with the USCPSC Handbook. A copy of this section may be found in Appendix X2.**
6. **Observing the following statements and warnings reduces the likelihood of serious or fatal injury.**
7. **Specifying the number and weight of occupants that may safely use the equipment singly or simultaneously,**
8. **Recommending on-site adult supervision for children of all ages,**
9. **Warning the owner to instruct children not to use the equipment in a manner other than intended,**
10. **Warning the owner to instruct children not to get off equipment while it is in motion,**
11. **Warning the owner not to allow children to wear inappropriate items, such as but not limited to, loose fitting clothing, hood and neck drawstrings, scarves, cord-connected items, capes and ponchos. These items can cause death by strangulation.**
12. **Warning the owner to instruct children not to climb when the equipment is wet.**
13. **Warning the owner to instruct children not to attach items to the playground equipment that are not specifically designed for use with the equipment, such as, but not limited to, jump ropes, clothesline, pet leashes, cables and chain as they may cause a strangulation hazard**
14. **Warning the owner to instruct children to remove their bike or other sports helmet before playing on the playground equipment.**
15. **Warning the owner to dress children with well-fitting and full foot enclosing footwear. Examples of inappropriate footwear are clogs, flip flops, and sandals.**
16. **Place the equipment on level ground, not less than 6 ft (1.8 m) from any structure or obstruction such as a fence, garage, house, overhanging branches, laundry lines, or electrical wires**
17. **Do not install home playground equipment over concrete, asphalt, packed earth, grass, carpet, or any other hard surface. A fall onto a hard surface can result in serious injury or death to the equipment user**
18. **To prevent serious injury, cautionary statements shall be included which warn that children must not use the equipment until properly installed.**

Detail View - BUNK HOUSE BED

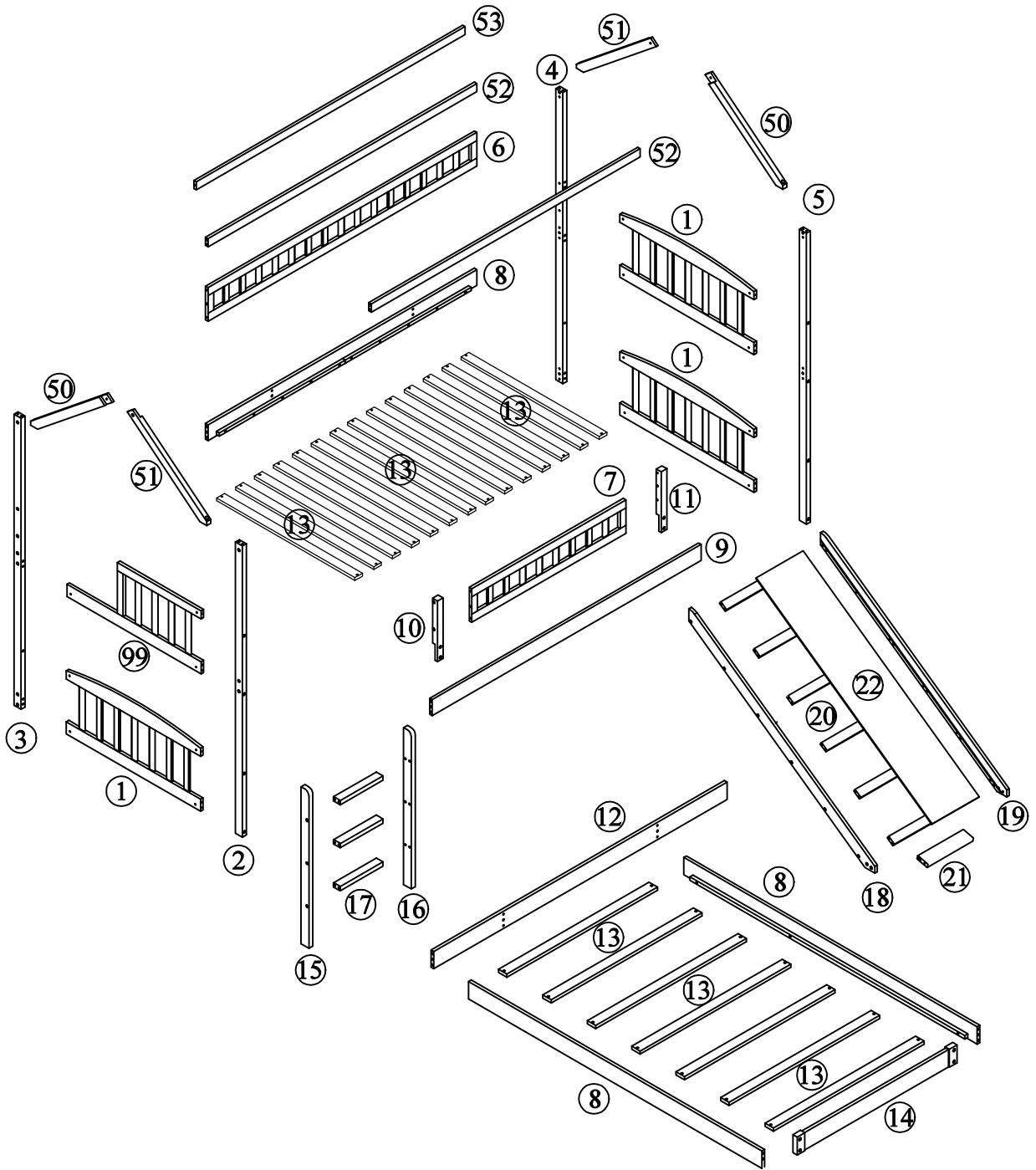

Identifying the Hardware -Identify the hardware using the illustrations below.



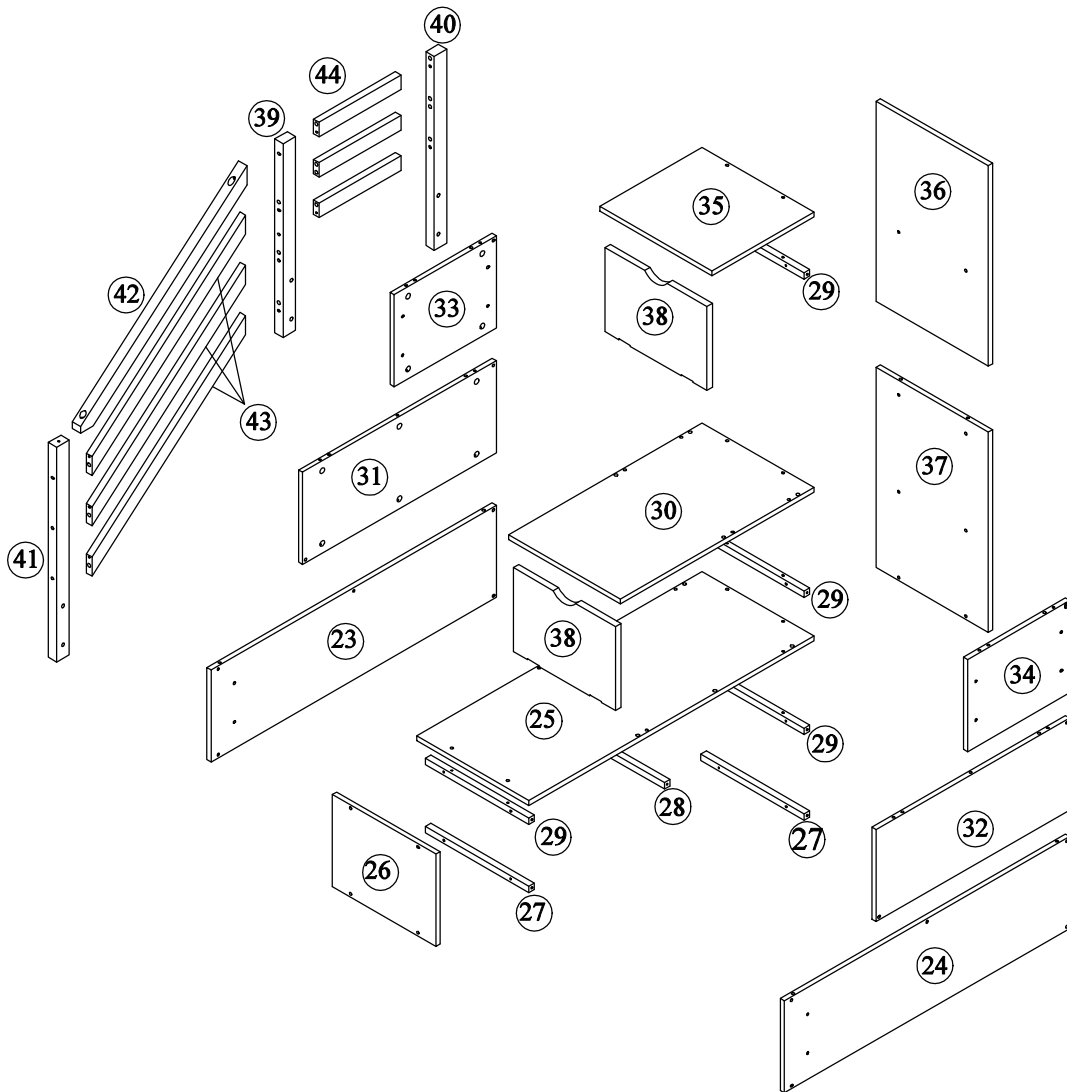

Detail View - STAIRS

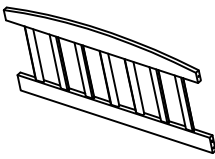
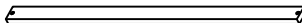
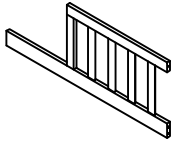



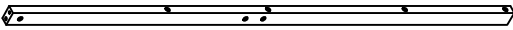
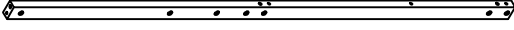

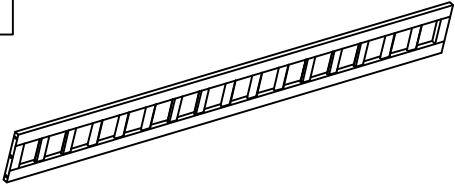
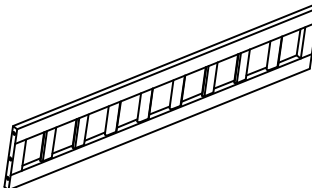
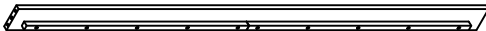
Part List—WF286300

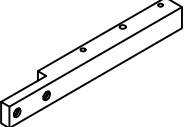
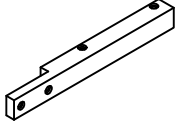
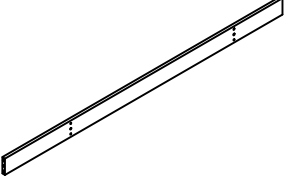
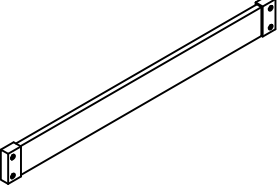
<p>1</p>  <p>Headboard - 3pcs</p>	<p>13</p>  <p>Bed board - 21pcs</p>
<p>99</p>  <p>Headboard - 1pc</p>	

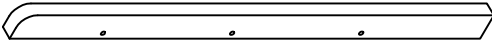
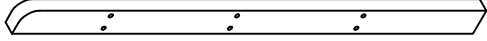
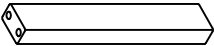
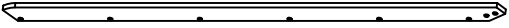

Part List—WF286301

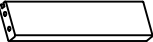
<p>2</p>  <p>Left front bed column- 1pc</p>	<p>3</p>  <p>Left rear bed column - 1pc</p>
<p>4</p>  <p>Right rear bed column - 1pc</p>	<p>5</p>  <p>Right front bed column- 1pc</p>
<p>6</p>  <p>Back guard rail frame - 1pc</p>	<p>7</p>  <p>Front guard rail frame - 1pc</p>
<p>8</p>  <p>Bed side plate - 3pcs</p>	<p>9</p>  <p>Bed side plate - 1pc</p>
<p>10</p>  <p>Left front guard rails support - 1pc</p>	<p>11</p>  <p>Right front guard rails support - 1pc</p>
<p>12</p>  <p>Lower bed side plate - 1pc</p>	<p>14</p>  <p>Foot board - 1pc</p>

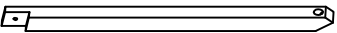
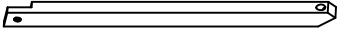
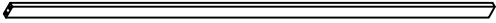
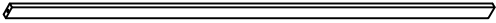

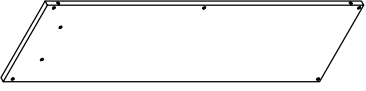
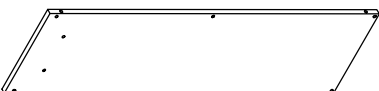

Part List—WF286301

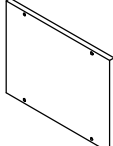
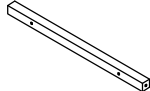
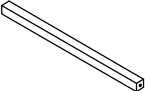
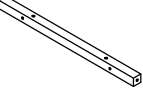
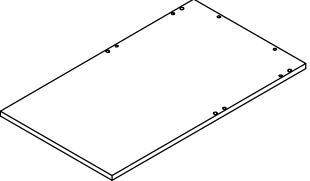
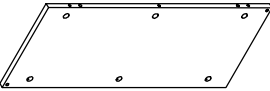
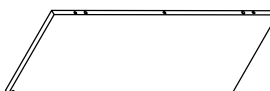
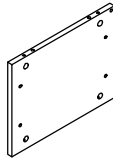
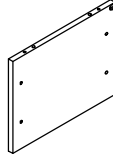
<p>15</p>  <p>Bed ladder column - 1pc</p>	<p>16</p>  <p>Bed ladder column - 1pc</p>
<p>17</p>  <p>Step of bed ladder - 3pcs</p>	<p>18</p>  <p>Slide column - 1pc</p>
<p>19</p>  <p>Slide column - 1pc</p>	<p>20</p>  <p>Slide support wood - 6pcs</p>
<p>21</p>  <p>Slide baffle - 1pc</p>	<p>22</p>  <p>Skate - 1pc</p>
<p>50</p>  <p>Roof connecting bar - 2pcs</p>	<p>51</p>  <p>Roof connecting bar - 2pcs</p>
<p>52</p>  <p>Roof connecting bar - 2pcs</p>	<p>53</p>  <p>Roof connecting bar - 1pc</p>



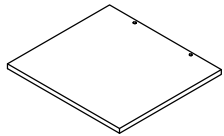
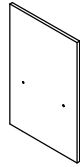
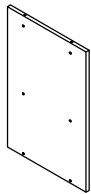
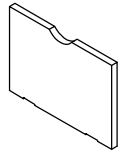
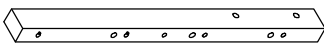
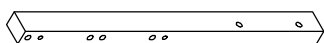

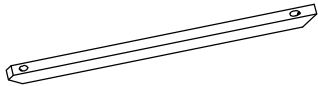

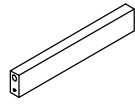



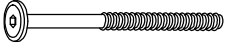

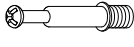

Part List—WF286302

23  Left Side panel- 1pc	24  Right Side panel- 1pc
25  Storage ladder bottom panel- 1pc	26  Storage ladder front panel- 1 pc
27  Storage ladder support - 2pcs	28  Storage ladder support - 1 pc
29  Storage ladder support - 4pcs	30  Storage ladder between panel - 1pc
31  Left Side panel- 1pc	32  Right Side panel- 1pc
33  Left Side panel- 1pc	34  Right Side panel- 1pc

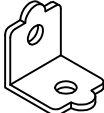
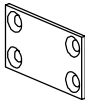
Part List—WF286302

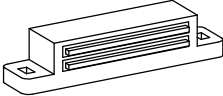
<p>35</p>  <p>Storage ladder top panel- 1pc</p>	<p>36</p>  <p>Storage ladder top back panel - 1pc</p>
<p>37</p>  <p>Storage ladder bottom back panel - 1pc</p>	<p>38</p>  <p>Storage ladder door panels- 2pcs</p>
<p>39</p>  <p>Storage ladder support- 1pc</p>	<p>40</p>  <p>Storage ladder support - 1pc</p>
<p>41</p>  <p>Storage ladder support- 1pc</p>	<p>42</p>  <p>Storage ladder support - 1pc</p>
<p>43</p>  <p>Storage ladder supports - 3pcs</p>	<p>44</p>  <p>Storage ladder supports- 3pcs</p>

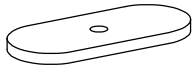

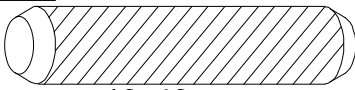
Hardware List—WF286300

<p>A</p>  <p>ø13x1/4"x80mm</p>	<p>B</p>  <p>ø13x1/4"x30mm</p>	<p>C</p>  <p>ø13x1/4"x30mm</p>
<p>Hex-Head bolts(15pcs)</p>	<p>Hex-Head bolts(4pcs)</p>	<p>Hex-Head screw(40pcs)</p>
<p>E</p>  <p>ø13*1/4"x80mm</p>	<p>F</p>  <p>ø10x13mm</p>	<p>G</p>  <p>ø6x35mm</p>
<p>Hex-Head screw(12pcs)</p>	<p>Horizontal-Hole bolts(35pcs)</p>	<p>Three in one bolts(26pcs)</p>
<p>H</p>  <p>ø14.5x12mm</p>	<p>I</p>  <p>ø8xø4x30mm</p>	<p>K</p>  <p>ø7xø3.5x18mm</p>
<p>Three in one lock(26pcs)</p>	<p>Round head screw(42pcs)</p>	<p>Flat head screw(12pcs)</p>
<p>L</p>  <p>20x20x19mm</p>	<p>M</p>  <p>50x31x2mm</p>	<p>N</p>  <p>ø7xø3.5x15mm</p>
<p>L-Bracket (2pcs)</p>	<p>Connecting iron sheet(3pcs)</p>	<p>Flat head screw(16pcs)</p>
<p>O</p>  <p>45x16x14mm</p>	<p>P</p>  <p>ø6xø3x12mm</p>	<p>Q</p>  <p>35x12x1mm</p>
<p>Door magnet(2pcs)</p>	<p>Round head screw(4pcs)</p>	<p>Magnetic iron sheet(2pcs)</p>
<p>R</p>  <p>ø6xø3x12mm</p>	<p>S</p>  <p>4mm</p>	<p>T</p>  <p>ø10x40mm</p>
<p>Flat head screw(10pcs)</p>	<p>Allen key(1pc)</p>	<p>Wood dowel(61pcs)</p>

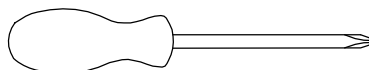
ASSEMBLY TOOLS REQUIRED (NOT INCLUDED)



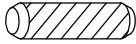
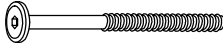

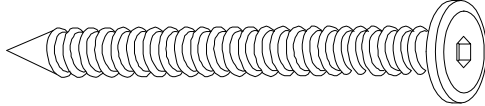
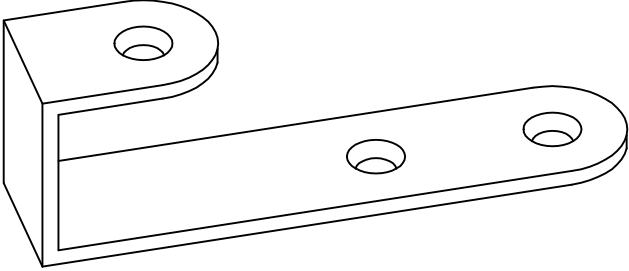
Hardware List—WF286300

<p>U</p>  <p>ø8x30mm</p>	<p>V</p>  <p>ø13x1/4"x70mm</p>	<p>W</p>  <p>ø13x1/4"x50mm</p>
<p>Wood dowel(22pcs)</p>	<p>Hex-Head bolts(16pcs)</p>	<p>Hex-Head bolts(4pcs)</p>
<p>X</p>  <p>ø13*1/4"x60mm</p>	<p>D</p>  <p>ø13xø6.2x50mm</p>	
<p>Hex-Head screw(14pcs)</p>	<p>Hex-Head screw(28pcs)</p>	
<p>J</p>  <p>ø75x18x24mm</p> <p>Stair hook(4pcs)</p>		

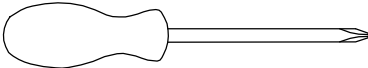
ASSEMBLY TOOLS REQUIRED (NOT INCLUDED)





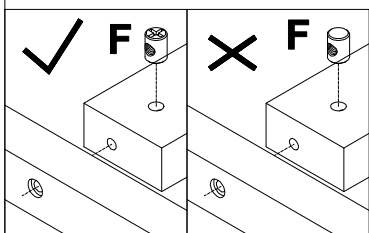
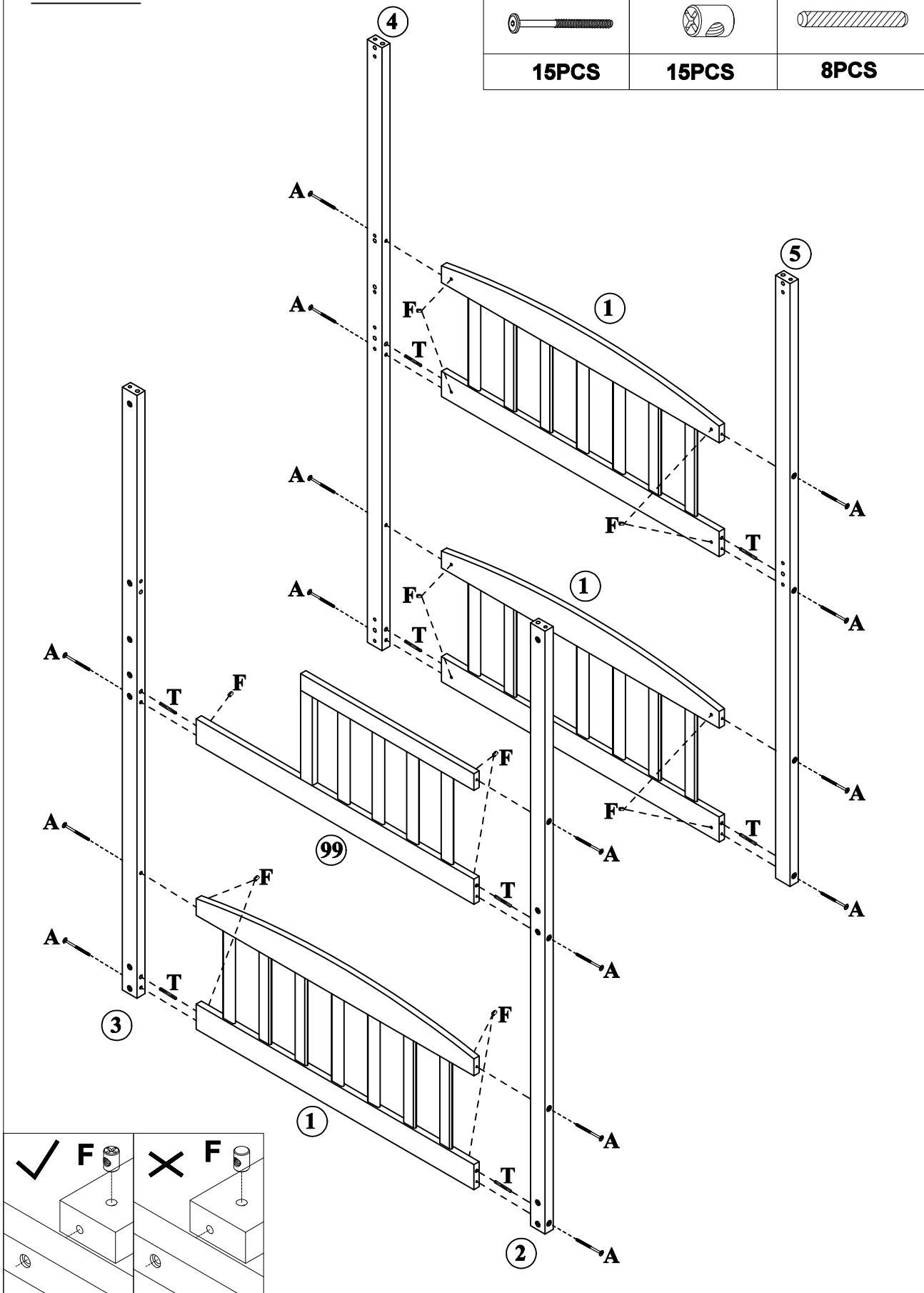

STEP: 1

A	F	T
		
15PCS	15PCS	8PCS

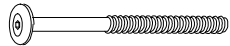

STEP: 2

V	X	F	T
			
12PCS	8PCS	12PCS	12PCS

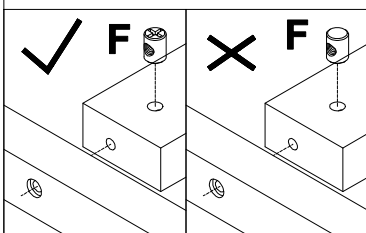
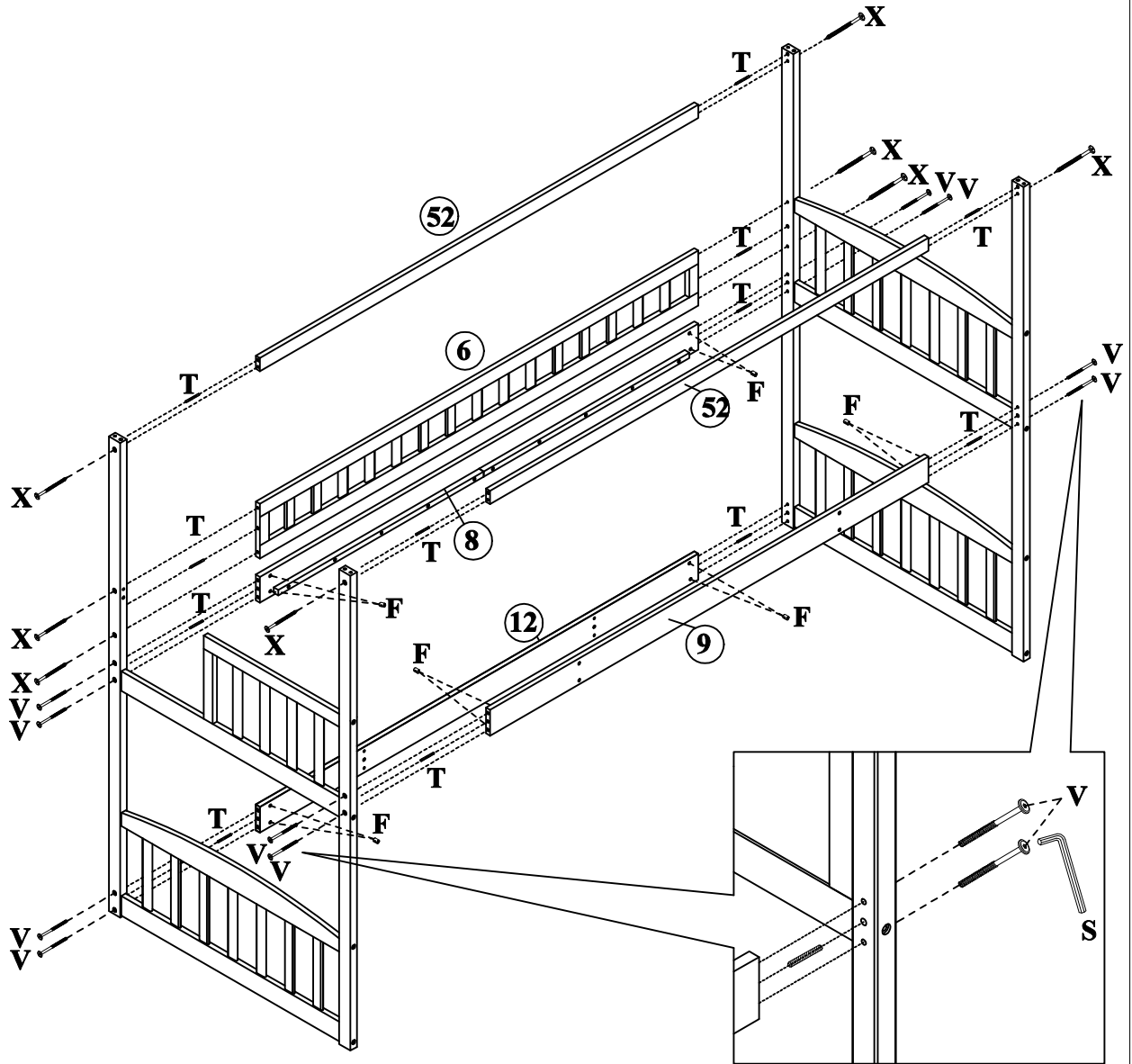

STEP: 3

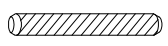
X	T
	
4PCS	2 PCS

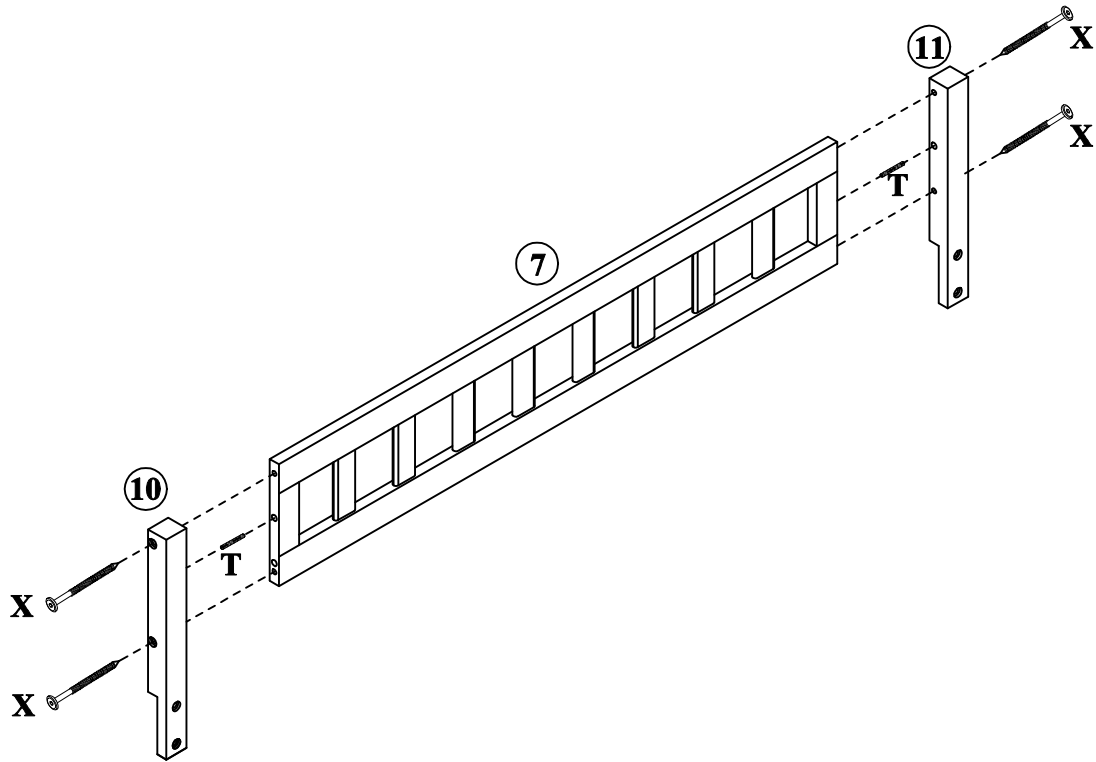



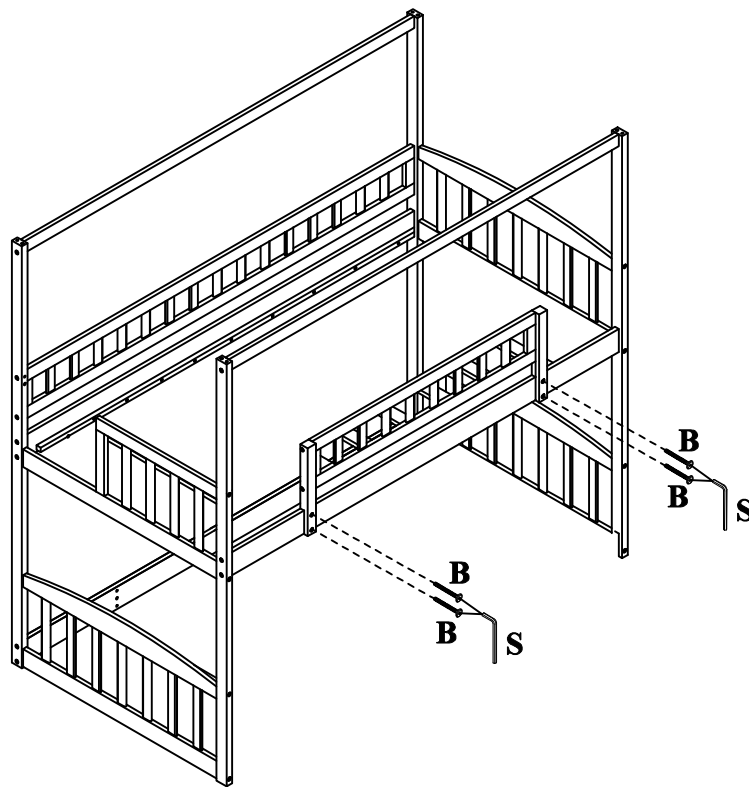

STEP: 4

B

4PCS

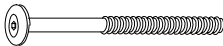

STEP: 5

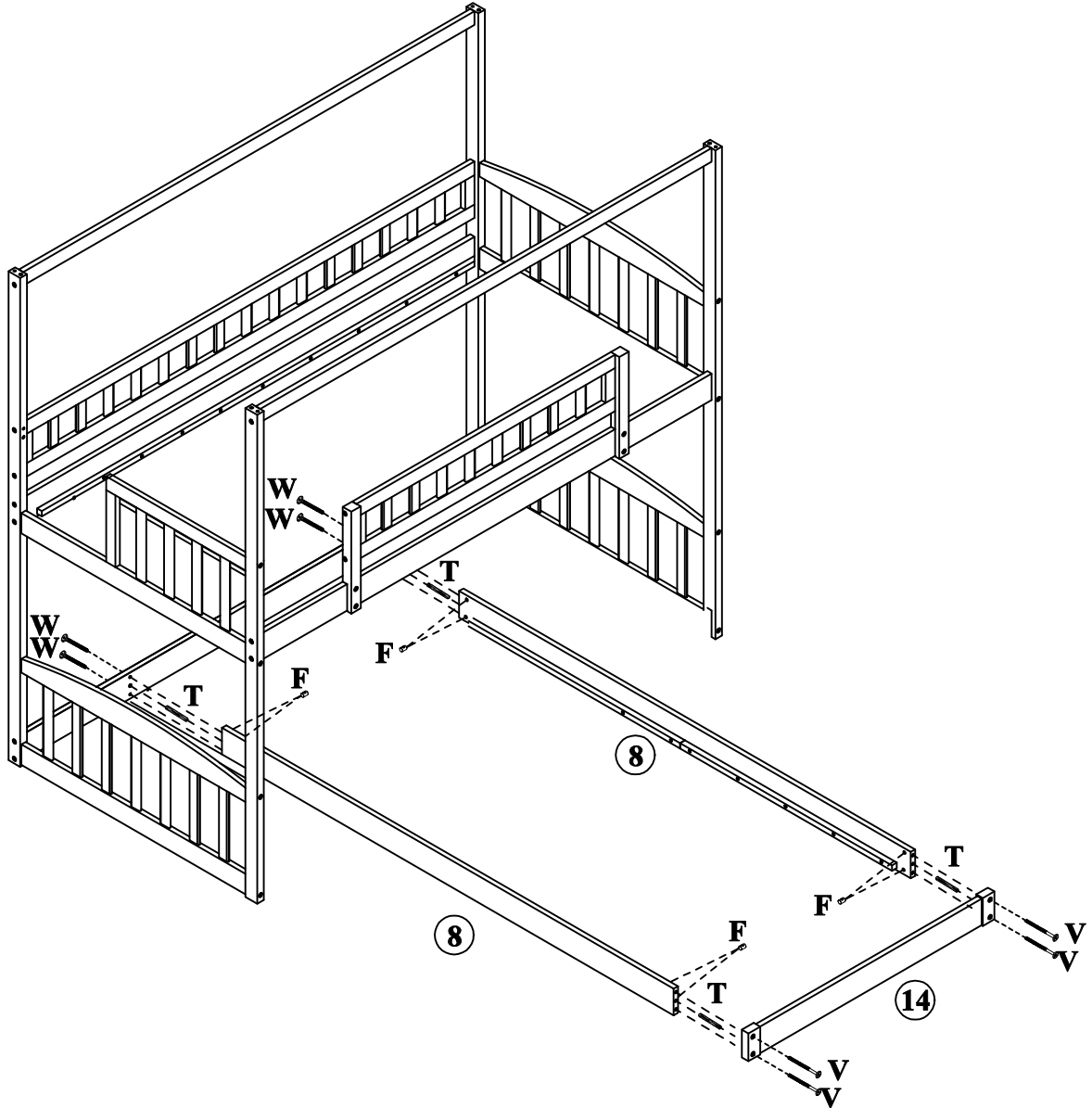
F	T	V	W
			
8PCS	4 PCS	4PCS	4 PCS



STEP: 6

I



42PCS

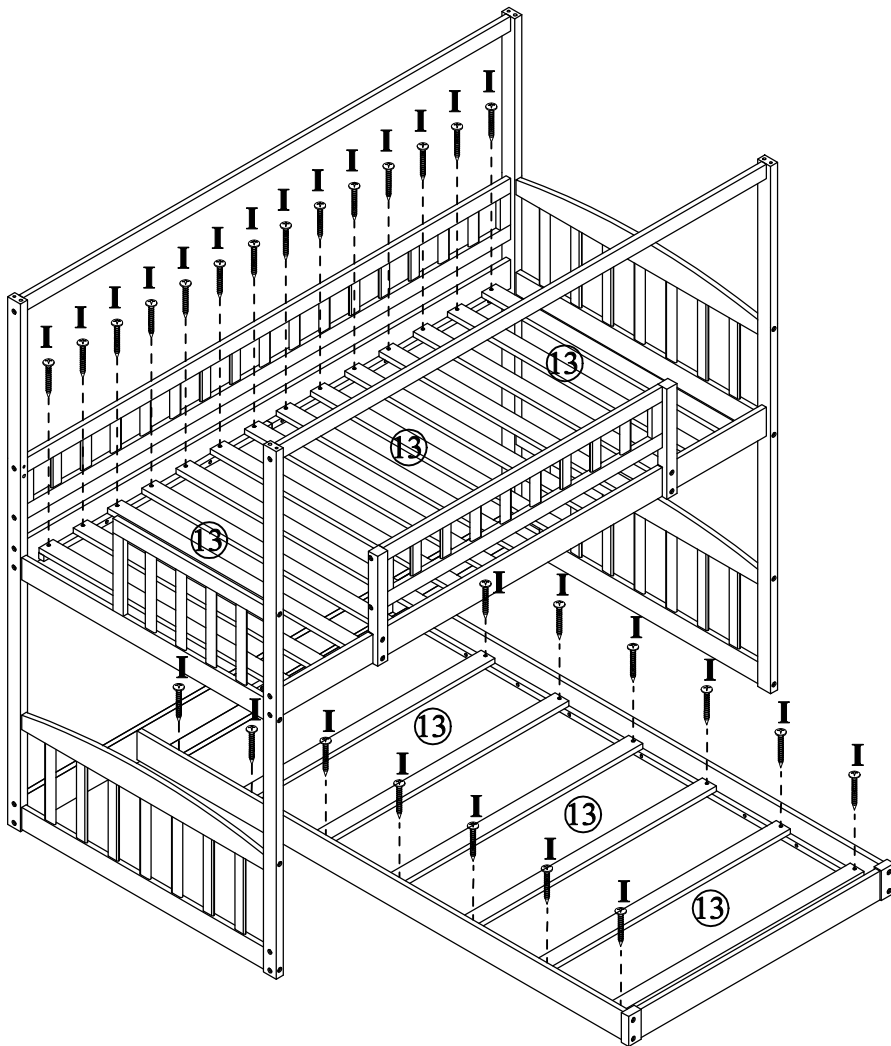

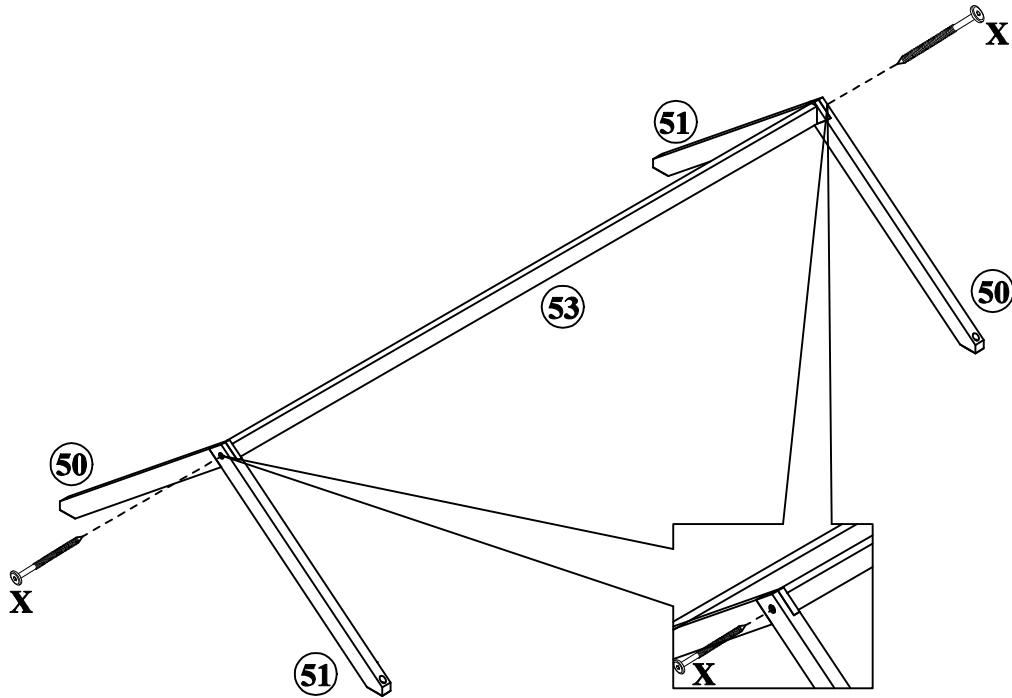

STEP: 7

X

2PCS



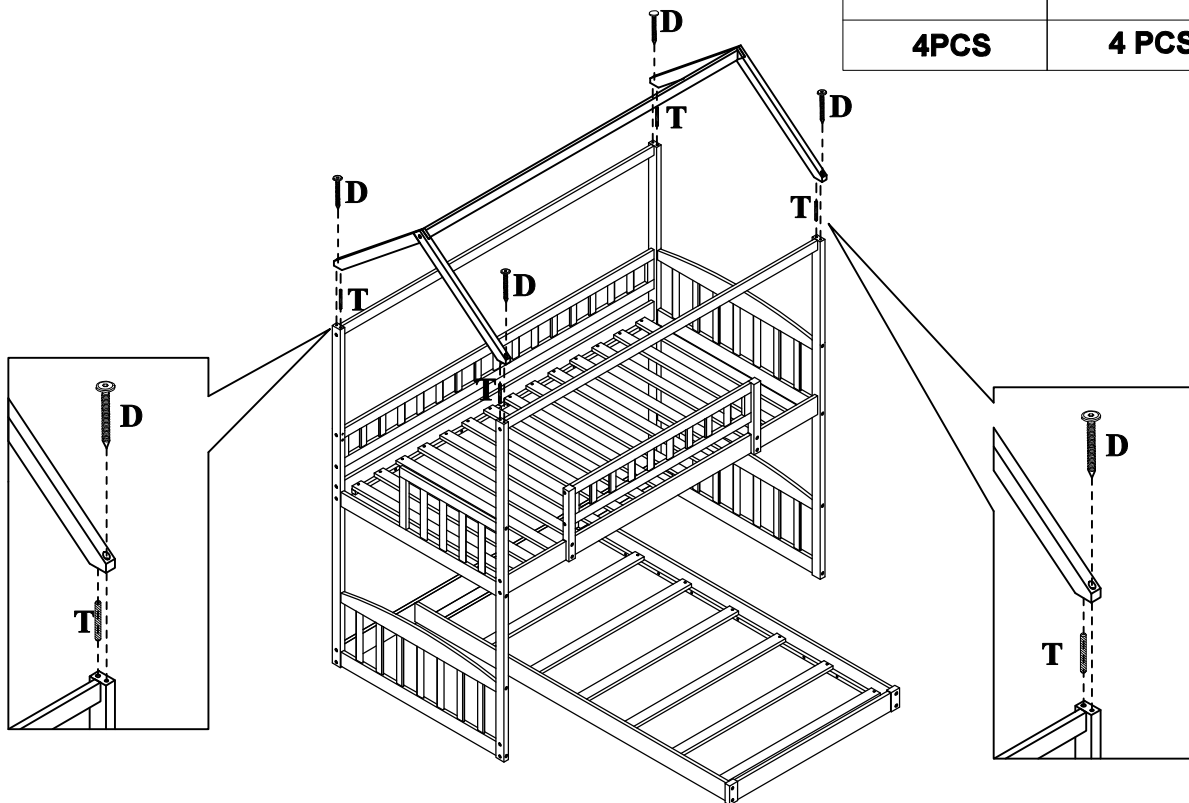

STEP: 8

D	T
	
4PCS	4 PCS



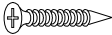
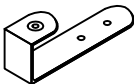

STEP: 9

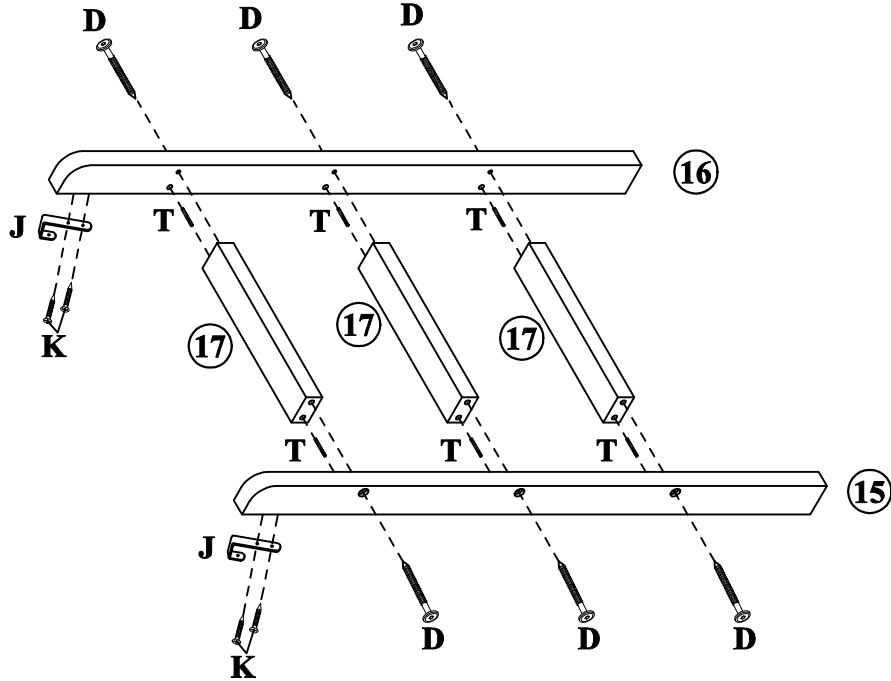
K	J	D	T
			
4PCS	2PCS	6PCS	6PCS

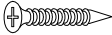
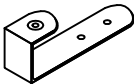

STEP: 10

K	J	D	T
			
4PCS	2PCS	16PCS	12PCS

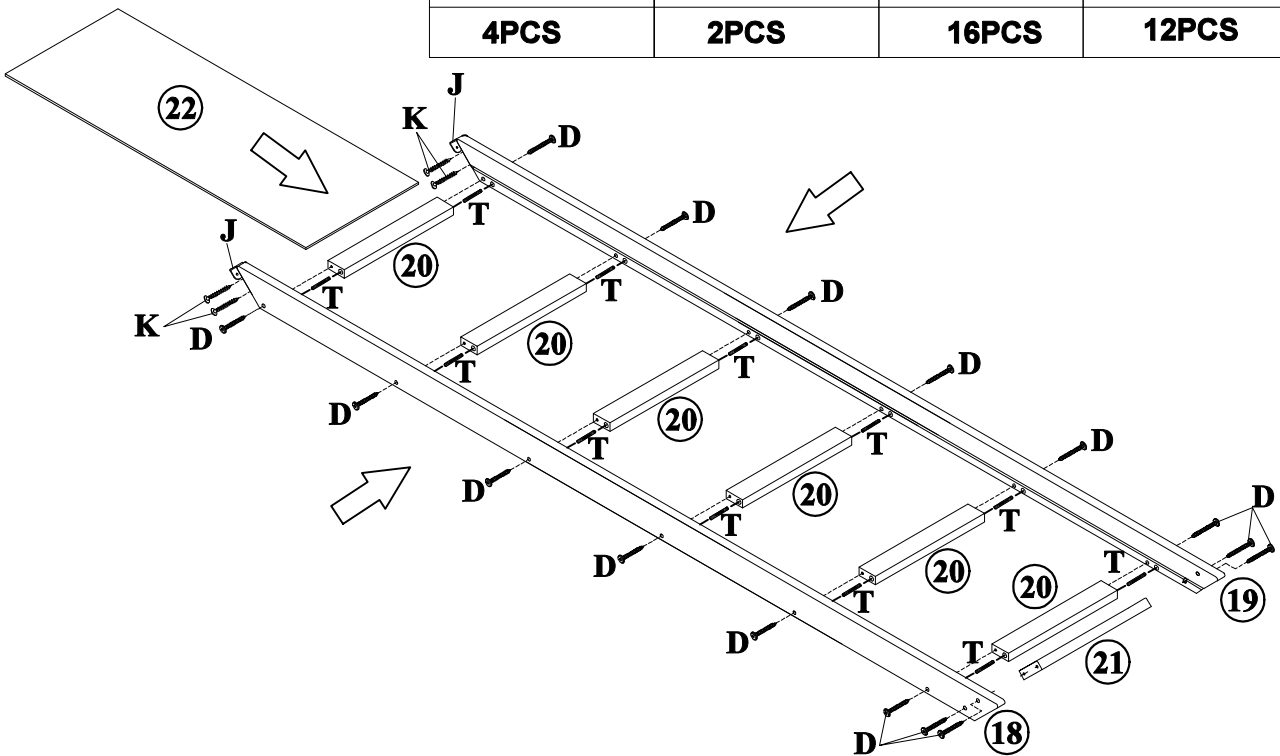

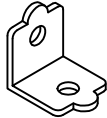
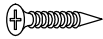
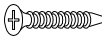

STEP: 11

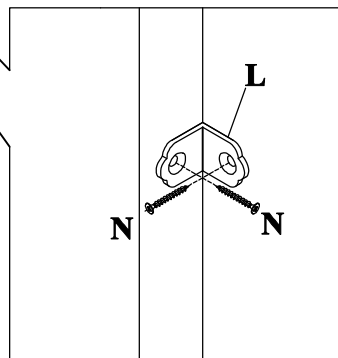
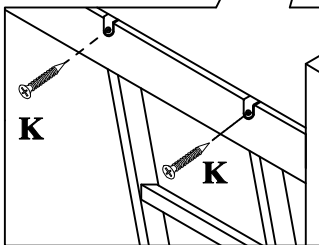
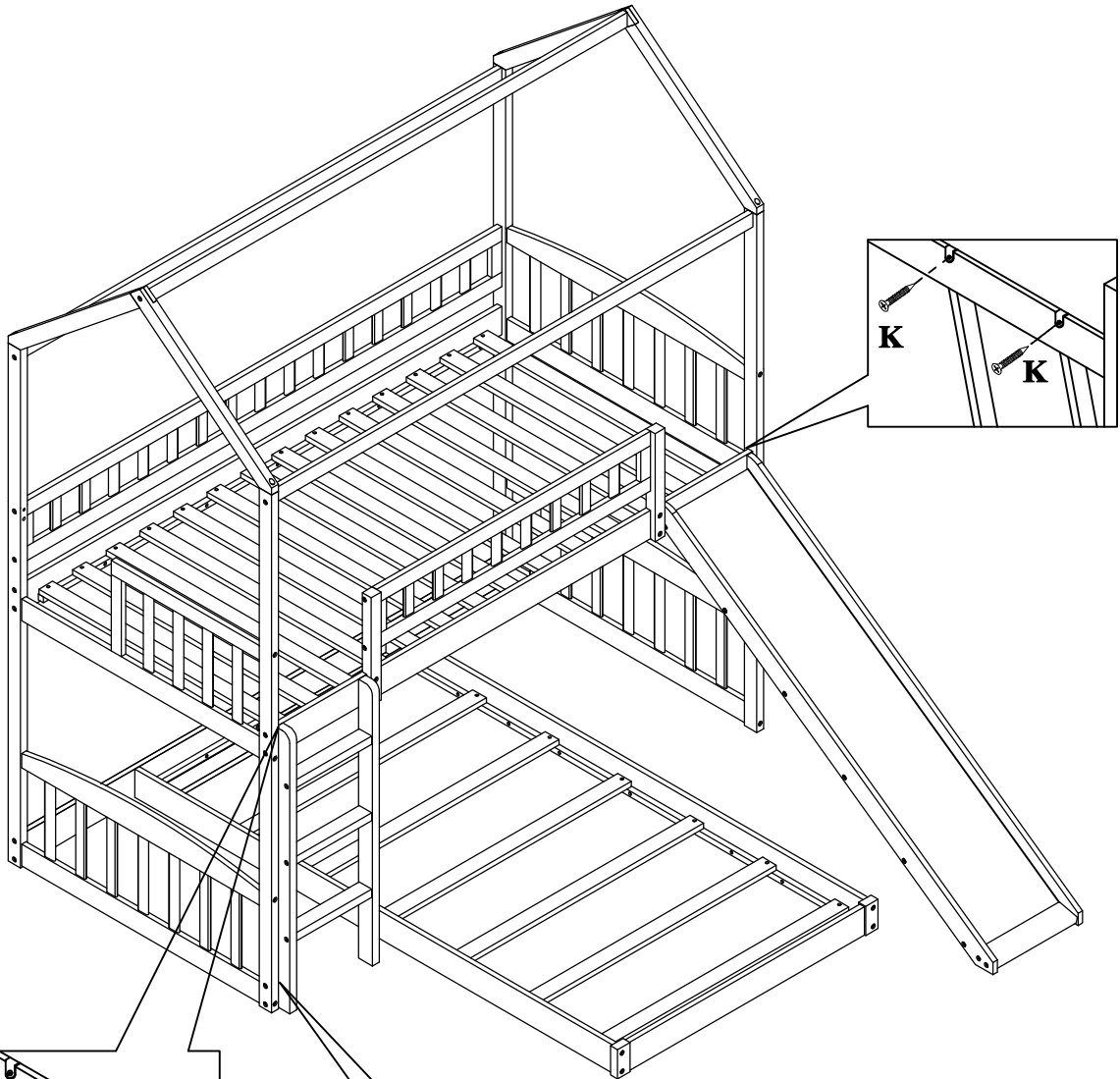
N	L		K
			
2 PCS	1 PC		4PCS



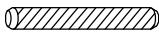

STEP: 12

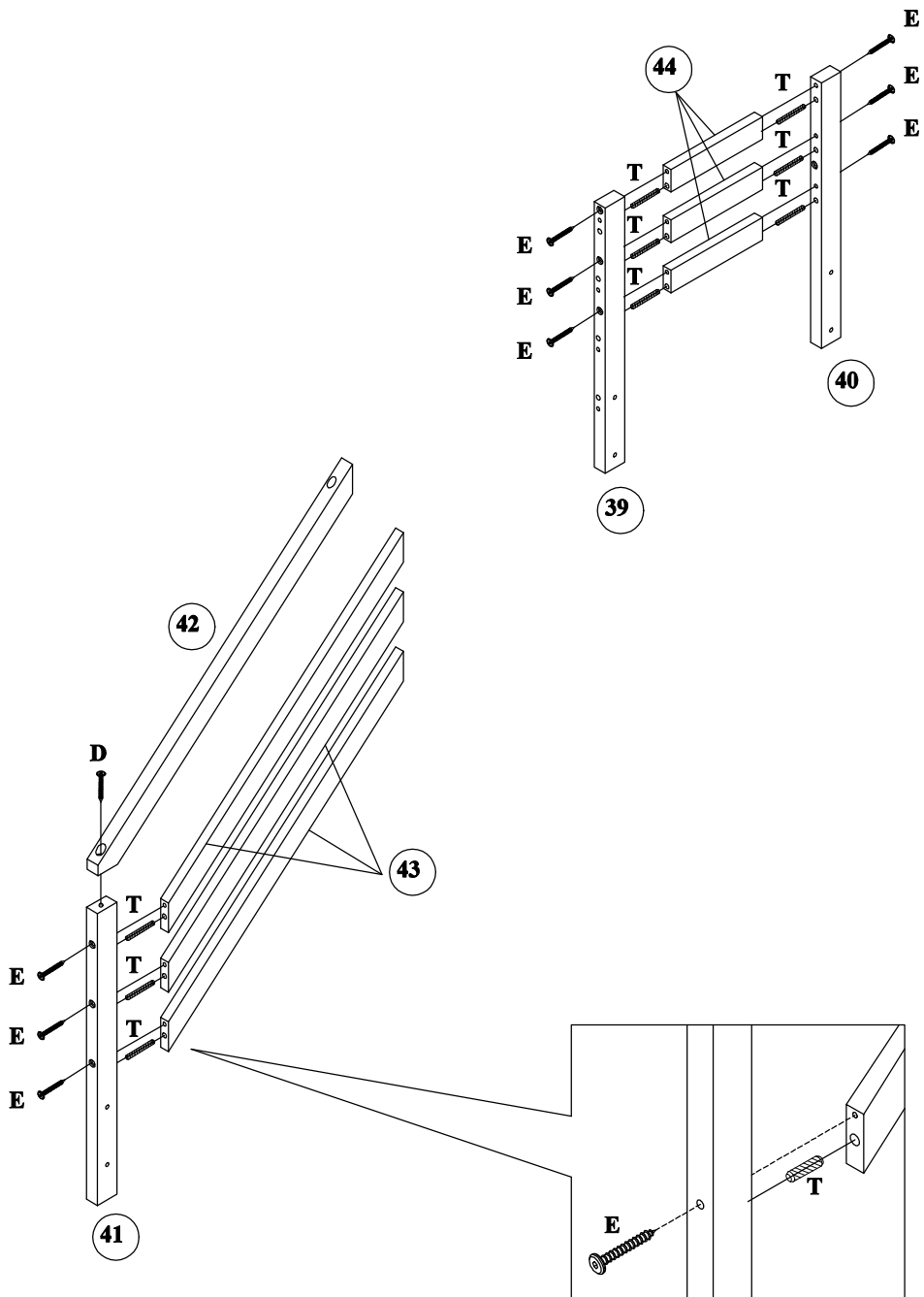
D	T	E
		
1 PCS	9 PCS	9 PCS



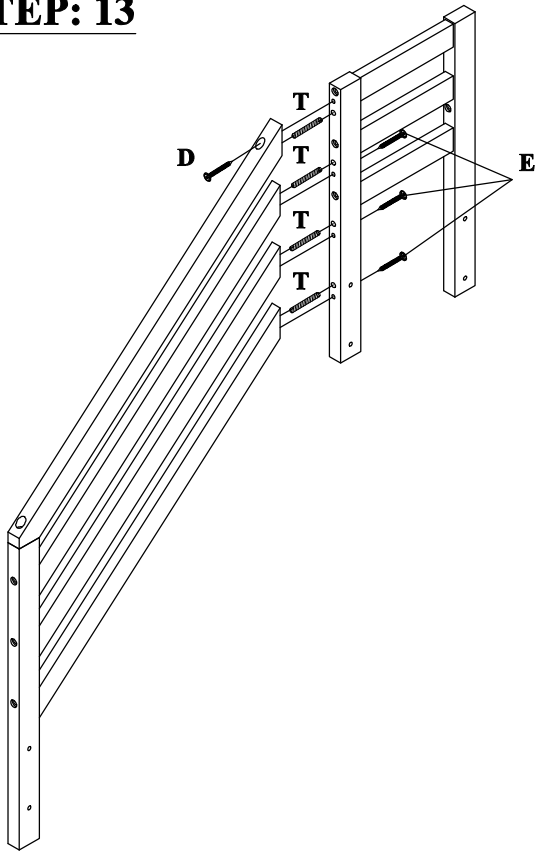

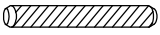
STEP: 13

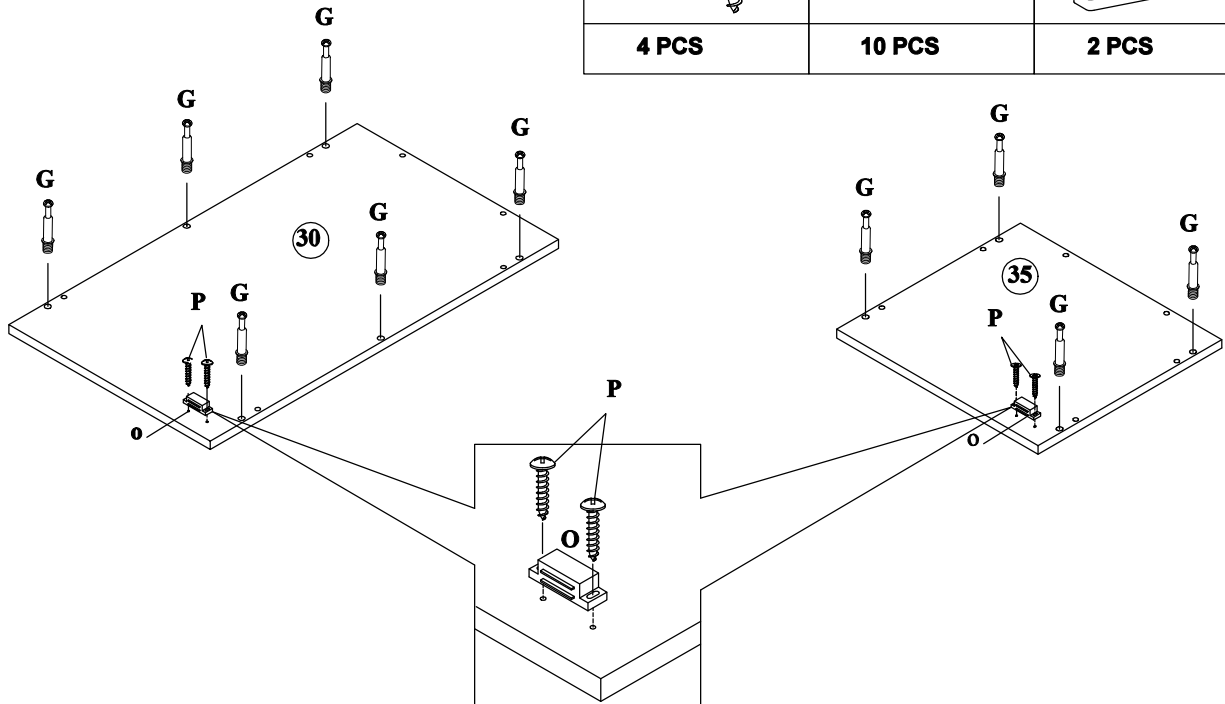

T	D	E
		
4 PCS	1 PC	3 PCS

STEP: 14

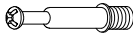
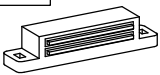

P	G	O
		
4 PCS	10 PCS	2 PCS

STEP: 15

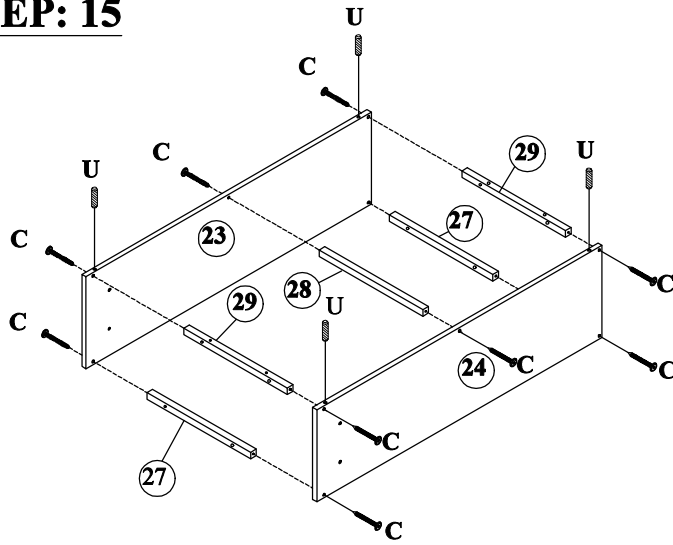

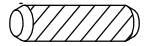
C	U
	
10 PCS	4 PCS

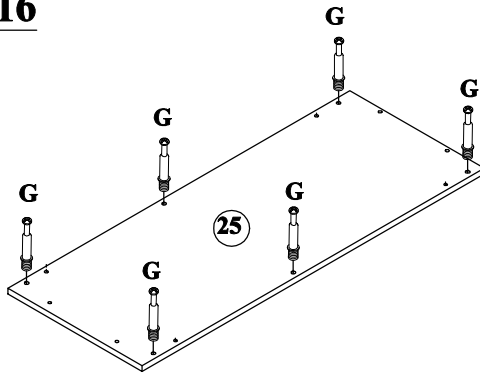

STEP: 16

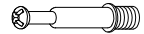

G

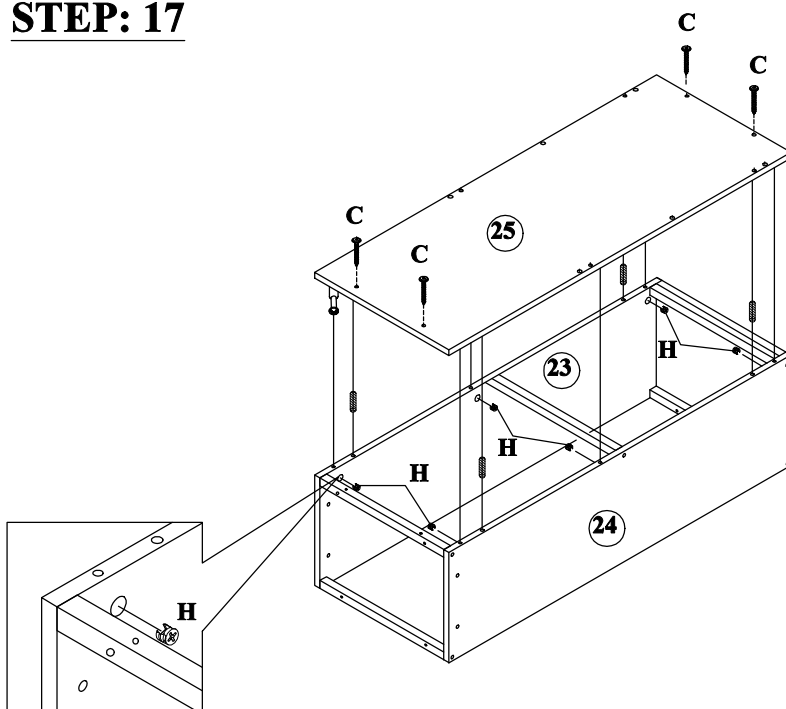
6 PCS

STEP: 17



C	H
	
4 PCS	6 PCS

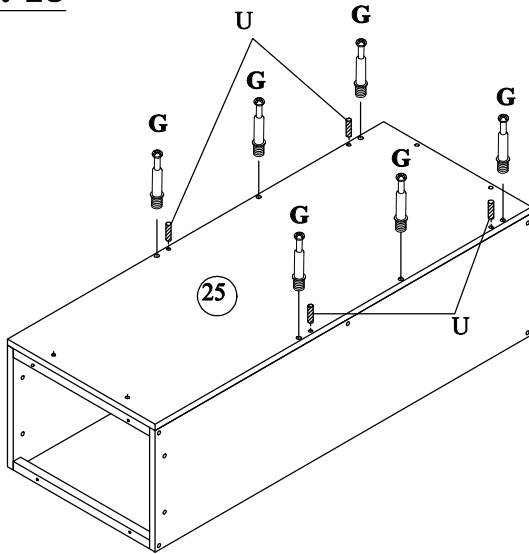

STEP: 18

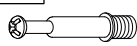
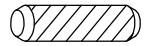

G		U	
6 PCS		4 PCS	

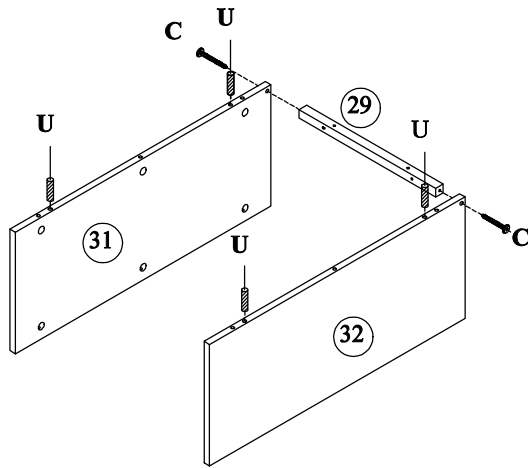
STEP: 19





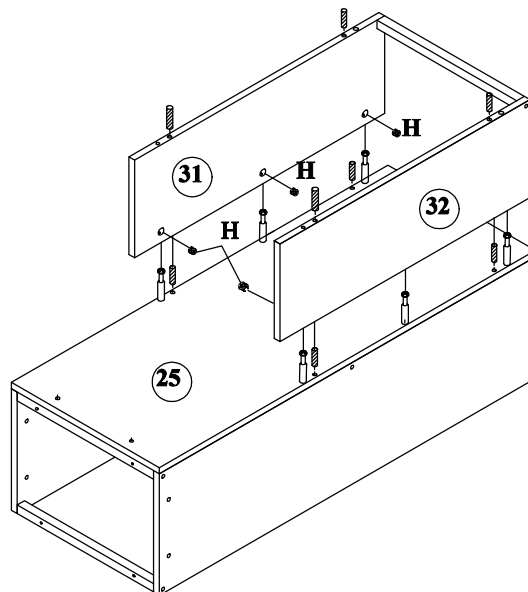

C		U	
2 PCS		4 PCS	

STEP: 20

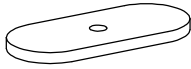

H	
6 PCS	

STEP: 21

C	H	Q	R
			
2 PCS	6 PCS	1 PC	5 PCS

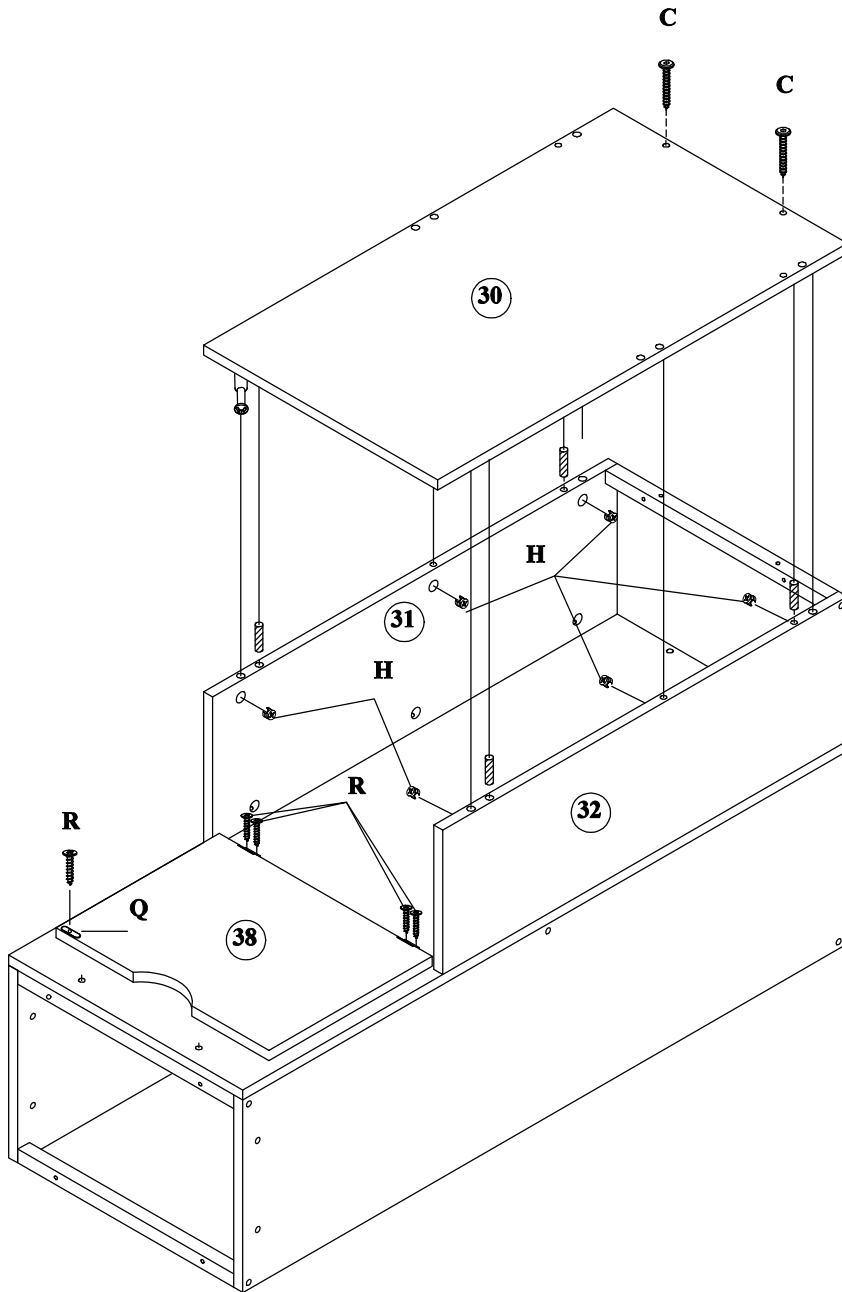

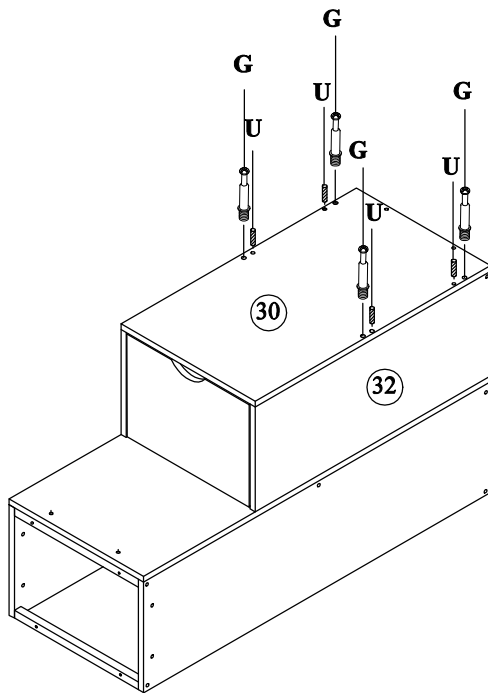

STEP: 22

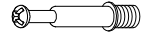

U	G
	
4 PCS	4 PCS

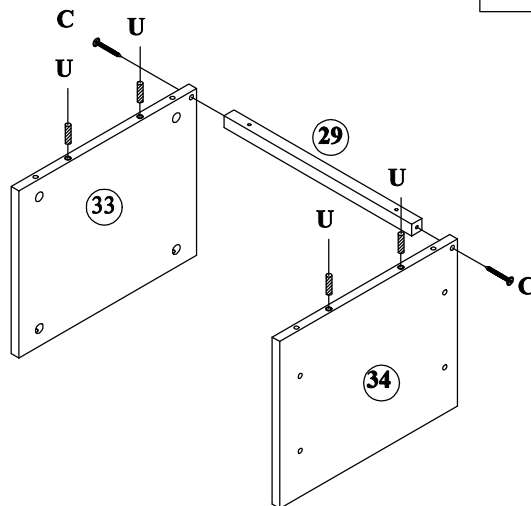
STEP: 23



C	U
	
2 PCS	4 PCS

STEP: 24





H

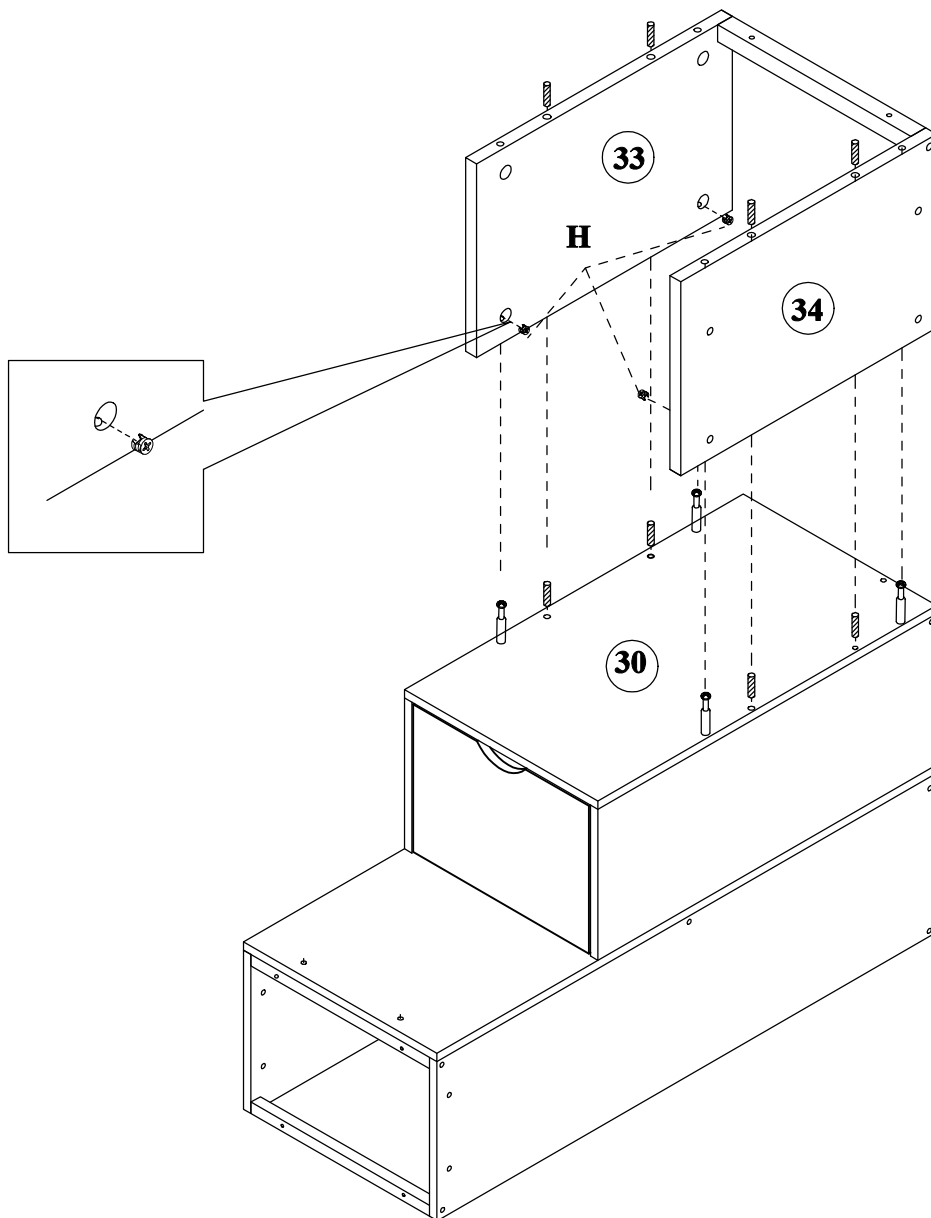

4 PCS

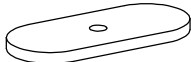

STEP: 25

C	H	Q	R
			
2 PCS	4 PCS	1 PC	5 PCS

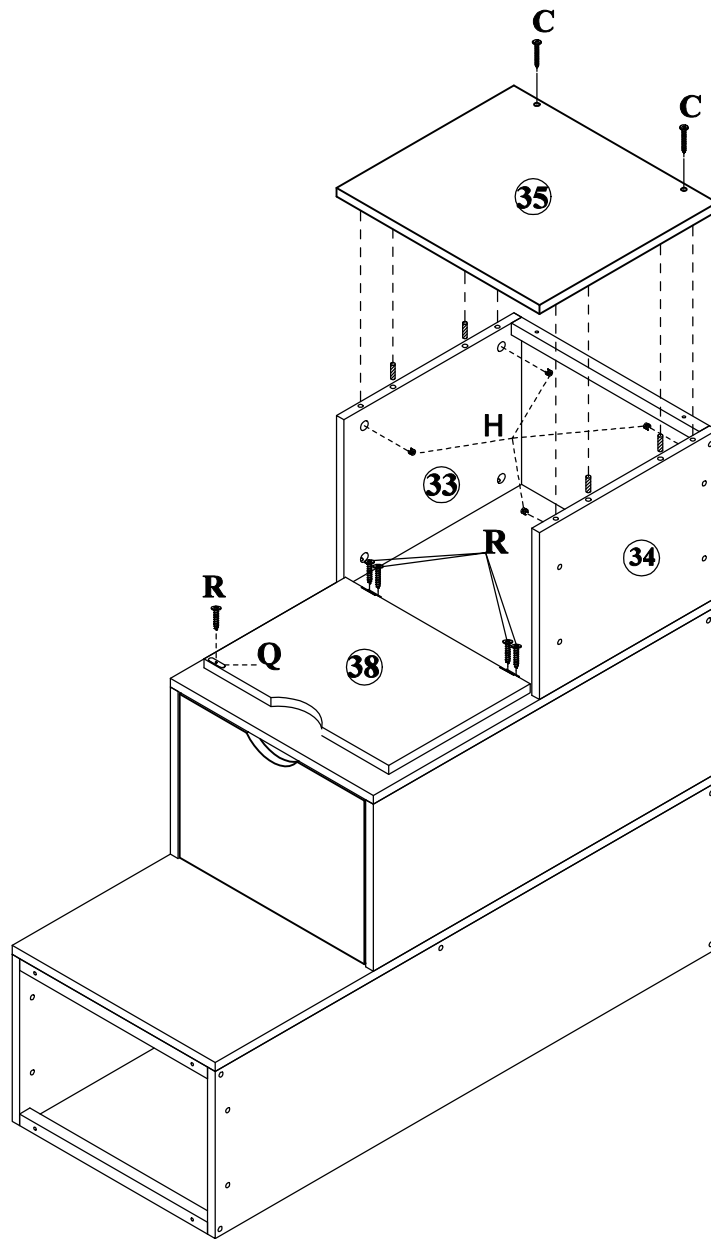

STEP: 26

C



6 PCS

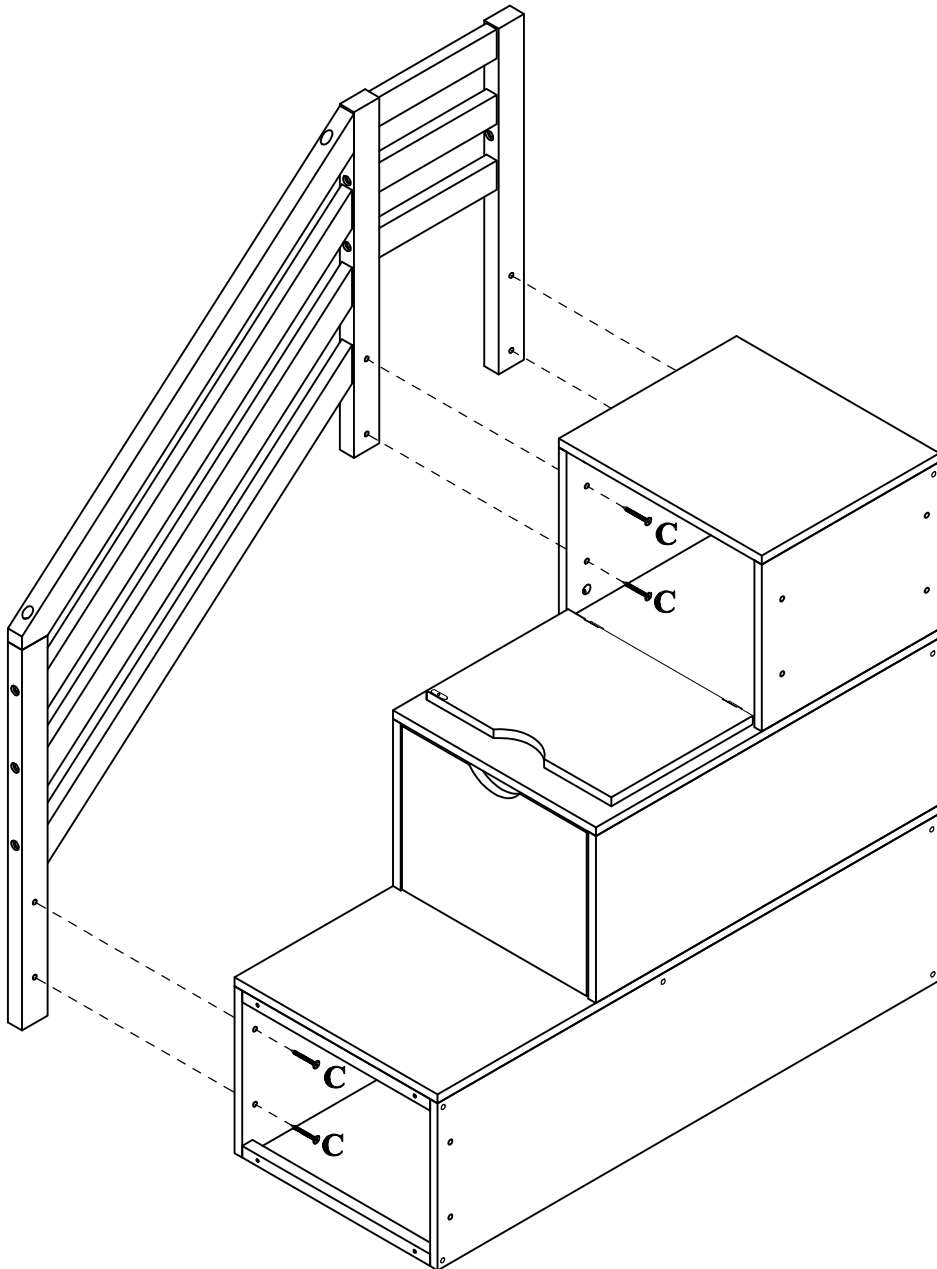

STEP: 27

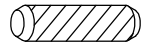
C	U
	
12 PCS	2 PCS

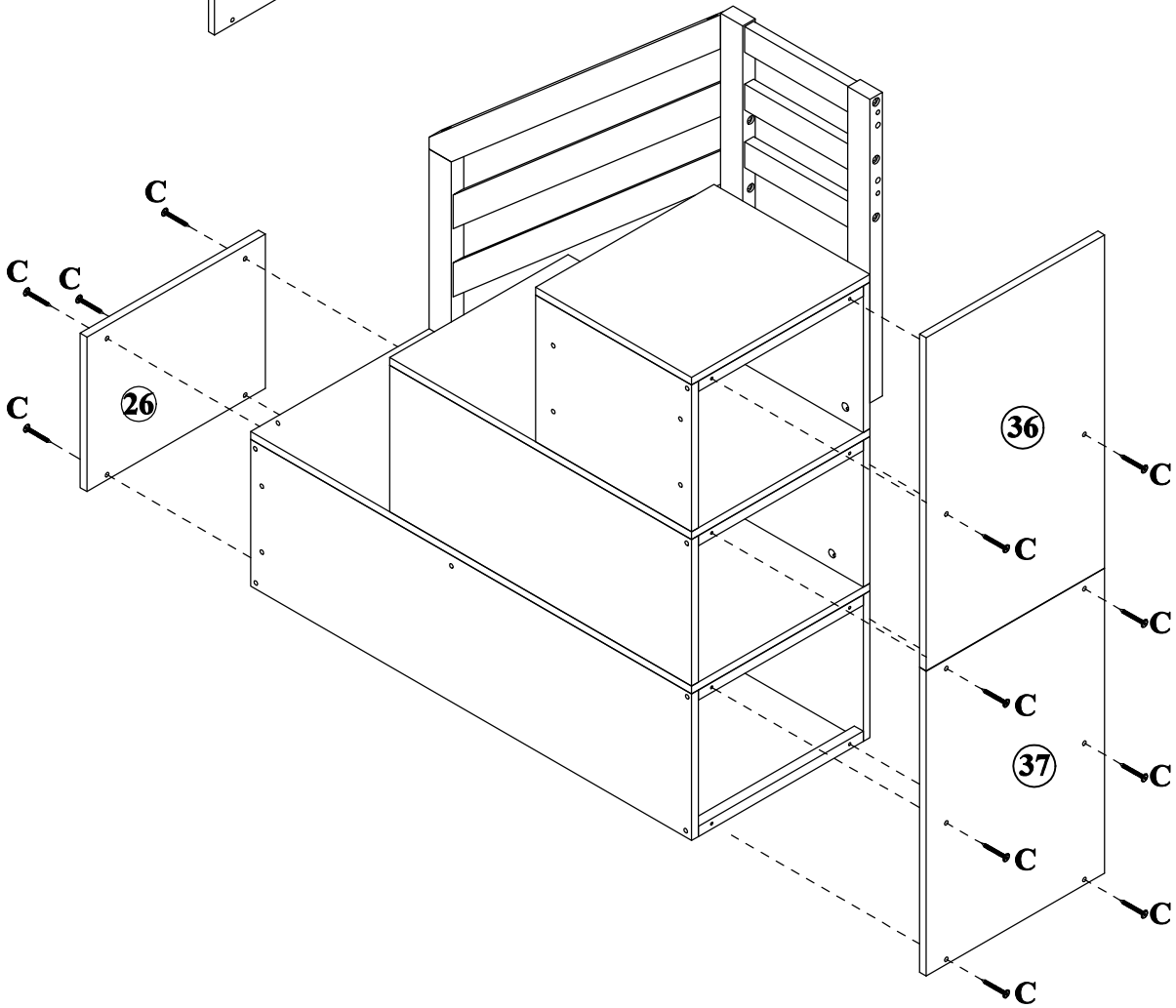
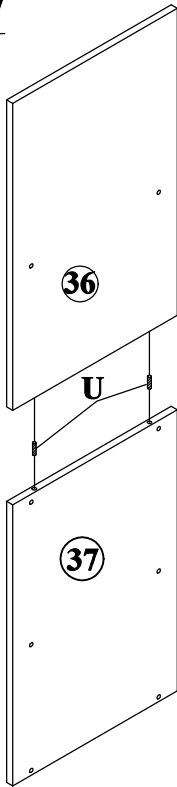

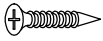

STEP: 28

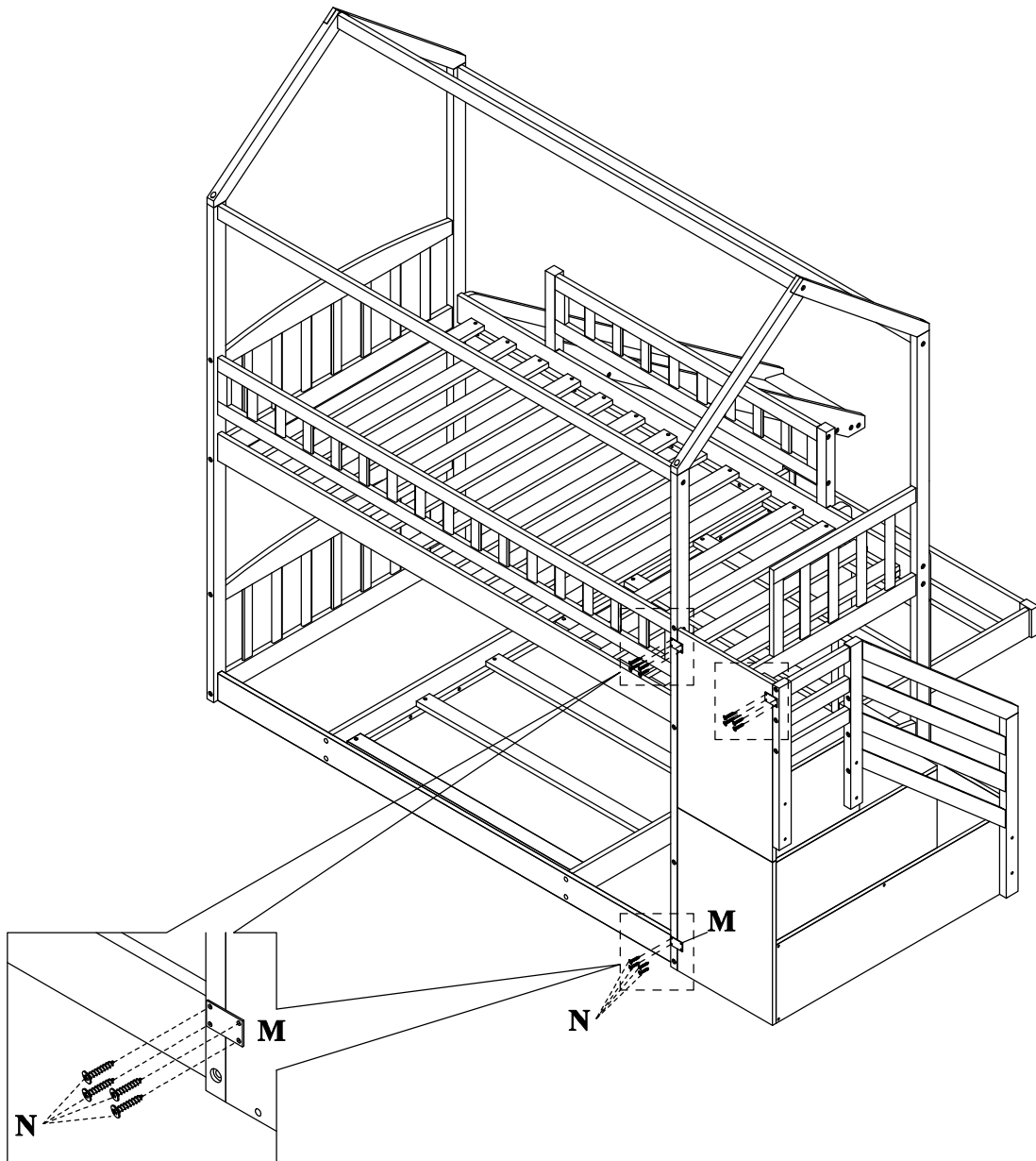
M		N	
3 PCS		12 PCS	



STEP: 29

N	L
	
2 PCS	1 PC

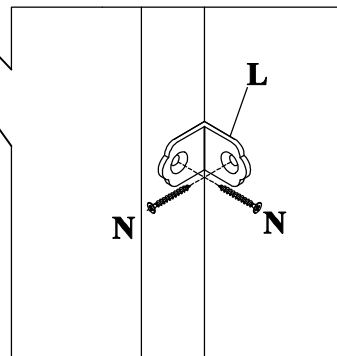
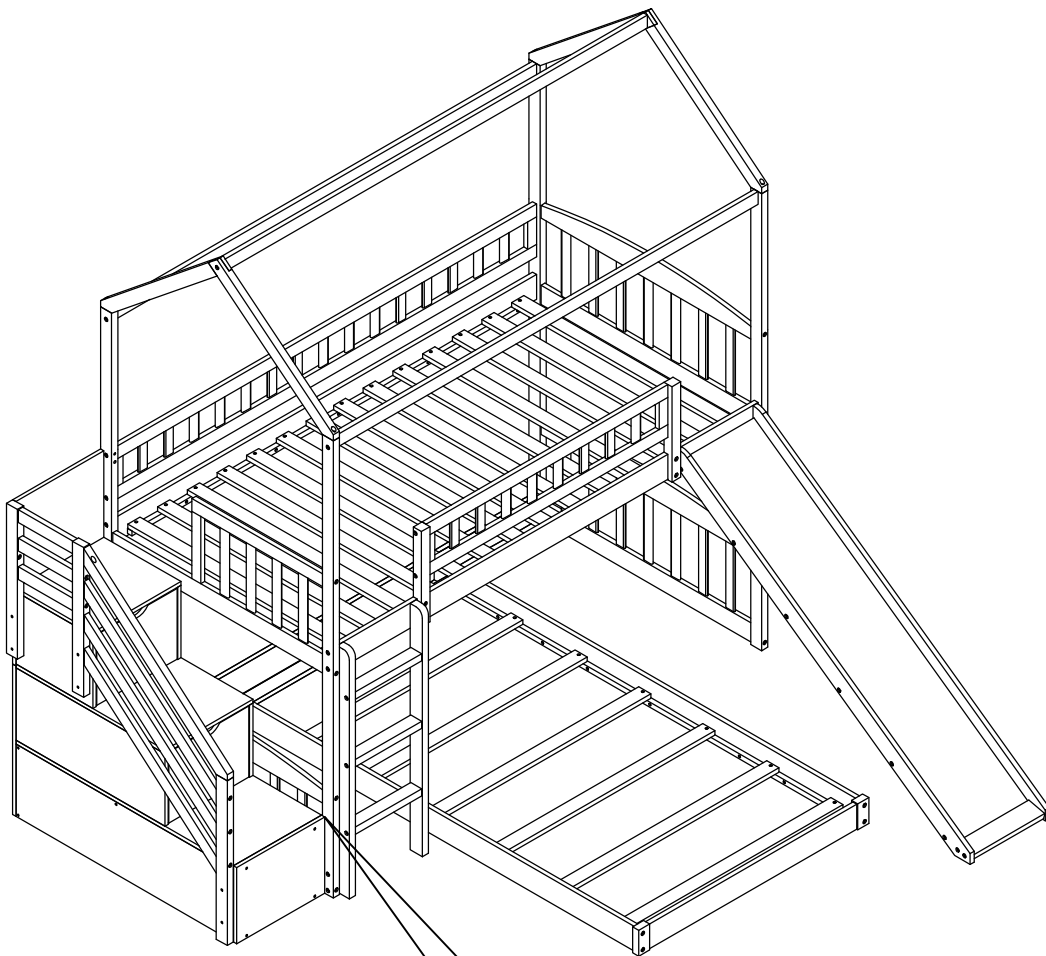

STEP:30

