



**ASSEMBLY GUIDE  
GUIDE DE MONTAGE  
GUÍA DE MONTAJE**

**URBANA**

# LARGE PARKLETTE PLANTER

GRAND PLANTEUR DE PARKLETTE

GRAN PARKLETTE PLANTER

**VT17513 / VT17613**

ESPRESSO  
EXPRESSO  
ESPRESSO

SLATE  
ARDOISE  
PIZARRA

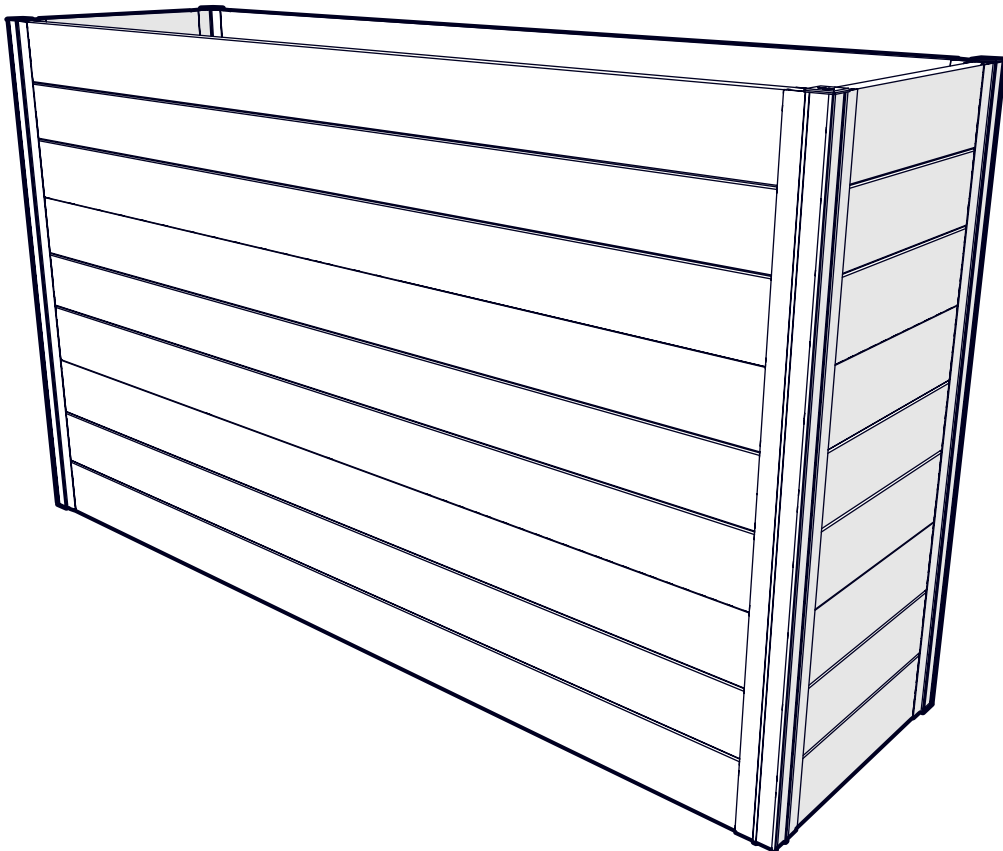

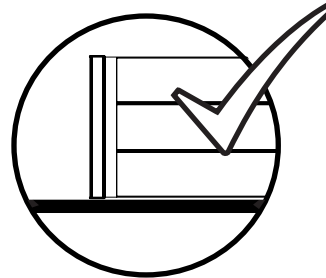
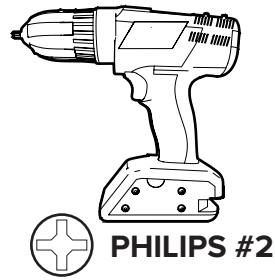
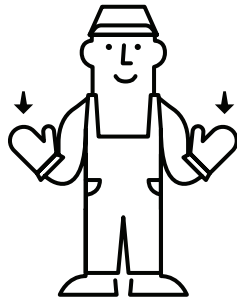
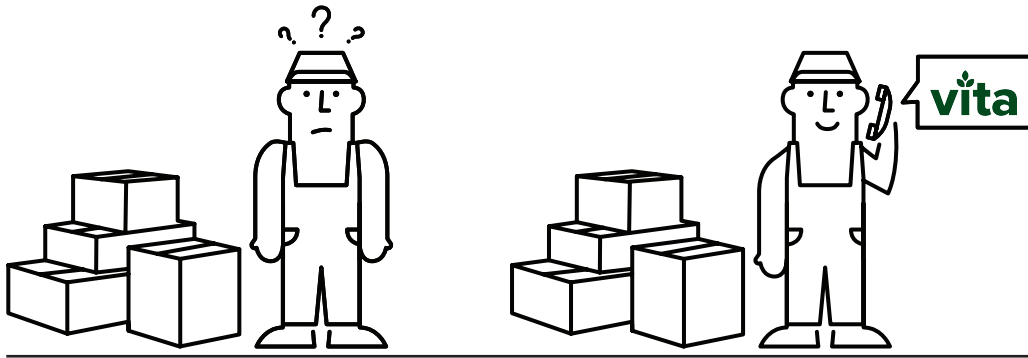

 1-800-282-9346



HELLO@WEAREVITA.COM



WWW.WEAREVITA.COM



8:00 AM - 5:00 PM EST



# PARTS LIST

# LISTE DES PIÈCES

# LISTA DE PARTES



**16030** - SLATE - ARDOISE - PIZARRA  
**15030** - ESPRESSO - EXPRESSO - ESPRESSO  
**BOARD A** - PLANCHE A - TABLERO A  
54 1/2IN (138.4CM) - **X2**

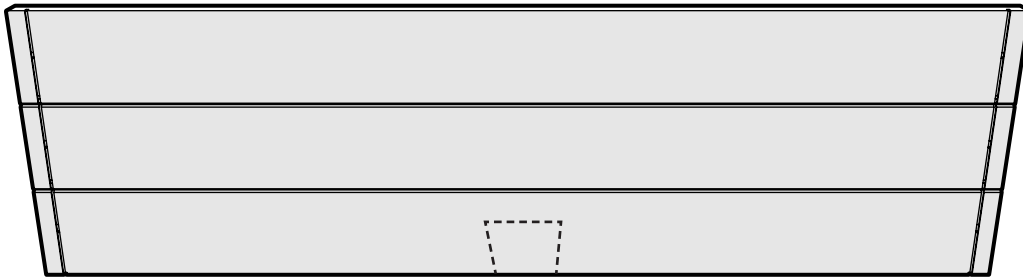

**16148** - SLATE - ARDOISE - PIZARRA  
**15148** - ESPRESSO - EXPRESSO - ESPRESSO  
**BOARD B** - PLANCHE B - TABLERO B  
54 1/2IN (138.4CM) - **X4**



**16022** - SLATE - ARDOISE - PIZARRA  
**15022** - ESPRESSO - EXPRESSO - ESPRESSO  
**BOARD C** - PLANCHE C - TABLERO C  
13 5/8IN (34.7CM) - **X6**



**16031** - SLATE SLATE - ARDOISE - PIZARRA  
**15031** - ESPRESSO - EXPRESSO - ESPRESSO  
**FLOOR BRACE** - BRACE DE PLANCHER - BRACE DE PISO  
54 1/2IN (138.4CM) - **X2**



**16028** - SLATE - ARDOISE - PIZARRA  
**15028** - ESPRESSO - EXPRESSO - ESPRESSO  
**CROSS BRACE** - ENTRETOISE - BRAZO CRUZADO  
13 3/4IN (35.2CM) - **X1**

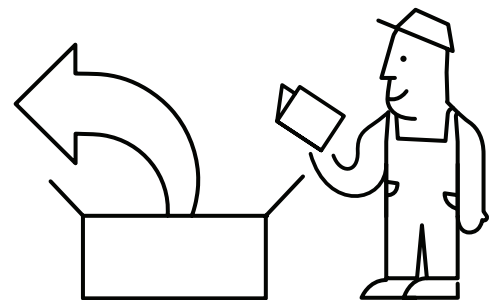

**PARTS NOT TO SCALE PIÈCES NON À L'ÉCHELLE PARTES NO A ESCALA**



**16032** - SLATE - ARDOISE - PIZARRA  
**15032** - ESPRESSO - EXPRESSO - ESPRESSO  
**FLOOR BOARD D** - PLANCHE D'ÉTAGE D - TABLERO DE PISO D  
 14IN (35.8CM) - **X2**



**16033** - SLATE SLATE - ARDOISE - PIZARRA  
**15033** - ESPRESSO - EXPRESSO - ESPRESSO  
**FLOOR BOARD E** - PLANCHE D'ÉTAGE E - TABLERO DE PISO E  
 14IN (35.8CM) - **X3**

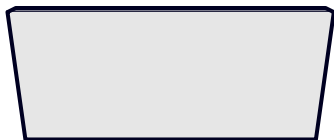

**16067**  
**LOCKING TAB** - ONGLET DE VERROUILLAGE - PESTAÑA DE BLOQUEO  
**X2**



**16325**  
**POST CAP** - ETE DE POTEAU - TABLERO DE PISO  
 1 1/4" (3.2 CM) - **X8**



**16029**  
**POST F** - PUBLIER F - EXPONER F  
 33" (83.7 CM) - **X2**



**16044**  
**POST G** - PUBLIER G - EXPONER G  
 33" (83.7 CM) - **X2**

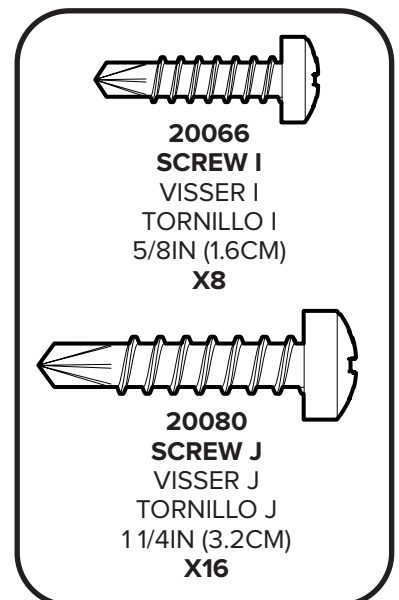

**PARTS NOT TO SCALE PIÈCES NON À L'ÉCHELLE PARTES NO A ESCALA**

# PRODUCT DIMENSIONS

DIMENSIONS DU PRODUIT

DIMENSIONES DEL PRODUCTO

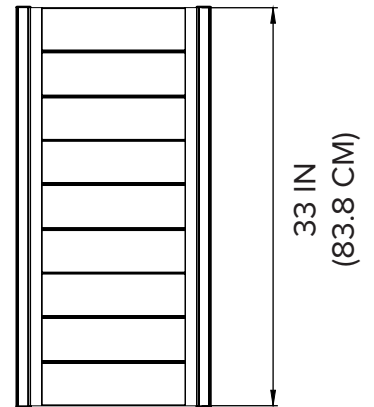
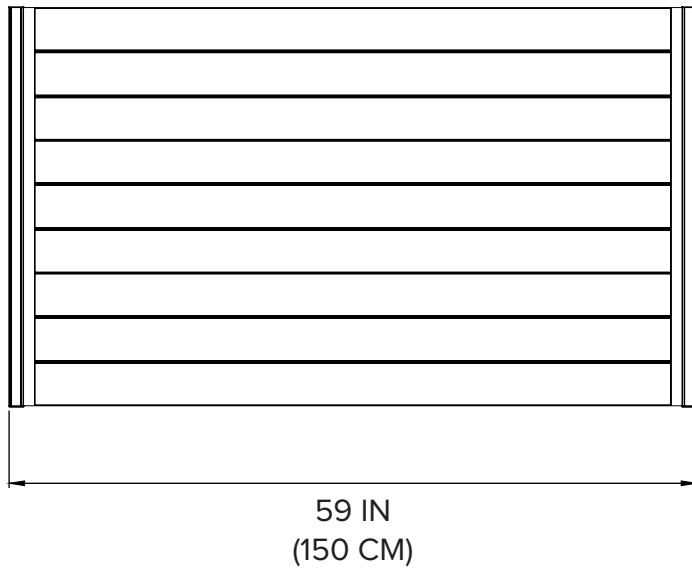
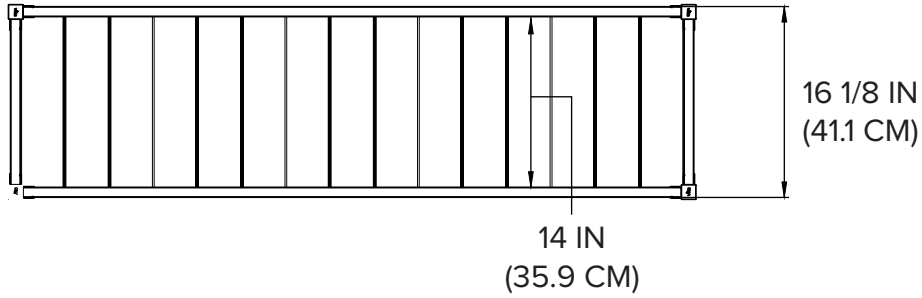

False Bottom	Depth	Soil Capacity	Bags of Soil
①	8 5/8" (22.1cm)	4.0 cubic feet (113.0 liters)	x4
②	14 5/8" (37.3cm)	6.8 cubic feet (191.8 liters)	x7
③	21 5/8" (52.5cm)	10.0 cubic feet (283.7 liters)	x10

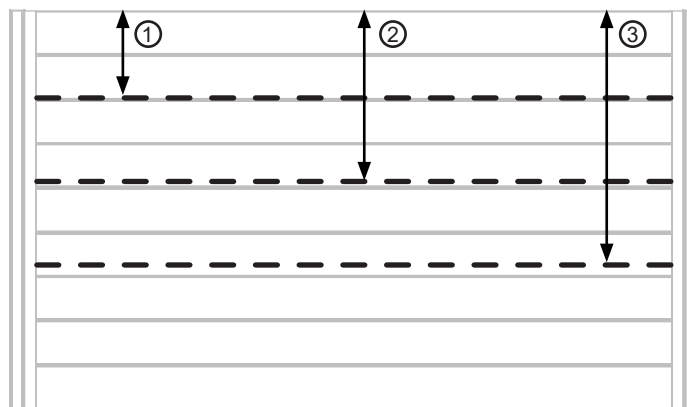

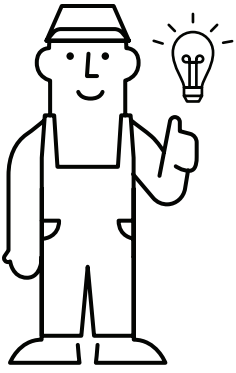

**THESE THREE SCREW HOLES ALLOW YOU TO POSITION YOUR FLOOR BRACE AT DIFFERENT DEPTHS. CHOOSE YOUR DEPTH ACCORDING TO WHAT YOU WILL BE PLANTING AND HOW MUCH SOIL IS NEEDED!**

**CES TROIS TROUS DE VIS VOUS PERMETTENT DE POSITIONNER VOTRE CONTREVENTEMENT À DIFFÉRENTES PROFONDEURS. CHOISISSEZ VOTRE PROFONDEUR EN FONCTION DE CE QUE VOUS ALLEZ PLANTER ET DE LA QUANTITÉ DE TERRE NÉCESSAIRE!**

**ESTOS TRES ORIFICIOS PARA TORNILLOS LE PERMITEN COLOCAR LA RIOSTRA DEL PISO A DIFERENTES PROFUNDIDADES. ¡ELIJA SU PROFUNDIDAD DE ACUERDO CON LO QUE VA A PLANTAR Y LA CANTIDAD DE TIERRA QUE SE NECESITA!**

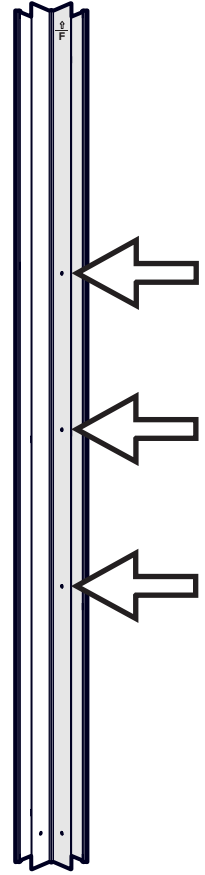

- 16030/15030 - x2 (A)
- 16148/15148 - x4 (B)
- 16067 - x2
- 16029 - x2 (F)
- 16044 - x2 (G)

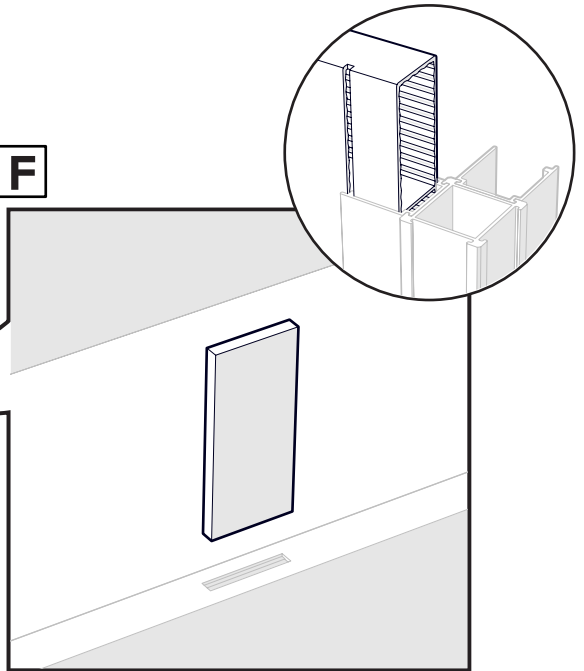
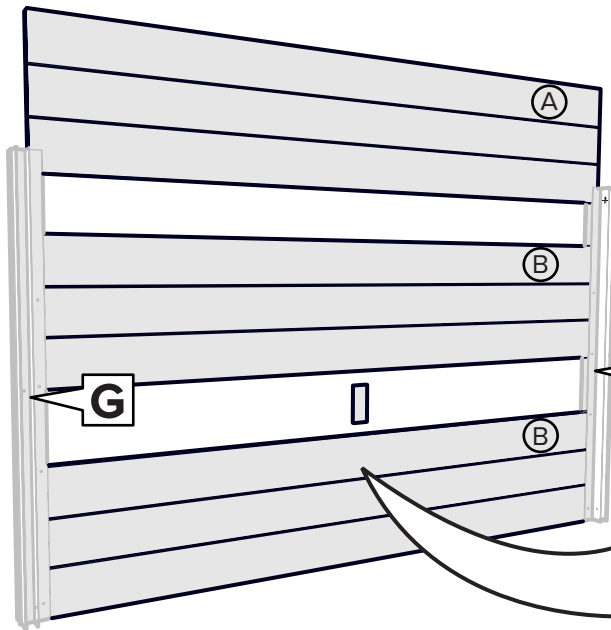

**X2**



# 2

20066 - x4 ① 

20080 - x8 ② 

16031/15031 - x2 

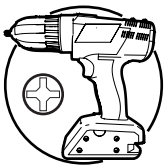
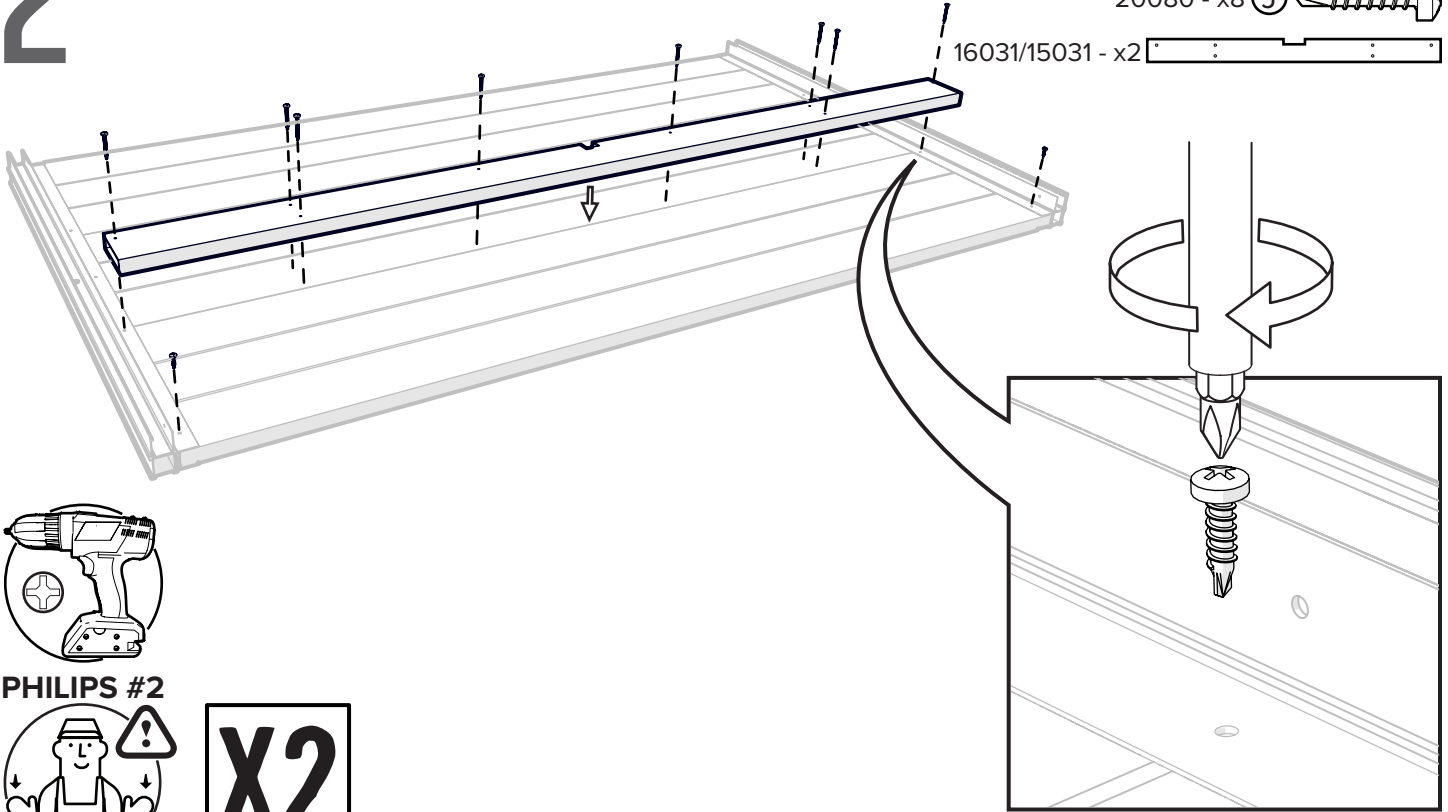

PHILIPS #2



# X2

# 3

16022/15022 - x6 ③ 

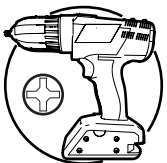
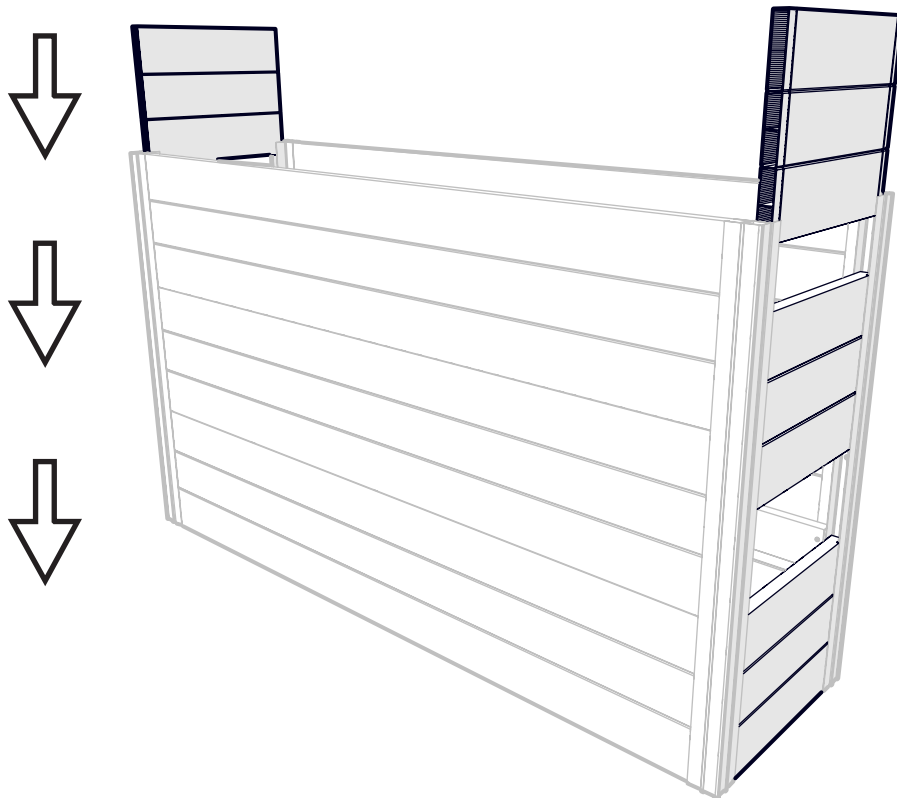

PHILIPS #2



# 4

20066 - x4 

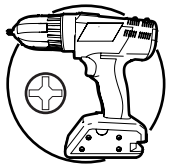
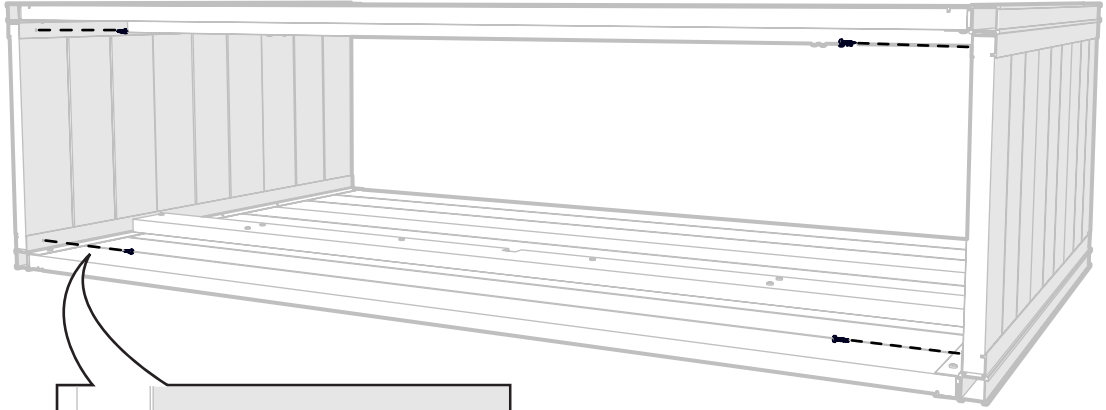

PHILIPS #2

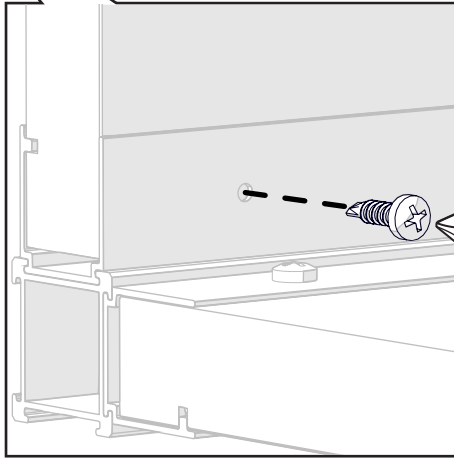

16028/15028 - x1

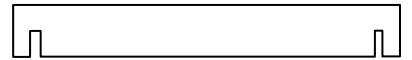

# 5

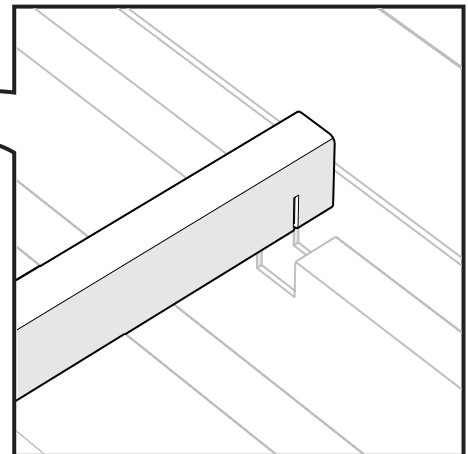
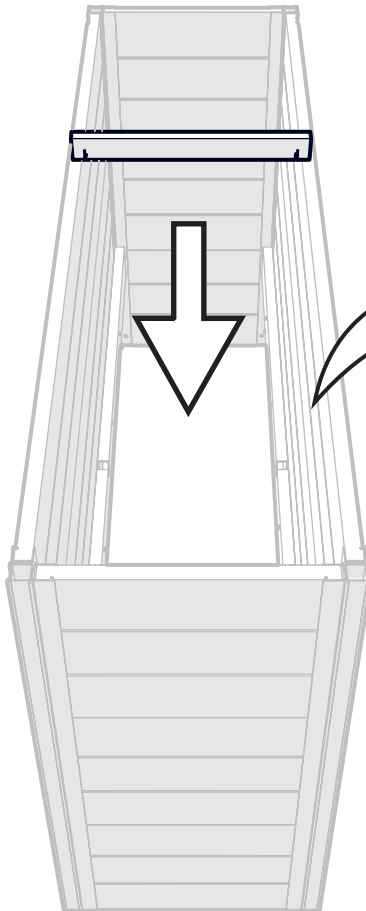



# 6



16032/15032 - x2 (D)

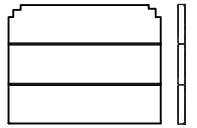

16033/15033 - x3 (E)

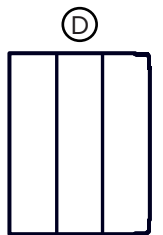
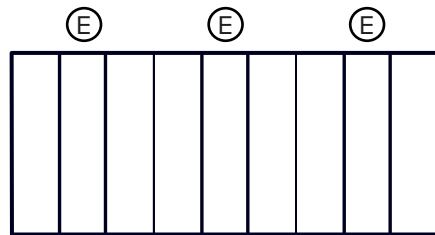
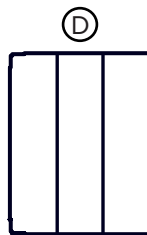

# 7



16325 - x4



VT17525/VT17625 →

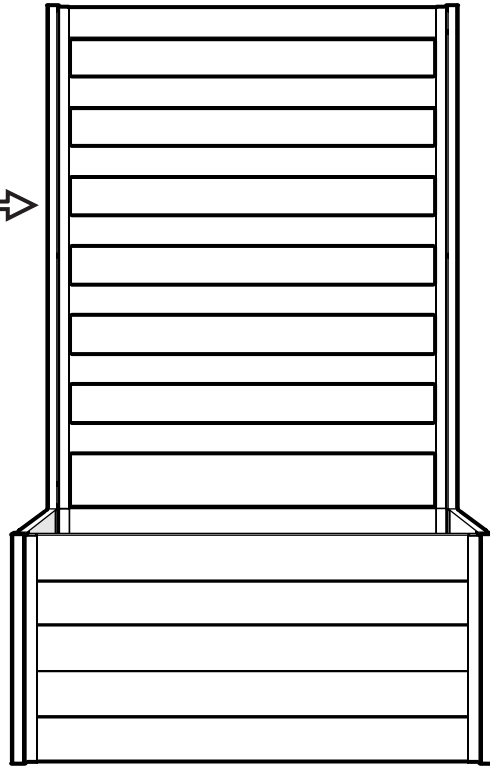

VT17512/VT17612 ⇨

## ADD A TRELLIS!

AJOUTER UN TREILLIS!  
AGREGAR UN ENREJADO!  
FÜGEN SIE EIN GITTER HINZU  
AGGIUNGI UN TRALICCIO

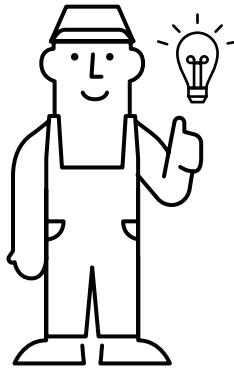

## COMBINE PARKLETTES AND TRELLIS

COMBINEZ PARKLETTES ET TREILLIS  
COMBINA PARKLETTES Y TRELLIS  
KOMBINIEREN SIE PARKLETTES UND SPALIER  
COMBINA PARKLETTES E TRELLIS

VT17524/  
VT17624

VT17525/  
VT17625



VT17513/  
VT17613



VT17512/  
VT17612

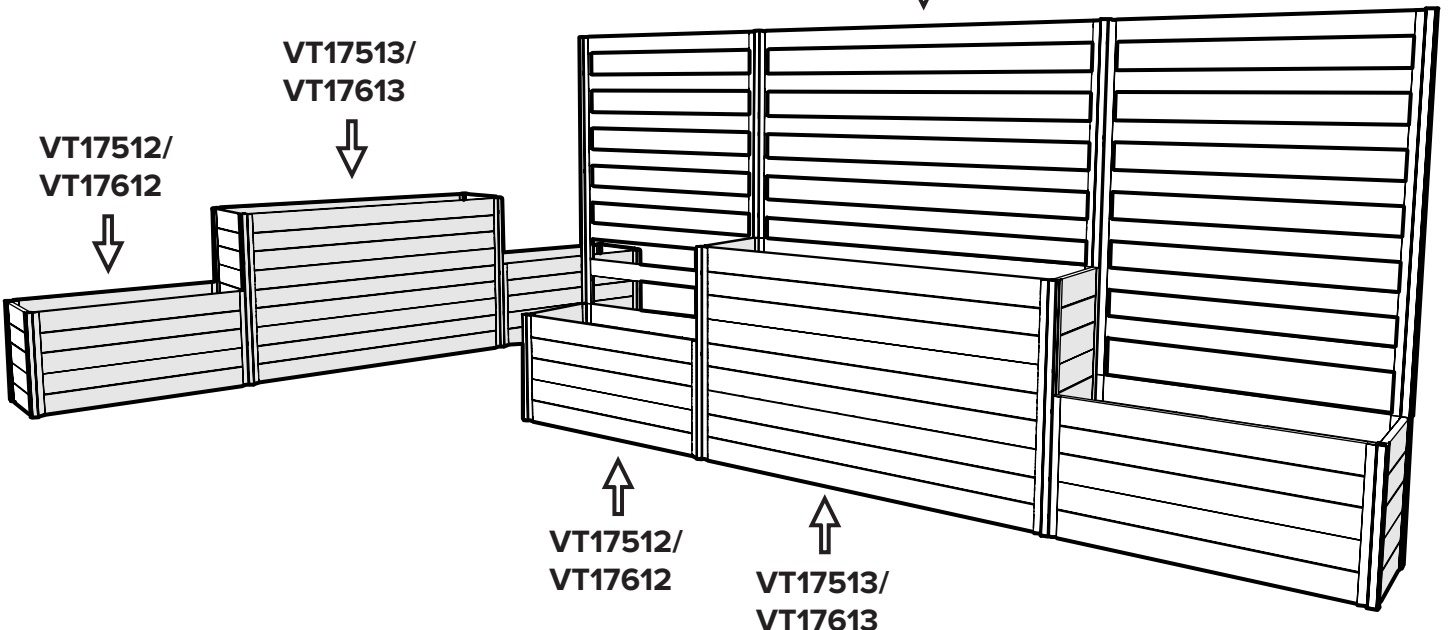

↑  
VT17512/  
VT17612

↑  
VT17513/  
VT17613