

PART NO. D12108

SPECIFICATION SHEET

Brass 1/2 in. IPS Nipple

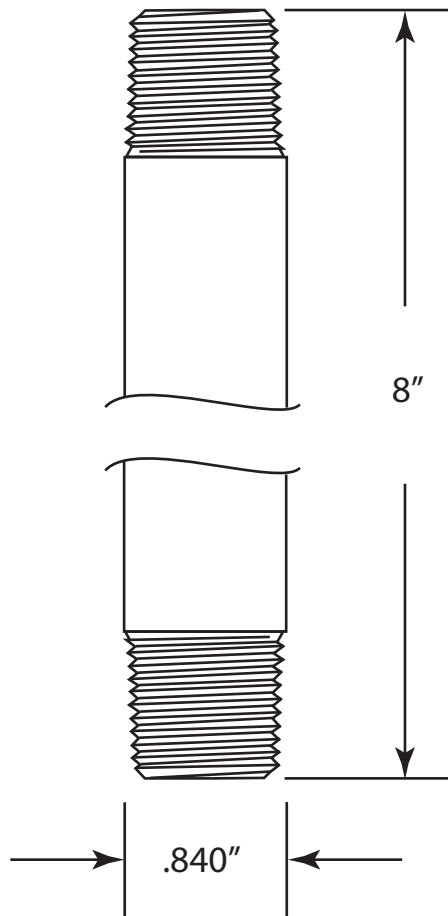

0.109" Wall  
Thickness

