

### Features

- Includes face plate with handle.
- Single handle controls both on/off activation and temperature setting.
- Supplied with ADA compliant metal lever handle.
- Complements the Finial faucet and accessory collections.

### Material

- Premium material construction with metal handle ensures reliability and durability.
- KOHLER finishes resist corrosion and tarnishing, exceeding industry durability standards.

### Installation

- Trim set requires valve to complete installation.

### Required Accessories

K-304/K-P304 Series Rite-Temp® Valves

or

K-8304/K-P8304 Series Rite-Temp® Valve & Cartridge Kits

or

K-8300/K-P8300 Series Rite-Temp® Valve Body Rough-ins

K-8305/K-P8305 Series Rite-Temp® Cartridges

or

K-2971-KS 3/4" Pressure-balancing Valve

### Optional Accessories

K-10350 Deep Rough-In Kit For K-8305 Cartridges

K-10351 Test Cap For K-8300 Series Valve Bodies



ADA

CSA B651

OBC

### Codes/Standards

ASME A112.18.1/CSA B125.1

ADA

ICC/ANSI A117.1

CSA B651







OBC

### KOHLER® Faucet Lifetime Limited Warranty

See website for detailed warranty information.

### Available Color/Finishes

*Color tiles intended for reference only.*

Color	Code	Description
	CP	Polished Chrome
	SN	Vibrant® Polished Nickel
	AF	Vibrant® French Gold
	BN	Vibrant® Brushed Nickel
	BV	Vibrant® Brushed Bronze
	2BZ	Oil-Rubbed Bronze

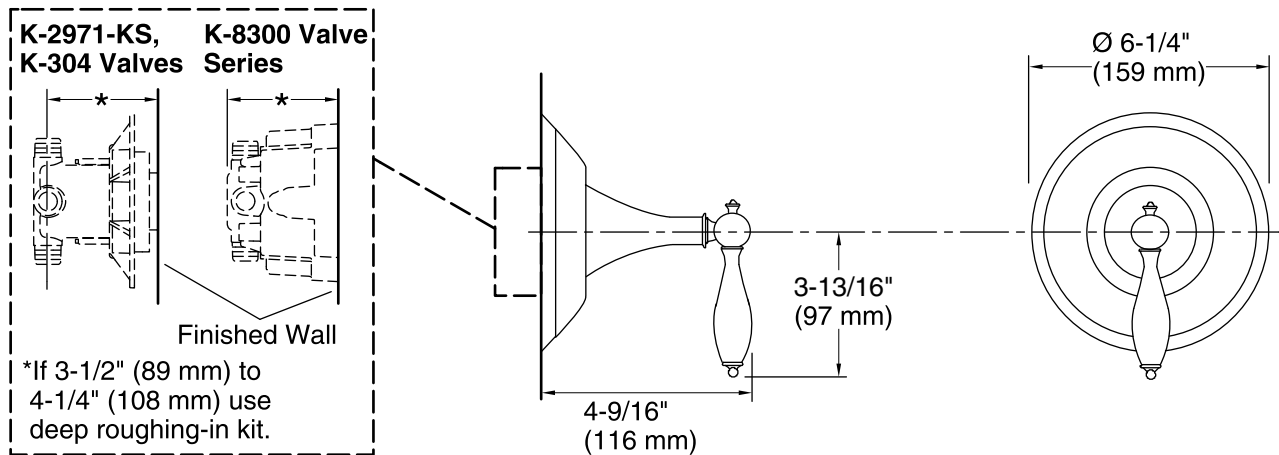

### Technical Information

All product dimensions are nominal.

### Notes

Install the product according to the installation guide.

NOTICE: Risk of product damage. Long screws for installing trim can damage the K-2971-KS valve. Consult the trim installation guide to verify if the thin wall installation kit (88526) is needed.

ADA, OBC, CSA B651 compliant when installed to the specific requirements of these regulations.