

Welcome to RibbonFlex Pro® LED Tape Lighting

Ultra thin and flexible, RibbonFlex Pro® white LED lighting is easy to install in straight, curved and irregular spaces – offering virtually limitless design and installation possibilities. Using high performance solid state lighting technology, light output, color accuracy and LED brightness are exceptional. Fully dimmable and designed to cast a seamless glow, RibbonFlex Pro creates warm and relaxing environments or delivers bright task lighting.

120 White LEDs per meter (36 LEDs per foot), model # RF3528120

Good, all-around solution for accent lighting and lower brightness task lighting.

- Over, under and inside cabinets, and in toe-kick areas
- Indirect lighting for coves and tray ceilings
- Edge lighting under counters and shelving perimeters
- Use in displays and bookcases
- Creative lighting for objects and artwork

Please read these guidelines completely before installing.

RibbonFlex Pro LED tape is a new and exciting type of lighting. It is important to read these guidelines completely to understand how the product works, and how it can be configured, cut to size, connected, and installed so you can design your LED lighting layout.

Installing tape lighting is an easy DIY project, however, basic wiring skills such as stripping, splicing, extending, and connecting wires are required.

This product operates on low voltage 12V DC power. 12V DC power supplies are sold separately and are available in different wattages. Some are dimmable, some are not.

Visit armacostlighting.com for additional installation tips, ideas, and latest product information.

Cut to Size

Offers unlimited lighting design options for custom installations.

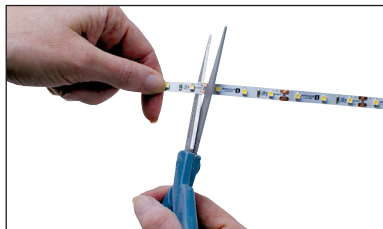

Connect with Ease

Use Armacost SureLock™ Connectors to join strips and add power wires.

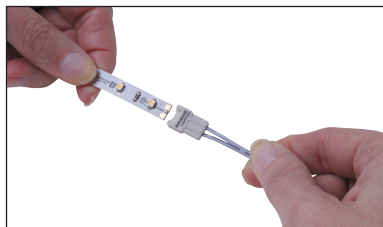

Peel and Stick

Remove 3M tan colored paper backing from LED tape lighting and stick in place.

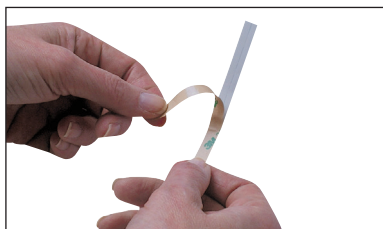

IMPORTANT

- Use only with low voltage 12V DC power source
- Do not stare directly into the LED lights when illuminated
- Do not power LED tape while coiled on reel
- Always observe polarity for 12V connections, positive (+) to positive and negative (-) to negative
- Do not install this product in areas that are susceptible to direct exposure to the elements
- Use only insulated staples, plastic ties, or wire support clips to secure cords and wires
- Route and secure wires so they will not be pinched or damaged
- For any wire runs inside of walls, use properly certified CL2 or better cabling
- Do not install Class 2 low voltage wiring in the same runs as AC main power. If AC and low voltage wires cross, keep them at 90-degree angles

All wiring must be in accordance with national and local electrical codes, low voltage Class 2 circuit. If you are unclear as to how to install and wire this product, contact a qualified professional.

Planning

RibbonFlex Pro LED lighting is designed for indirect lighting applications. The light from the LED tape is not to be seen directly by the eye. Every installation is unique and the illumination effects are personal preference. Installation location, wall colors, mounting angle, and the light's reflection off of walls, surfaces and objects will affect the final lighting appearance.

Installation considerations

- Where will you locate your power supply?
- How will you switch your LED lighting on and off?
- What is the best layout configuration for your installation?
- How will you run and conceal the wires to your LED tape lighting?



Temporarily mounting the LED light strip using painter's tape allows you to experiment with tape light positioning before permanent installation.

Important: Using painter's tape or masking tape, temporarily place the LED light strip into your desired mounting position. Power on the LEDs to make sure you are achieving the desired lighting effect before removing the 3M paper backing for final installation.

Optional Soldering of RibbonFlex Pro

Soldering is a fast and easy way to join wires and make splice connections. It is also the surest method for making extra reliable electrical connections.

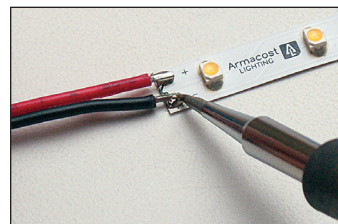

Wire Lead Connection

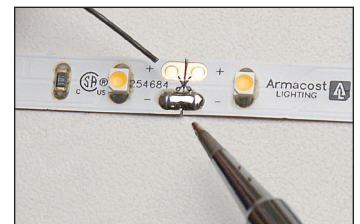

Splice Connection

To learn how to solder RibbonFlex Pro, visit armacostlighting.com/installation.

Note: Soldering connections is required for marine or RV applications due to vehicle movement and vibrations.

Power supply location and voltage drop

Voltage drop is the gradual decrease in voltage that occurs from your power supply to your LED lighting. The shorter the 12V DC wire leads between the power supply and the LED lighting, the brighter and more consistent the lighting will be – also do not coil extra wire. If the LEDs farthest from the power supply appear dimmer, it is probably due to voltage drop. Voltage drop only becomes undesirable if you notice the brightness in one area of your lighting is objectionably different than in another area. As a practical approach, test your LED lighting prior to final installation. If voltage drop appears to be an issue, use thicker, heavier gauge wires or use less lighting. To determine what wire will work best in your design, visit armacostlighting.com/voltagedrop for an easy-to-use online voltage drop calculator.

Configuration options and LED tape light power requirements

RibbonFlex Pro offers endless connection options to fit virtually any installation imaginable. LED tape strips can be installed in series (strips connected or wired end-to-end) or in parallel (multiple legs of LED strips or series of strips wired directly to a single power supply).

LED tape lighting power requirements are stated in watts, and are based on several factors, including design configuration (Straight Run, Center Feed/Loop Back or Array), voltage drop, and the length limitations of the LED tape lighting.

TYPICAL DESIGN CONFIGURATIONS	
<p>Straight Run</p> <p>Only one end of the LED strip is powered. Multiple strips can be connected in a series for a continuous run. LEDs farther away from the power supply may appear dimmer due to voltage drop, especially if longer wires are used in between to connect strips.</p>	
<p>Center Feed / Loop Back</p> <p>Either power two equal legs of tape lighting from the center or loop back and power both ends of the LED tape. These configurations will produce more consistent brightness and color over the length of the strip. A loop back is excellent for room perimeter tray ceiling or cove lighting.</p>	
<p>Array</p> <p>An array uses two or more legs of various lengths wired to a power supply in a parallel connection. You will need to calculate total wattage used in an array to guard against overloading the power supply.</p>	

Choosing a power supply

Each model of LED tape has a specific length limitation based on the number of LEDs per meter and voltage drop. Choosing a higher wattage power supply does not necessarily mean you can run longer lengths of LED lighting, however, it will allow for more lighting legs in overall design. Exceeding the lengths in the following chart will cause LEDs farthest from the power supply to appear dimmer when at 100% brightness. Using a higher wattage power supply will not reduce the effect of voltage drop.

Maximum recommended tape length – Model RF3528120, 120 LEDs/meter	
Straight run configuration	5 meters (16.4 ft) – will use approximately 36 watts
Center feed configuration	10 meters (32.8 ft) – will use approximately 72 watts
Array configuration	Varies based on layout and max wattage of power supply

Calculate the total wattage in your LED lighting system design

- Using the chart below, determine the watts used in each leg of lighting. A straight run is considered one leg. A center feed is two equal lengths of lighting. An array can have many legs. As a best practice use the next longer length on the chart below to determine approximate wattage per leg. Be sure to include only the lengths of LED tape in your calculation, not the connecting wires.
- Add together the watts used in each leg of lighting for total watts when lighting is at 100% full brightness. This will use the most energy.

Approximate watts used per meter at full brightness										
RibbonFlex Pro Model RF3528120 – 120 LEDs per meter										
Meters	0.5	1	1.5	2	2.5	3	3.5	4	4.5	5
Feet	1.6	3.3	4.9	6.6	8.2	9.8	11.5	13	14.8	16.4
Watts used	6	11	16	20	23	26	29	31	34	36

Watts used is the power consumed by your LED lighting system, not the watt rating of a power supply. Always choose a power supply rated greater than your needs. The watts shown are based on 100% full brightness.

Due to voltage drop, longer lengths of LED tape will use fewer watts per meter than shorter lengths. To accurately measure watts used by your LED lighting system, use a multimeter. Watts is calculated by multiplying volts by amps used in your LED system.

Switching, dimming and larger applications

If you do not have a switched 120V AC outlet for your LED power supply, consider an optional Armacost Lighting wireless wall switch or an Armacost 12-volt LED dimmer switch with optional RF wireless designer-style touchpad (works through walls up to 100 ft away).

You can also use a standard AC wall dimmer with your power supply if the power supply clearly states that it is AC dimmable with 120V dimmers. **Using a 120V AC dimmer with a standard power supply will not work and will damage the power supply.** For power supply options, visit armacostlighting.com/power-supply.

Larger lighting applications may require multiple zones of LED tape lighting – a single zone consists of tape lighting connected to one power supply.

For dimming large zones at one time, recommend using Armacost Lighting's AC dimmable power supplies with a Lutron-style in-wall dimmer. By dimming on the AC side, this solution allows for precision brightness control over all lighting zones with a standard dimmer.

You can also dim multiple lighting zones using one or more Armacost 12-volt wireless 2-in-1 LED dimmers, all paired to the same operating channel and controlled remotely by touchpad dimmers. To learn more, visit armacostlighting.com/dimming.

TYPICAL CONNECTING AND SWITCHING OPTIONS

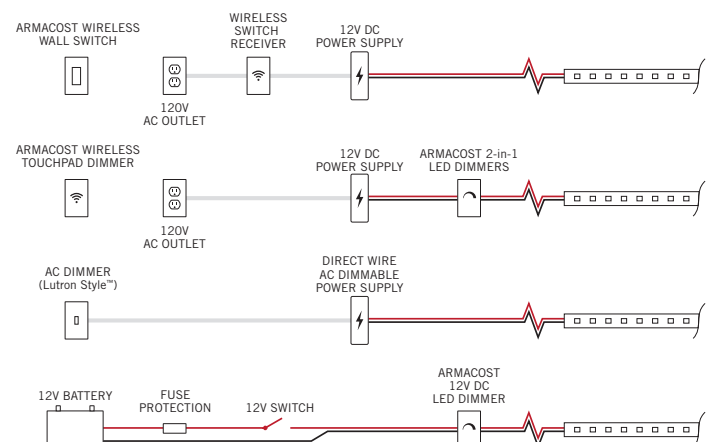

Interior RV and boat applications can be powered directly by 12V battery

Cutting, connecting and wiring

Warning: Do not connect LED tape to household 120V AC power. Only connect to low voltage 12V DC power.

Always maintain polarity when connecting LED tape lighting and low voltage power wires. Be sure to connect positive wires to positive (+ to +), and negative wires to negative (- to -). Polarity is easily identified with + and - markings on LED tape as shown.

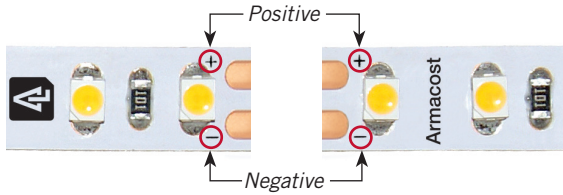

Cut with scissors

This tape light model can be cut every 3 LEDs, or about every 1".

- Whether you are soldering wires or using connectors, cut the LED tape with scissors **directly in the center of the copper pad** as shown in position "A" below.
- You can also cut the tape at position "B," however, do not use connectors on these soldered tape light joints. You can solder 12V power lead wires at these joints.

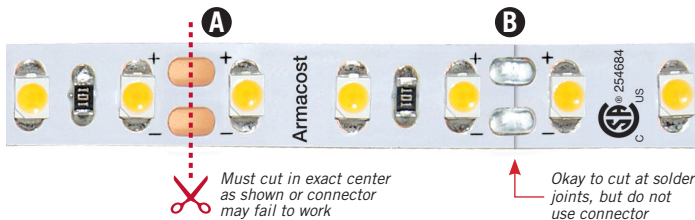

SureLock™ Connectors

SureLock Connectors supplied with wire are used for going around corners or, when cut in half, to create two power leads ("jumper" cables) for bridging gaps and extending wires.



IMPORTANT: Always use the + / - indicators printed on the tape light to maintain polarity.

To increase the length of wire between two LED strips, simply splice in the extra length of wire required, 18 AWG is generally recommended. Be sure to match polarity, + to +, - to -. Do not coil wire; shorter lengths and thicker wire will mean less voltage drop and higher brightness.



Be sure all 12V connections are secure and sealed. Options include soldering and heat-shrink tubing, crimp connectors, terminal blocks, wire nuts, etc.

SureLock™ Splice Connectors

SureLock Splice Connectors are for joining two strips to create a continuous run of LED lighting.

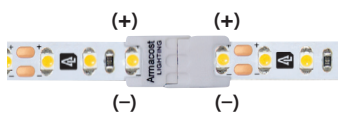

If the + / - marks do not line up, flip the tape and use the opposite end for proper alignment.

SureLock Direct-Connect™ System

Also available and sold separately are Wire-Ready SureLock Connectors. Part of the Direct-Connect™ System, this solderless connection solution reduces the need for splicing wires and allows you to easily make wire lead connectors that fit the exact size requirements of your lighting system. To learn more visit armacostlighting.com/connectors.

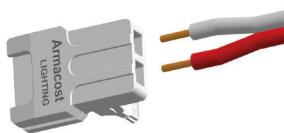

How to use SureLock Connectors

- Carefully peel back a small section of the 3M paper backing – remove only the paper, not the adhesive underneath.
- With the connector in an upright position ("Armcast" facing up), carefully insert the LED tape into the top channel grooves, as shown below.
- Be sure tape light is seated in the channel grooves. Using a slight side-to-side motion, push firmly so that tape slides fully into connector. This will ensure connector contacts make a secure connection with the LED tape.
- Turn the lighting on to test the connection prior to locking the pressure pad door.
- Once the lighting is working, securely lock the pressure pad door. If needed, put the tape and connector upside down on a hard surface and use a flat head screwdriver to close and lock the door in place.
- Perform an overall power test to ensure that all connections are secure and all LEDs light before final installation.

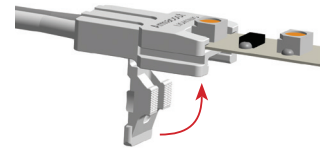
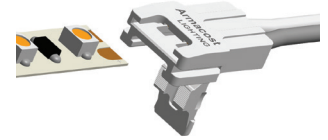

Once tape is fully inside connector, close the pressure pad door.

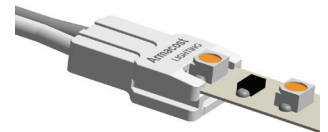

Ensure door is seated in both bottom side grooves before securely locking in place.

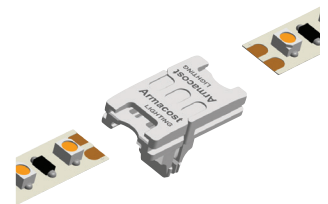

Follow the same instructions when using SureLock Splice Connectors.

It is possible to reuse a connector, but it should be reinstalled on a fresh cut section of tape. Removing and reinstalling the connector on the same copper pad section may make the connection less reliable.

For how-to videos on using SureLock connectors as well as soldering tips and techniques, go to armacostlighting.com/installation.

Surface preparation and installing peel-and-stick LED tape lighting

Before removing the 3M tan colored paper backing, it is important to test the LED strip in the space you intend to light. Once the paper backing is removed and the lighting is fully installed, you cannot reposition or move the LED tape light to another location. The tape may not stick securely.

- Power the LED tape lighting and temporarily hold or tape into position with painter's tape or masking tape – do not remove the 3M paper backing.
- Adjust the lighting to various angles and positions to get the desired level of illumination and lighting appearance. If the LEDs create undesirable bright spots on walls, or reflections, reposition the tape light strip farther away from surfaces or try a different mounting angle.
- Once you have determined your final mounting position, clean and prep the surface to ensure the 3M self-adhesive backing will adhere properly.

IMPORTANT

- Mounting surfaces should be smooth, clean, completely dry, dust free and above 60° F (15° C) before installing/sticking the LED tape lighting.
- Thoroughly clean all mounting surfaces with a 50:50 mixture of isopropyl alcohol and water. For extra dirty surfaces, first use 100% alcohol or acetone. Avoid the use of household cleaners and polishes that may leave behind residues. Also avoid common rubbing alcohol.
- For best adhesion lightly sand the surface where you will mount the tape lighting with fine grit sandpaper (150-300 grit). Sand in a circular motion rather than straight-line motion.
- When installing on painted surfaces, paint should be fully cured based on manufacturer's cure time.
- Be careful not to peel off the 3M adhesive from LED strip, just remove the tan paper backing.

- 3M sticky back tape requires pressure to activate the adhesive. Using a clean dry cloth over your fingers and working from one end to the other, firmly press the tape down the entire length of the strip.
- Support power wire leads, especially when mounting under cabinets and shelves.

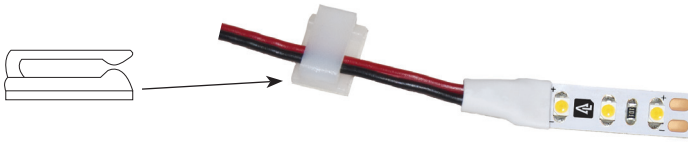

Although RibbonFlex Pro can be installed in curved and irregular spaces, avoid sharp bends or bending on the solder joints as you could damage the LED tape light. If an LED is inadvertently damaged and fails to light, the remaining LEDs will continue to operate. RibbonFlex Pro is made with 3 LEDs connected as one series. If you experience a failure, you can cut out and remove the damaged 3-LED series and splice together new and/or remaining LED tape.

Under Cabinet Mounting Tips

To surface mount LED tape lighting under a set of cabinets in one continuous run, drill a 1/2" hole through any cabinet side lip that may be present. Install LED tape lighting through the hole and surface mount as a continuous run.

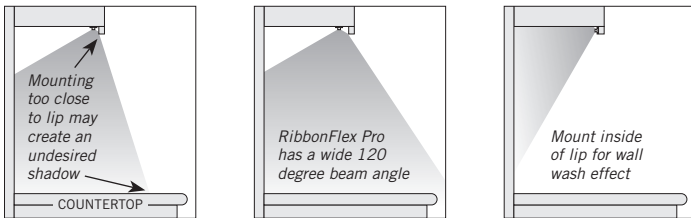

When mounting under a cabinet or a shelf with no lip to hide the LED tape light strip, create a visual barrier by using trim strip molding mounted in front of the LED tape light.



Above Cabinet Uplighting Tips

Most cabinet tops have uneven surfaces. To create beautiful indirect uplighting over cabinets, simply mount RibbonFlex Pro on any rigid strip (e.g., thin lattice or corner guard molding) and place on top of cabinets. Angle the strip position to achieve the desired illumination.

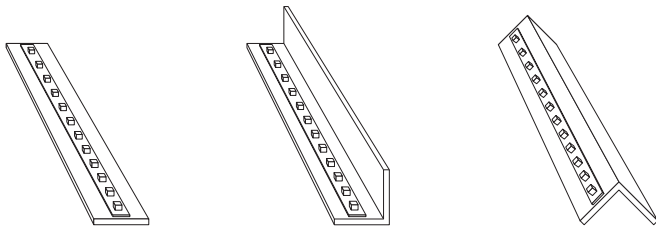

For a seamless glow and to avoid bright light spots, keep LED tape light strip at least 1/8" away from walls.

Cove Lighting Tips

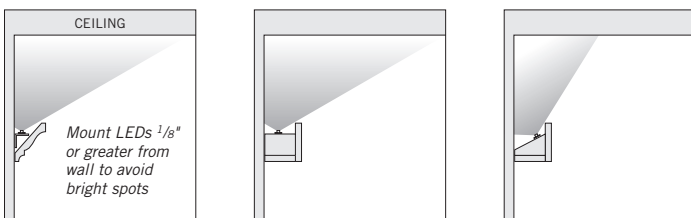

Troubleshooting

Tape light strip does not light

- Make sure your LED power supply is turned on and receiving power.
- Confirm you have maintained correct polarity (+ to + and - to -) when joining LED strips as well as when connecting to the 12V power supply.
- Check all tape light connections and any switch or dimmer connections from the power supply to the LED tape light. Consider testing with a multimeter to ensure light strip is receiving 12V power.

Only part of the LED tape light strip is lit

- Check connections to the part of the strip that is not lit.
- Confirm that you have maintained correct polarity to the unlit section.
- If only 1 LED series is out, cut out and remove the damaged 3-LED group and splice together LED tape strips or replace with new 3-LED section.

LED tape lights blink on, then go off

- Your power supply is not adequate for the length of LED tape light you are powering. Install a higher wattage power supply or reduce watts used by shortening the lengths of your LED tape lighting.

LEDs farthest from the power supply are noticeably dimmer

- This is the result of voltage drop. Decrease the length of the 12V power feed wires or use thicker power feed wires between the 12V power supply and the tape lighting.
- Use shorter lengths of LED tape lighting. Refer to **Configuration options** in these guidelines. Consider a different configuration.

Visit armacostlighting.com/installation for additional installation tips and FAQs.

Limited 3-year warranty

For terms and conditions, visit armacostlighting.com/warranty. Improper installation, abuse, or failure to use this product for its intended purpose will void warranty. This warranty only applies when all components, including LED power supplies, have been provided by or approved for use by Armacost Lighting. Substituting another manufacturer's product and/or components will void the warranty. The warranty does not cover labor or any other costs or expense to remove or install any defective, repaired or replaced products.

SPECIFICATIONS

Input Voltage.....	12V DC
LED Count	120 LEDs/m
LED Module	SMD 3528
Chip Size	10 x 23µ
Beam Angle	120° wide
Tape Height/Width	1.5 x 8mm
Cutttable.....	Every 1" approx (25mm)
Lumens Per LED	~7-8 lm
Color Accuracy (CRI).....	~80
Listings	CE, RoHS, CSA
Country of Origin	China



Designed in Baltimore, Maryland
Manufactured in China

armacostlighting.com

