

HOME
DECORATORS
COLLECTION

Item #1001320211
Model # HDC36DGV

USE AND CARE GUIDE

36in Vanity Ellia Collection

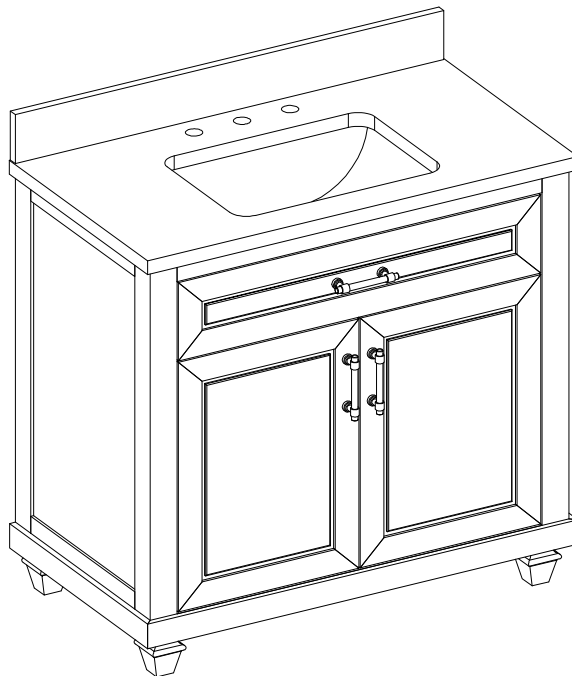

Questions, problems, missing parts? Before returning to the store,
call Home Decorators Collection Customer Service
8 a.m. - 6 p.m., EST, Monday-Friday

1-800-986-3460

HOMEDEPOT.COM/HOMEDECORATORS

THANK YOU

We appreciate the trust and confidence you have placed in Home Decorators Collection through the purchase of this fireplace console. We strive to continually create quality products designed to enhance your home. Visit us online to see our full line of products available for your home improvement needs. Thank you for choosing Home Decorators Collection!

Table of Contents

Table of Contents.....	2	Hardware Included	3
Safety Information.....	2	Package Contents	3
Warranty	2	Assembly.....	4
Pre-Assembly	2	Care and Maintenance	7
Planning Assembly	2		
Tools required	2		

Safety Information

Please read and understand these instructions before assembling and using this console. Save these instructions for future reference.

MAXIMUM RECOMMENDED WEIGHT LOADS



WARNING: Do not stand on vanity. Use vanity on level ground. Base vanity supports a maximum weight of 200 lbs. Exceeding maximum weight limit will compromise the integrity of the vanity structure and could cause the vanity to fail.

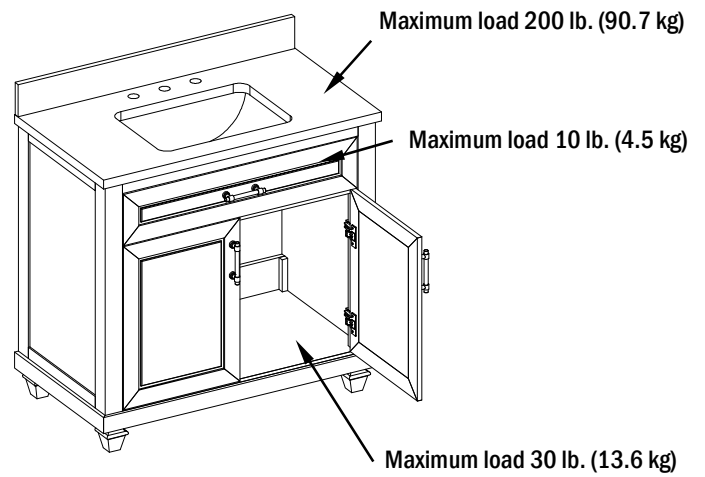

Warranty

We are confident that you will be delighted with this purchase. Should this product be defective in workmanship or materials, or fail under normal use, we will repair or replace it for a period of up to one (1) year from date of purchase.

This warranty gives you specific rights and you may also have other rights which vary from state to state.

Contact the Customer Service Team at 1-800-986-3460 or visit www.HomeDepot.com/homedecorators.

Pre-Assembly

PLANNING ASSEMBLY

Compare all parts with the Hardware Included and Package Contents list. If any part appears missing or damaged, do not assemble this product and contact the Customer Service Team at 1-800-986-3460.

TOOLS REQUIRED

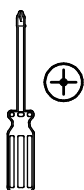

Phillips
screwdriver
(not provided)



Silicone
Compound
(not provided)

Pre-Assembly (continued)

HARDWARE INCLUDED



NOTE: Hardware not shown to actual size.

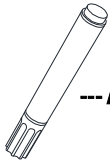

---AA

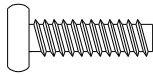

---BB



---CC



---DD



---EE

Part	Description	Quantity
AA	Touch up pen	1
BB	Bolt	8 + 1 extra
CC	Lock Washer	8 + 1 extra
DD	Flat Washer	8 + 1 extra
EE	Hex Wrench	1

PACKAGE CONTENTS

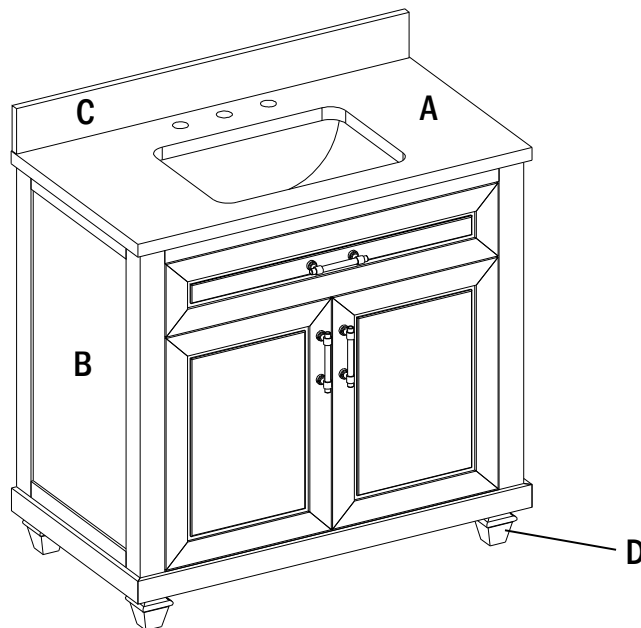

Part	Description	Quantity
A	Vanity Top (preassembled)	1
B	Vanity	1
C	Backsplash	1
D	Vanity Feet	4

Assembly

1 Vanity Feet Installation

- Attach vanity feet (D) to the vanity base (B) by inserting the bolt (BB) through lock washers (CC) and flat washers (DD). Tighten with hex wrench (EE).

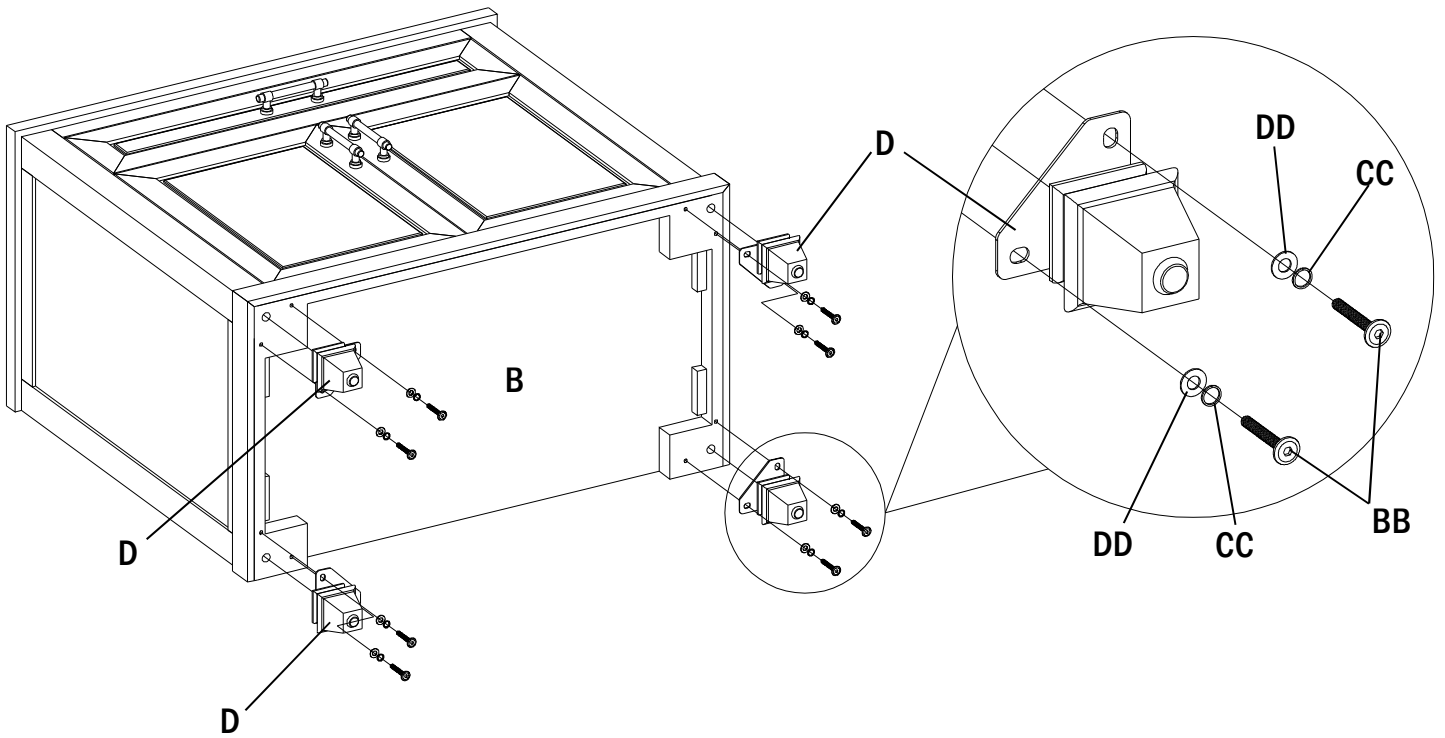

Assembly (continued)

2 Water Supply Lines and Drain Installation Guide

- Mark wall for vanity placement and note the location of the water supply lines and drain on the back panel of vanity.
- Move vanity (B) into proper place against the wall.
- Install faucet, drain and supply lines (none included) to vanity top (A) according to the instructions supplied with those items.

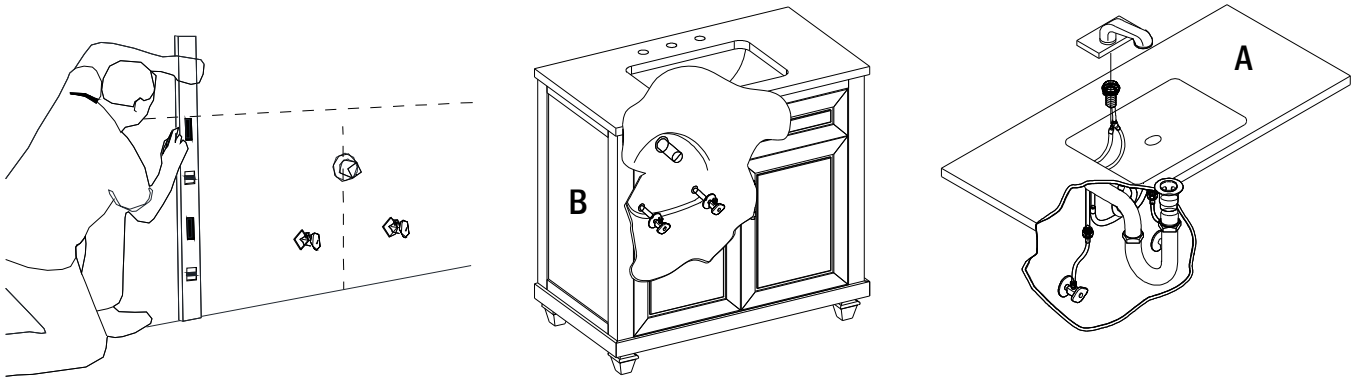

3 Adjustable Level

- In case of uneven floors, floor levelers are provided at the bottom of the vanity. If necessary, adjust floor levelers by hand to correct tilting and/or level doors.

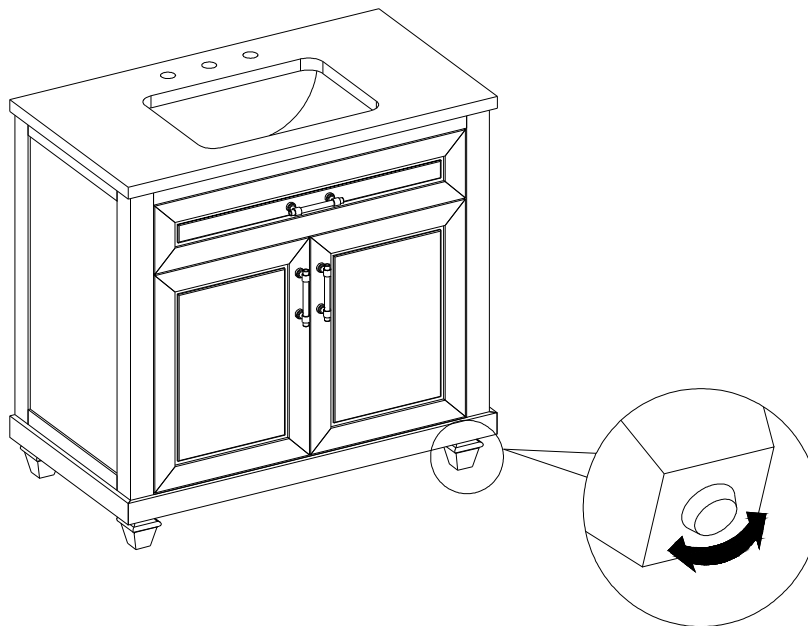

Assembly (continued)

4 Backsplash Installation

- To mount the backsplash (C) to the wall, apply a thin bead of silicone compound (not included) to the unpolished back side and bottom of the backsplash (C). Position backsplash (C) as shown onto vanity top (A) and against the wall. Clean any excess silicone compound before allowing to dry.

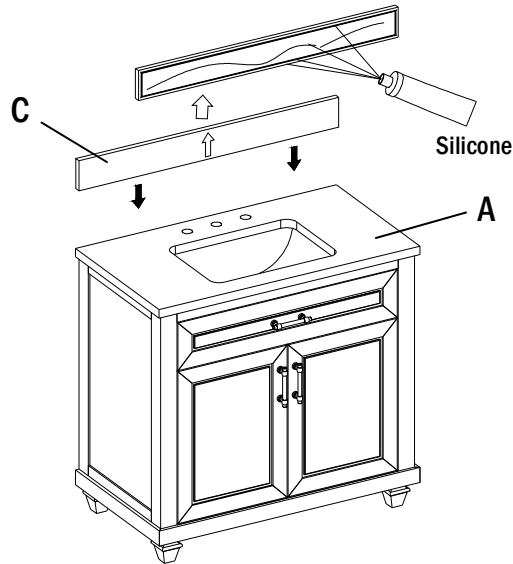

5 Hinge Adjustment For Door Alignment

- If the doors preassembled to vanity base (B) require adjustment, follow the below options as needed:
- To adjust door up or down, loosen screws (a), adjust door and retighten screws.
- To adjust door left and right, turn screw (b) in or out.
- To adjust door in and out, loosen screw (c), adjust door and retighten screw.

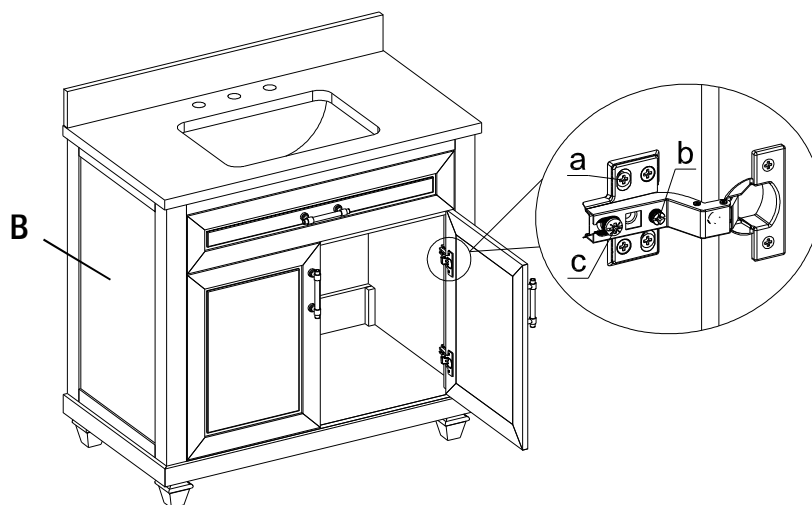

Care and Maintenance

- Dust the vanity regularly with a soft, non-lint producing cloth or household dusting product.
- You can clean the vanity with a gentle, non-abrasive household cleaner. Make sure to dry the wood immediately with a soft cloth or towel.
- The granite top can be cleaned using standard granite cleaning agents (sold separately).
- Tips for using touch-up pen (AA): For scratches, stroke in direction of scratch; for worn areas, stroke in direction of wood grain. Rub excess colorant promptly with a soft cloth.
- Keep product away from direct sunlight as it may damage the finish.
- Please clean all fluids from the stone surface to prevent stains. we strongly suggest that red wine spills be wiped off immediately to prevent permanent damage to the stone surface.

CARING FOR WOOD FURNITURE

It is best to keep your furniture in a climate-controlled environment. Extreme temperature and humidity changes can cause fading, warping, shrinking and splitting of wood. It is advised to keep furniture away from direct sunlight as sun may damage the finish.

Proper care and cleaning at home will extend the life of your purchase. Following these important and helpful tips will enhance your furniture as it ages.

HOME DECORATORS COLLECTION

Questions, problems, missing parts? Before returning to the store,
call Home Decorators Collection Customer Service
8 a.m. - 6 p.m., EST, Monday-Friday

1-800-986-3460

HOMEDEPOT.COM/HOMEDECORATORS

Retain this manual for future use.