

GENERAL SAFETY INFORMATION:

- To reduce the risk of death, personal injury or property damage from fire, electric shock, falling parts, cuts/abrasions, and other hazards read all warnings and instructions included with and on the fixture box and all fixture labels.
- Before installing, servicing, or performing routine maintenance upon this equipment, follow these general precautions.
- DO NOT INSTALL DAMAGED PRODUCT!

CAUTION:

- Turn off the switch and circuit breaker before installing this LED lamp.
- Suitable for dry locations.
- Not for use with dimmers.
- Use only insulated staples or plastic ties to secure the cord.
- Not intended for recessed installation or on ceiling.
- Do not install directly over a heat source (stove, etc.)
- Use safety precautions. Safety eye glasses and gloves are recommended.
- Installation should not be made on a radiant-heating ceiling.
- Injury to people and damage to the lamp and/or mounting surface may result if the lamp is pulled from the surface. To reduce the likelihood of such injury or damage, mount only on a mechanically sound surface.
- Do not alter the plug or power supply cord in any way or try to install this product in any other method besides method shown on this sheet.

NOTICE:

- This device complies with Part 15 of the FCC Rules. Operation is subject to the following two conditions: (1) This device may not cause harmful interference, and (2) this device must accept any interference received, including interference that may cause undesired operation.
- To install onto a plaster board surface, plaster board requires minimum 3/8" thick.

PRODUCT SPECIFICATION:

Part Number: MSL-202000F, MSL-202500C
Input Voltage: 120 VAC
Amp Draw: 0.18 A
Frequency: 60 Hz
Rated Power: 20W
Suitable for: Dry Locations
Linkable: 4 Units Maximum

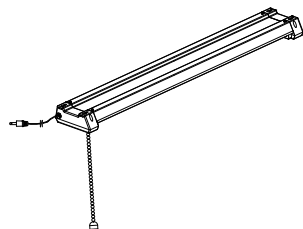

PARTS LIST:

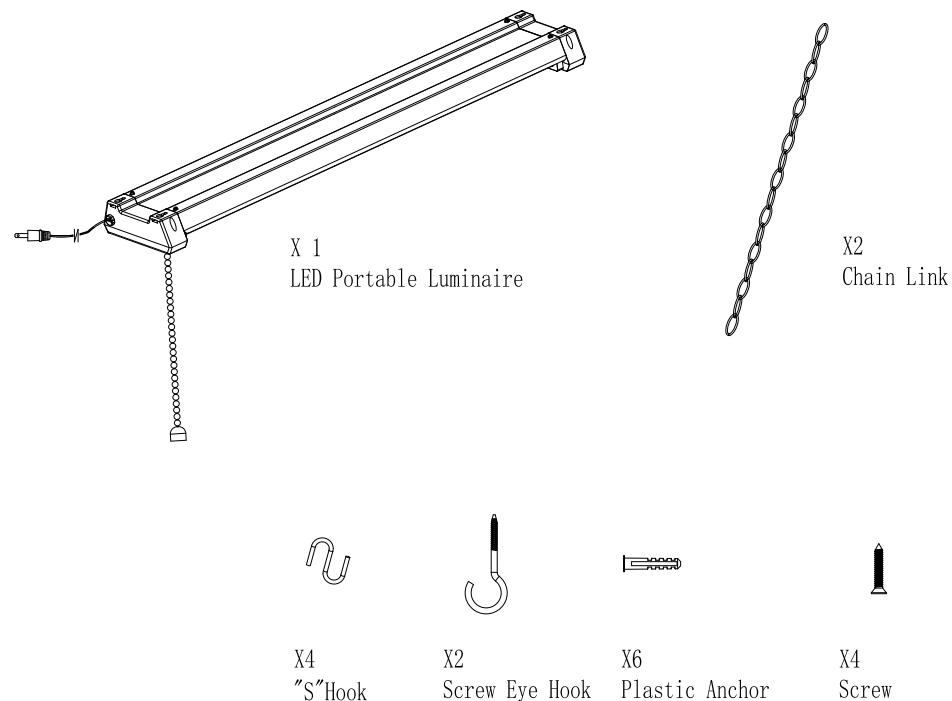

THREE YEAR WARRANTY:

Maxxima extends a 3 year limited warranty to the original purchase that the products listed are free from defects in material and/or workmanship only. Maxxima will replace any warrantied product to the original consumer/purchaser if the product fails because of defects due to workmanship and/or materials within the limited warranty period. Limited warranty is not transferable and applies to the original installation of the Maxxima product. This offer does not constitute in any way a product guarantee and Maxxima does not hereby assume any obligation whatsoever beyond sending a free replacement product.

CONTACT US:

- ✉ info@maxximastyle.com
- 🌐 www.maxximastyle.com
- ☎ 866-MAXXIMA (629-9462)
- 📍 125 Cabot Court, Hauppauge, NY 11788

CHAIN INSTALLATION (RECOMMENDED):

1. Mounting surface must be capable of supporting the fixture. For plaster board ceiling, #8 screw eye hooks with plastic anchors are included or expansion bolts may be used (not included). If installed onto a plaster board surface, we recommend minimum 3/8" thick.

NOTE: You are responsible for secure installation.

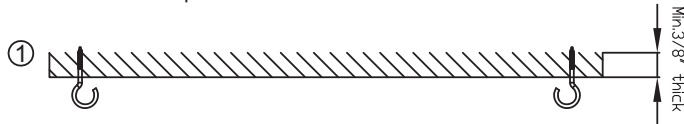

2. Install the 2 plastic anchors 22.83" apart, then screw the eye hook into each anchor.

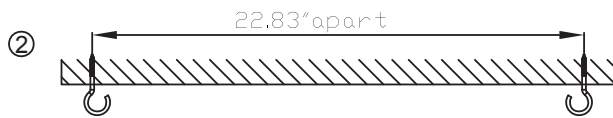

3. Install one "S" hook into each end of the chain, then crimp the "S" hook end which is attached to the chain with pliers. (Leave one side open from the "S" hook) Repeat step for the second chain provided.

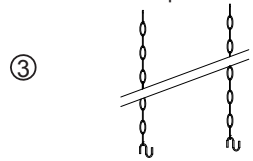

4. Install the "S" hook from one end of the chain into the end cap of the LED lamp, then crimp the hooks end with pliers. Repeat same step for the opposite side.

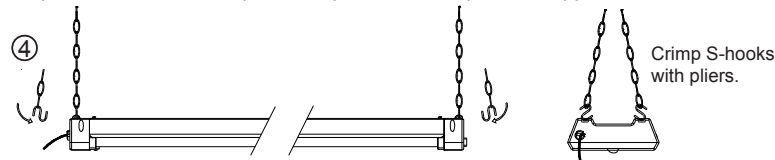

5. Install the LED lamp with chains, one end at a time on to each screw eye hook. Crimp screw eye hook if needed.

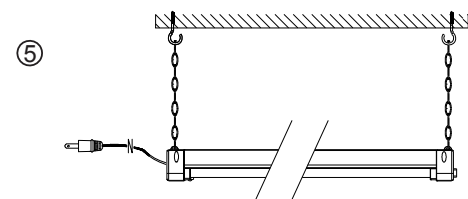

6. Plug the power supply cord into the electrical outlet.

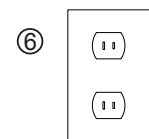

FLUSH MOUNT INSTALLATION:

1. Mounting surface must be capable of supporting the fixture. For plaster board ceiling, #8 screws with plastic anchors are included. If installed onto a plaster board surface, we recommend minimum 3/8" thick.

NOTE: You are responsible for secure installation.

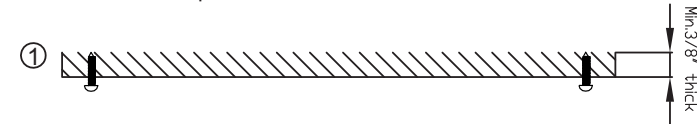

2. Install the 4 plastic anchors 22.64" apart across the long side and 3.19" apart across the short side as seen in the figures below. Insert the screw into each anchor and tighten it. The space between the ceiling and the head of the screw should be at least 0.33".

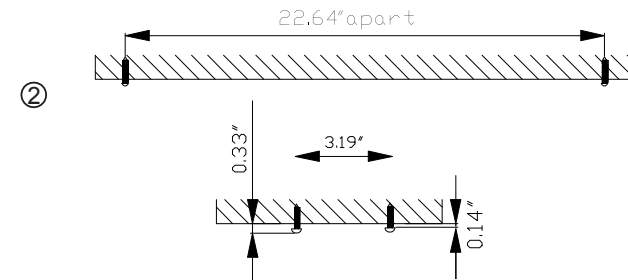

3. Lift the fixture and line up the four mounting slots on the bottom to the screws. Slide it towards the side with the power cord to secure it into place (In the case shown in Figure 3, slide to the right since the power cord is on the right side).

NOTE: Secure the power cord firmly away from the fixture such that the fixture is securely held in place and anchored to the screws. Please use discretion to properly place the power cord away from traffic so that the fixture may not slide out of place and fall due to accidental contact.

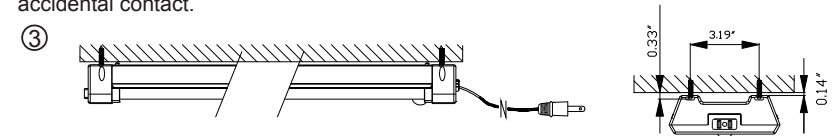

4. Plug the power supply cord into the electrical outlet.

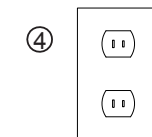

LINKING MULTIPLE SHOPLIGHTS:

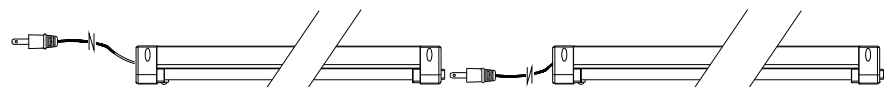

Connect to electrical outlet.

Link shop lights together if needed. Secure loose cord slack.

CAUTION: Link a maximum of 4 shop lights together. Do not use shop light outlets to power anything other than these style shop lights.