

USER CARE & INSTALLATION GUIDE

Package Contents:

- 3 Extendable Double Rod Brackets
- 6 Philips Pan Head Screw
- 6 Wall Anchors

Tools needed:

Tape Measure, Pencil, Drill & Bit Set, Philips head Screwdriver, Level

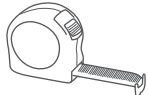

Tape Measure



Pencil



Drill & Bit Set



Philipshead
Screwdriver



Level

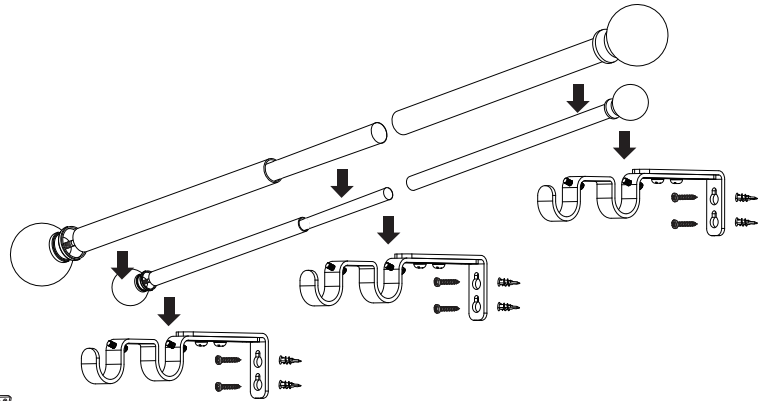

BRACKET INSTALLATION

STEP 1.

Place brackets against wall at desired locations and mark screw holes. Use tape measure and level to make sure marked screw holes are horizontal to each other.

STEP 2A. (FOR MOUNTING TO DRYWALL OR PANELING)

Pre-drill two pilot holes for each bracket (1/4" drill bit) and insert anchors into wall and insert screws into wall anchors.

STEP 2B. (FOR MOUNTING TO WOOD OR STUDS)

If mounting directly into wood or studs, pre-drill two pilot holes for each bracket (1/4" drill bit) and install bracket on the wall with screws provided.

STEP 3.

Determine projection of brackets. Loosen projection screw, slide bracket to desired position and tighten projection screw. Repeat for each bracket.

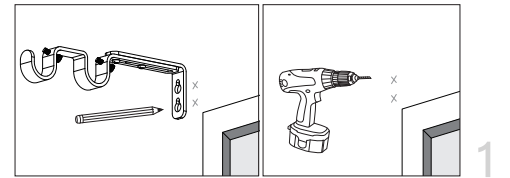

1

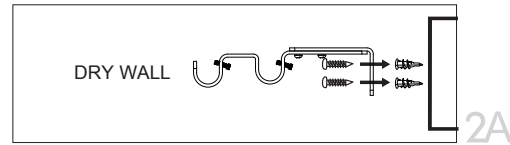

2A

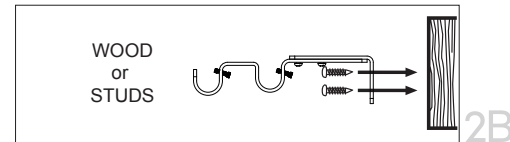

2B

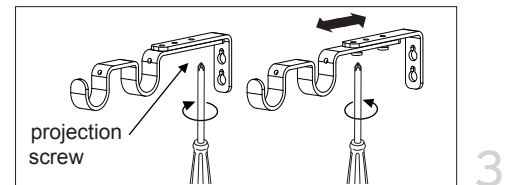

3

ROD INSTALLATION

STEP 4.

Place sheer panels on sheer rod and curtain panels on curtain rod. Note that panels, rods, and finials are sold separately.

STEP 5.

Slide rods onto the brackets and add finials to the ends of the rod.

STEP 6.

Secure each rod by tightening screws provided.

Care Instruction:

Wipe gently with cloth to clean any sand, dirt, or dust on product. Do not use abrasive cleaners as they may damage the surface finish.

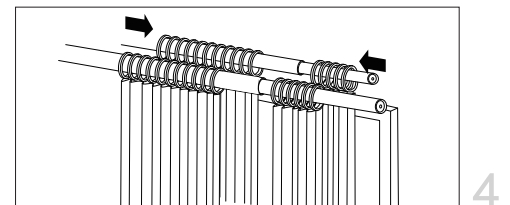

4

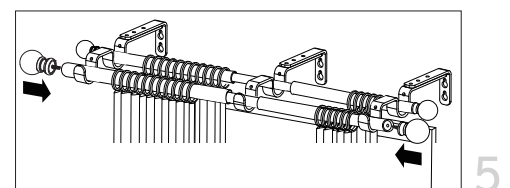

5

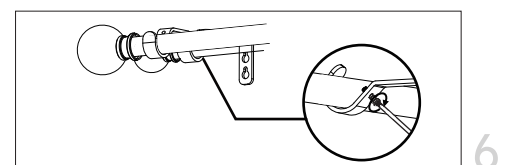

6