



ENGLISH

convert

Smart Lock Conversion Kit

Installation and User Guide

Online interactive instructions

View interactive, animated instructions online at

<http://kwik.st/convert-zw>

or continue to use the paper instructions.



Tools needed

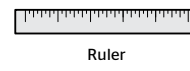
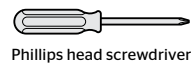

Kit "A"	Kit "B"	Kit "C"
<p>Black mounting plate</p> <p>Black adapter</p>	<p>Gold mounting plate</p> <p>Gold adapter</p> <p>Black adapter</p>	<p>Silver mounting plate</p> <p>Silver adapter</p> <p>Gold adapter</p>
<p>Mounting plate screws</p> <p>Interior assembly screws</p> <p>Interior cover screws</p>	<p>Mounting plate screws</p> <p>Interior assembly screws</p> <p>Interior cover screws</p>	<p>Mounting plate screws</p> <p>Interior assembly screws</p> <p>Interior cover screws</p>
<p>Interior cover</p>	<p>Interior assembly</p>	<p>Battery pack and 4 AA batteries</p>

1 Prepare your door

A Make sure your existing deadbolt is compatible. If you have a standard deadbolt mounted separately from the handle below it, it is compatible with Kwikset Convert.

Compatible

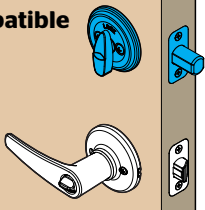

Not Compatible

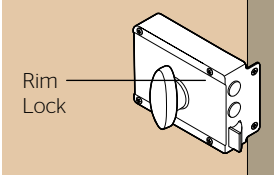

Not Compatible

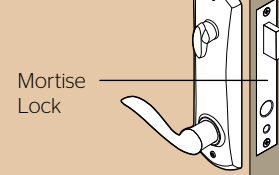

Not Compatible

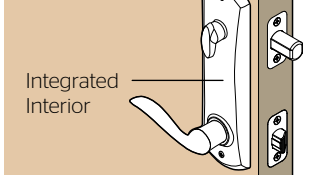

B Make sure your door is aligned before proceeding with installation.

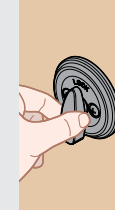

You should be able to lock and unlock your door smoothly without any resistance, and without pushing, pulling or lifting your door.
If your door is not aligned, you may need to order a Warped Door Service Kit, available through Kwikset Support: 1-866-863-6584

C Measure to confirm that your door is either 1-3/8" or 1-3/4" (35 mm or 44 mm) thick.

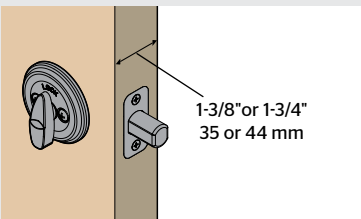

D Make sure your door is open and extend your latch bolt. Make sure your key is NOT in the deadbolt exterior.

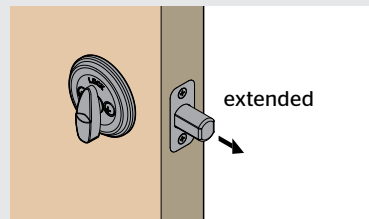

E Optional: Secure your deadbolt exterior with masking tape.

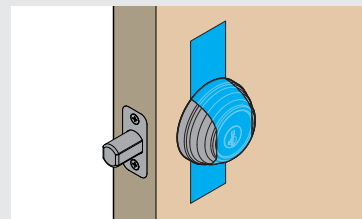

F Remove all existing deadbolt hardware from the interior side of your door.

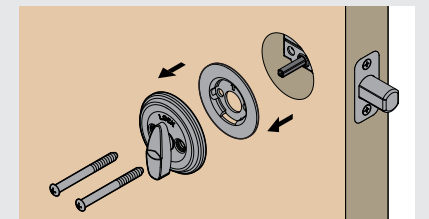

2 Determine the parts needed for your door

Look into the hole in your door. What shape is your torque blade (the part sticking out through the latch)?

D-shape

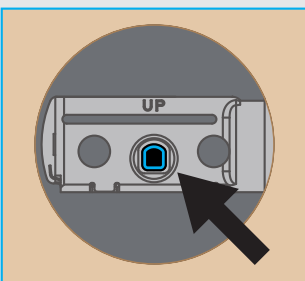

Kwikset and Weiser deadbolts:
Use kit "A" for your door.

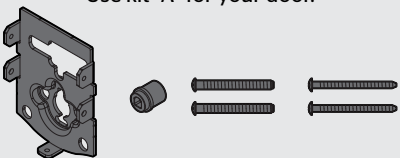

Baldwin Reserve and Baldwin Prestige deadbolts:
Use kit "B" for your door.

You will need the black adapter and the thicker gold screws.

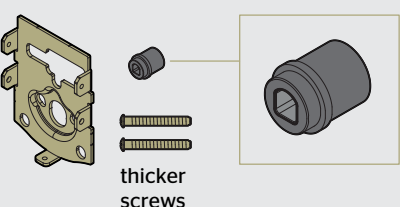

Vertical rectangle

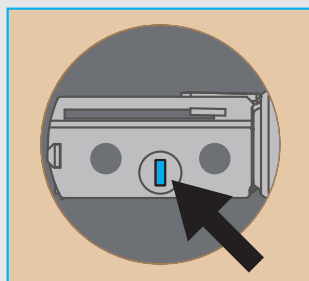

Baldwin Estate deadbolts:
Use kit "B" for your door.

You will need the gold adapter and the thinner gold screws.

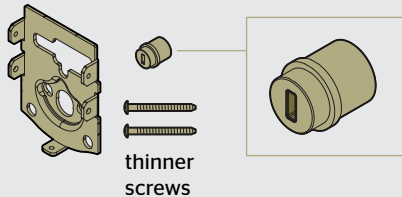

Slanted rectangle

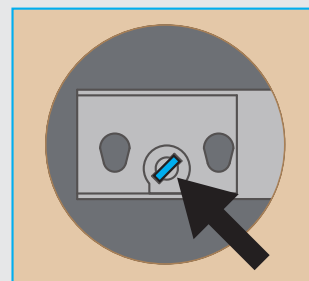

Schlage deadbolts:
Use kit "C" for your door.

You will need the silver adapter.

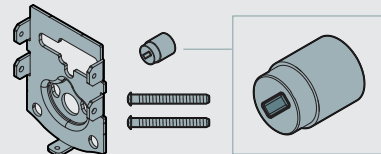

Horizontal rectangle

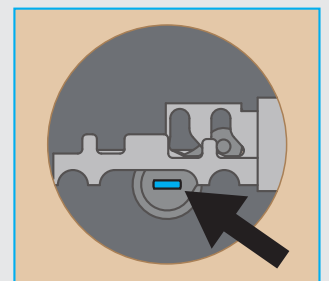

Schlage deadbolts:
Use kit "C" for your door.

You will need the gold adapter.

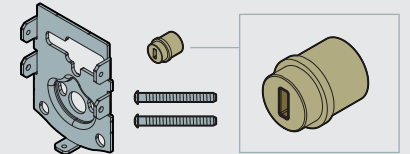

For a list of compatible deadbolt models, please see the Kwikset Convert page at www.kwikset.com

3 Install the mounting plate and test your latch

A Place the mounting plate on the door so that the torque blade inserts through the center hole.

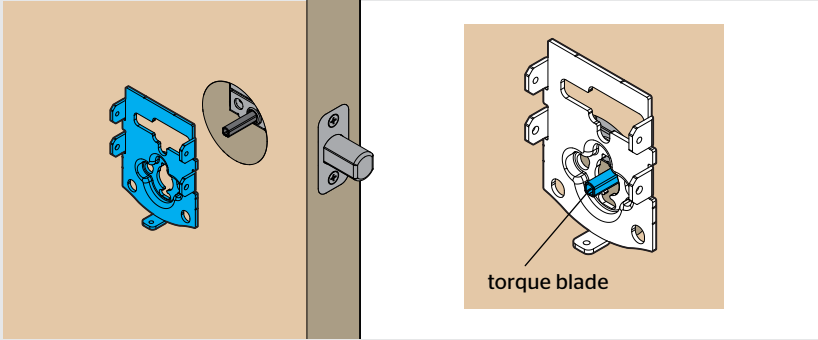

Note: A D-shaped torque blade is shown, but installation is the same for all models.

B Secure the mounting plate with the mounting screws.

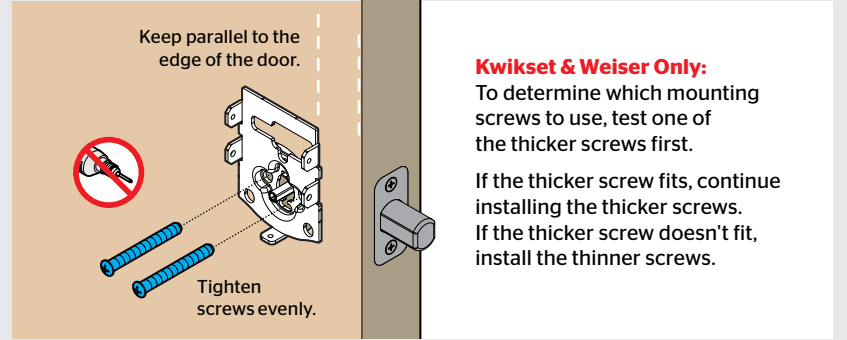

C Remove the masking tape from the exterior deadbolt, and insert your key and test the latch for smooth operation.

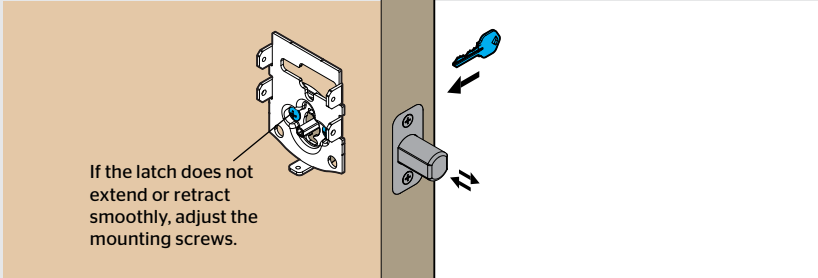

D Remove your key and make sure the bolt is fully extended.

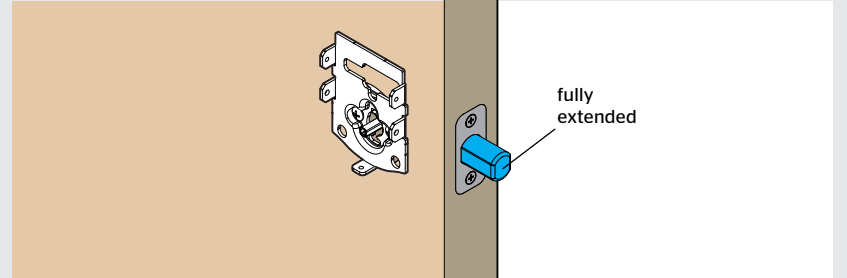

4 Install the interior assembly

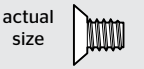

A Remove the interior cover and battery pack.

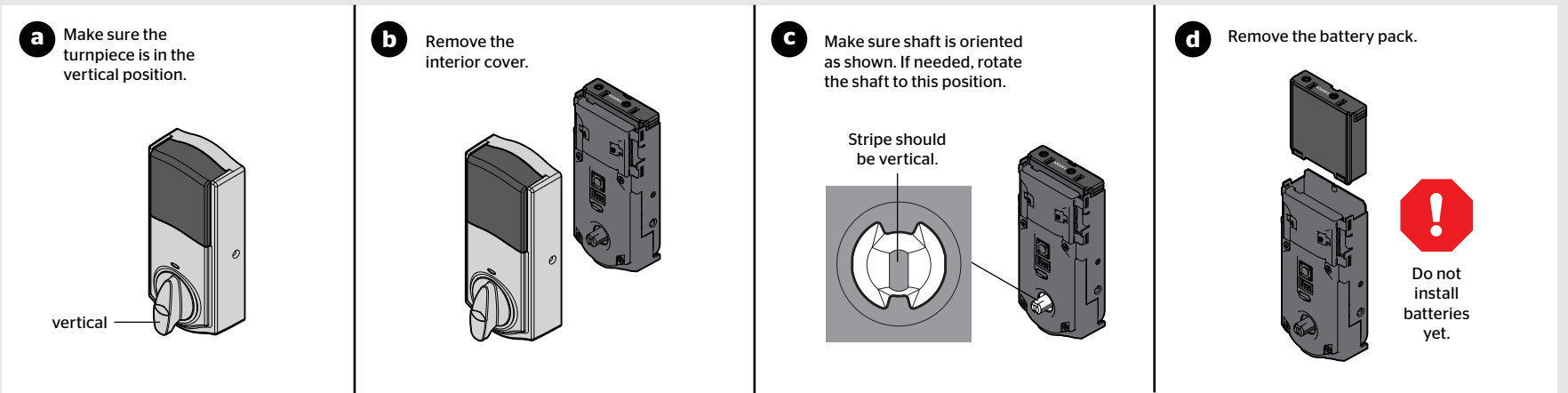

B Install the adapter on the interior assembly.

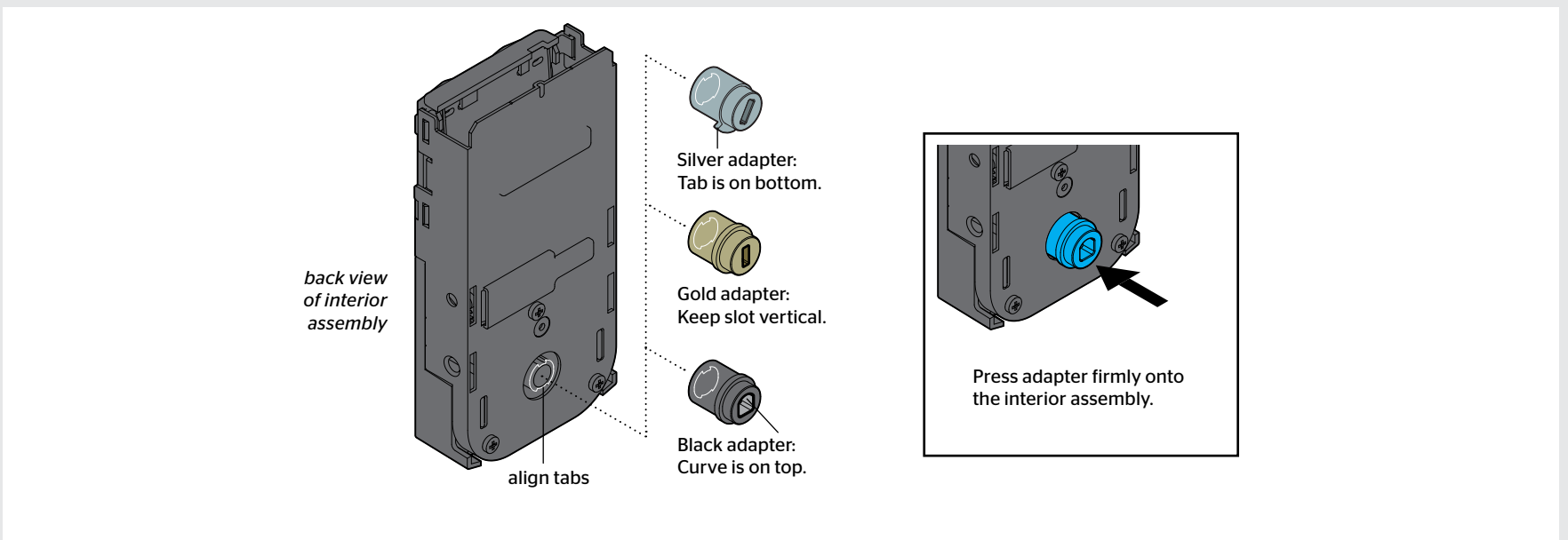

C Align the adapter with the torque blade and push the interior assembly onto the mounting plate.

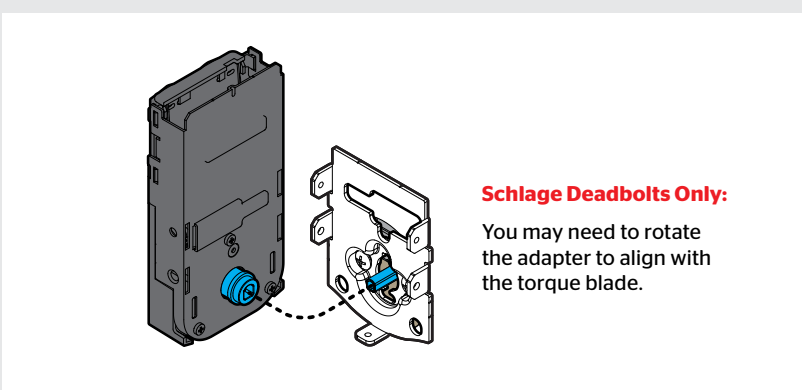

D Secure with two (2) interior assembly screws.

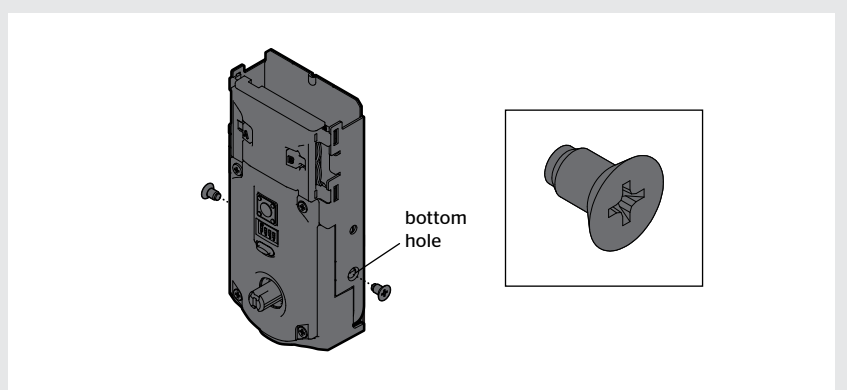

5 Perform the door handing process

This step will teach the lock the orientation of your door and is crucial for lock operation.

- A** Install 4 AA batteries in the battery pack.

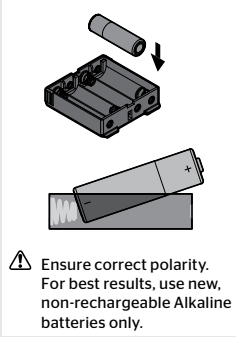

- B** Make sure the door is open. Insert the battery pack while **PRESSING AND HOLDING** the Program button. Keep pressing the button for three seconds after the battery pack is installed, then release the button.

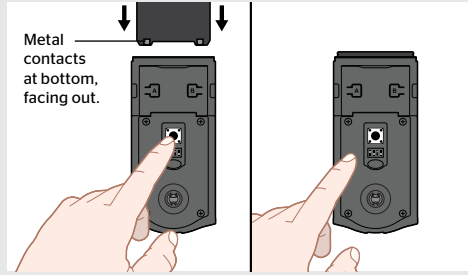

- C** The Status LED will flash red and green, and the lock will beep. **Press and release the Program button again.**

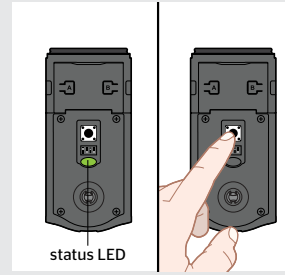

- D** The latch bolt will retract and extend on its own to learn the orientation of the door. Did the Status LED turn green or red?

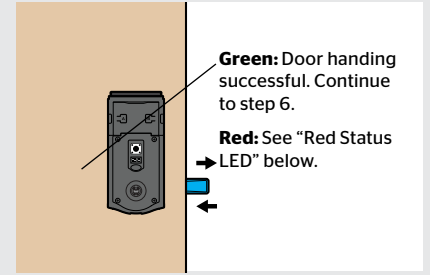

If the bolt does not move, make sure the batteries are installed correctly, and perform steps 5A-5D again.

Red Status LED

BALDWIN ESTATE DEADBOLTS:

If your latch bolt is to the **RIGHT** of your interior assembly, and the Status LED is solid red after door handing, **press and release the Program button again**. The door handing process will restart.

If you are unsure if your lock is Baldwin Estate, see chart on page 1 or compatible deadbolt list online.

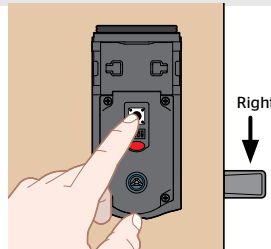

OTHER DEADBOLTS:

If the Status LED is solid red after door handing, make sure the batteries are installed correctly and the lock interior is correctly installed. Perform steps 5A-5D again.

6 Check the Status LED

- A** The Status LED blinks every six seconds to communicate whether the door is locked or unlocked.

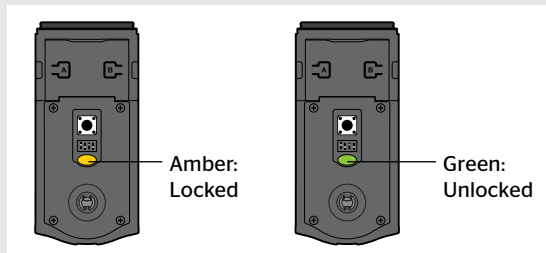

- B** Use your key to lock and unlock your door, and verify that the Status LED is communicating correctly.

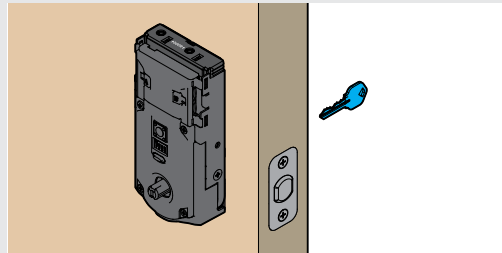

- C** If the Status LED is displaying the wrong door lock status, flip switch #4 to the ON position.

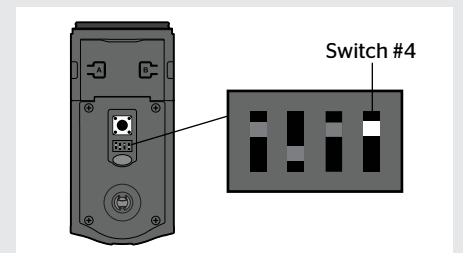

7 Add the lock to your smart home system

- A** Initiate the process to add the lock to your system at your smart home controller. Refer to your smart home system instructions for more information.

- B** When prompted by your smart home system to add the lock, press button "A" on the lock interior one time. The red LED will illuminate when the lock enters Add Mode.



Please allow time for the controller to add the lock.

- C** If successful, re-name the lock in your system (if applicable).

- D** If unsuccessful, follow your system's instructions to remove the lock from the controller and any other network, then press button "A" on the lock one time. Perform steps 7A-7C again.

If still unsuccessful, see "Troubleshooting: Adding the Lock to a Smart Home System" on page 4.

8 Install the interior cover

actual size

Important Information about the interior cover

The window on the interior cover is locked by default to prevent someone from tampering with your lock's settings.

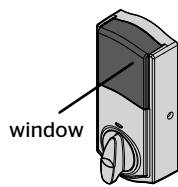

If you wish to unlock the window, you can slide it up for more convenient access to the programming buttons while the cover is installed.

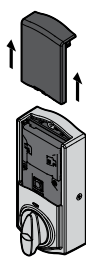

To unlock the window, remove the security screw.

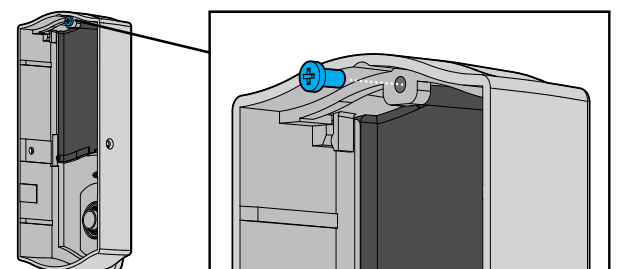

Cover Installation:

- a** Install cover.

Note: You may need to rotate the turnpiece to align with the turnpiece shaft.

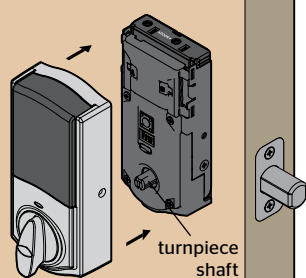

- b** Install screws.

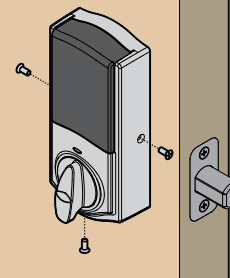

Note: The interior cover and screws must be removed for battery pack access.

Kwikset Convert at a Glance

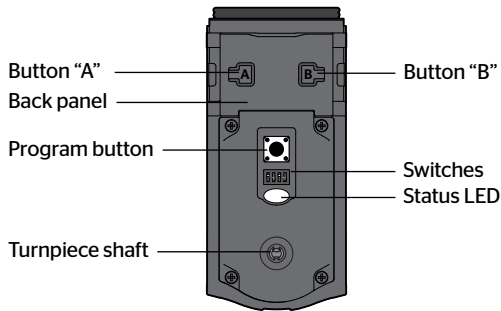

Switches

These features can be adjusted in some smart home apps.

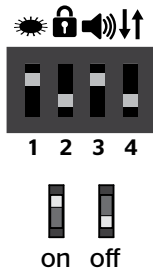

- 1. Status LED**
Door lock status LED blinks every 6 seconds. ON position is factory default.
- 2. Auto-Lock** ⚠️
Automatically re-locks door 30 seconds after unlocking. OFF position is factory default.

CAUTION: With this feature enabled, it is possible to lock yourself outside.

- 3. Audio**
Beeping sound is heard during programming and normal operation. ON position is factory default.
- 4. Invert** ⚠️
Only used if the Status LED is communicating the opposite door lock status.

Status LED Notifications

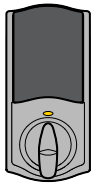

Amber flash
Door is locked.

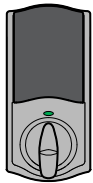

Green flash
Door is unlocked.

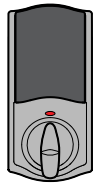

Red flash
The 4 AA batteries in the interior are low and need to be replaced.

Factory Reset

A factory reset will remove your lock from your smart home system.

<p>1 Remove battery pack.</p>	<p>2 Press and HOLD the Program button while reinserting the battery pack.</p> <p>Keep holding the button for 30 seconds until the lock beeps and the status LED flashes red.</p>
<p>3 Press the Program button once more. When the LED flashes green and you hear one beep, the lock has been reset.</p>	<p>4 Perform the door handing process again to teach the lock the orientation of the door and pair the lock to your smarhome system.</p>

Troubleshooting: Adding the Lock to a Smart Home System

Some Z-Wave® systems require that the lock be within 12" of the controller during the adding process. If this is the case, follow the steps below to remove the lock interior from the door to perform the process closer to the controller:

1. Remove the small screws that secure the interior assembly to the mounting plate.
2. Remove the interior assembly from the door.
3. Hold the interior assembly a maximum of 12" (305 mm) from your smart home controller for the rest of this process.

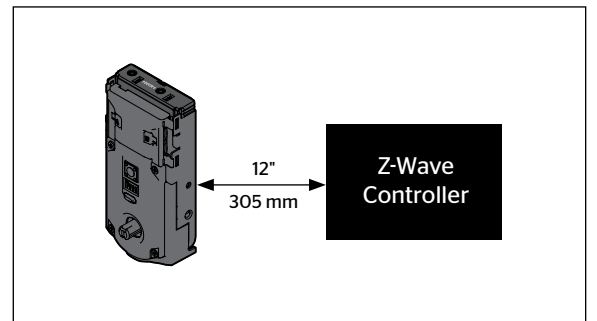
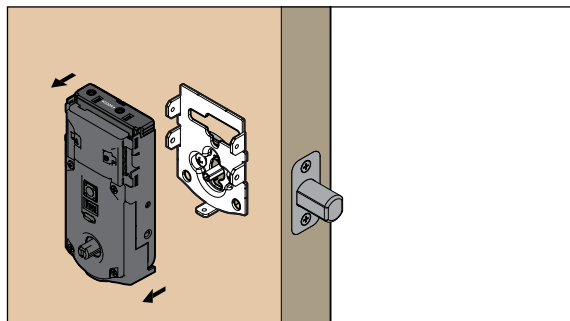
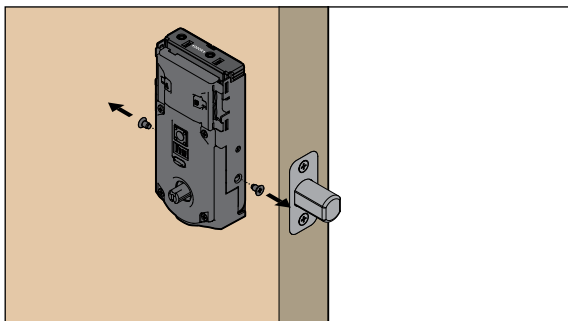

4. Initiate the process to add the lock to your system at your smart home controller. Refer to your smart home system instructions for more information.
5. When prompted by your smart home system to add the lock, press button "A" on the lock interior one time. The red LED will illuminate when the lock enters Add Mode.
6. Once successful, re-name the lock in your system (if applicable). Then, reinstall the lock interior on the interior assembly.

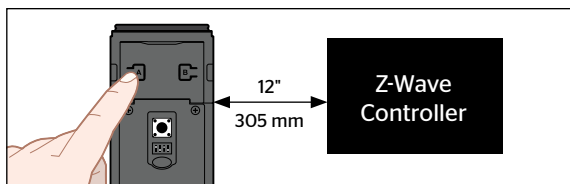

Please allow time for the controller to add the lock.

Network Information

Removing the lock from the network

Follow your smart home system's instructions to remove the lock from the network. When prompted by the system, press button A" on the lock interior once.

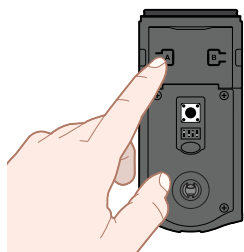

Z-Wave System Notes

This product is a security enabled Z-Wave Plus product and must be used with a Security Enabled Z-Wave controller to be fully utilized. Z-Wave is a "Wireless mesh network," and results may vary based on building construction and communication path.

To assure interoperability, each Z-Wave product must pass a stringent conformance test to assure that it meets the Z-Wave standard for complete compliance with all other devices and controls. The Z-Wave identity mark assures consumers, integrators, dealers and manufacturers that their products will reliably perform with any other Z-Wave device. And, regardless of the vendor, always powered nodes may act as a repeater for Kwikset/Weiser/Baldwin products.

Z-Wave Configuration and Association Parameters are available on the Kwikset Convert page at www.kwikset.com.

Important Safeguards

1. Read all instructions in their entirety.
2. Familiarize yourself with all warning and caution statements.
3. Remind all family members of safety precautions.
4. Always have access to your lock's standard key.
5. If using the Auto-Lock feature, make sure to have your standard key with you to prevent locking yourself out.
6. Replace low batteries immediately.

CAUTION: Prevent unauthorized entry. Restrict access to your lock's back panel and routinely check your settings to ensure they have not been altered without your knowledge.

WARNING: This Manufacturer advises that no lock can provide complete security by itself. This lock may be defeated by forcible or technical means, or evaded by entry elsewhere on the property. No lock can substitute for caution, awareness of your environment, and common sense. Builder's hardware is available in multiple performance grades to suit the application. In order to enhance security and reduce risk, you should consult a qualified locksmith or other security professional.