

HOME-FLEX[®]

UNDERGROUND

System Design and Installation Manual



**Know what's below.
Call 811 before you dig.**

*Flip
over for
HOME-FLEX CSST*

Suggested Tools for Installation of HOME-FLEX Underground®



Ratcheting Pipe Cutter

Use to cut HOME-FLEX Underground® MDPE pipe to desired length.



2x Large Groove Joint or
PVC Fitting Pliers

Use to tighten the fitting nut against the fitting flange.



Gloves



Eye Protection

For technical support call: **661-257-3923** or email: **info@homeflex.com**

HOME-FLEX Underground®

System Design and Installation Manual

Chapter 1: Introduction

1.1 Introduction.....	1
1.2 User Warnings.....	2
1.3 Limitations of Manual.....	3
1.4 Applicable Codes and Standards	3
1.5 Prohibited Installation Practices	3

Chapter 2: Description of System Components

2.1 Gas Pipe	4
2.2 Fittings	5
2.3 Transition Fittings	8
2.4 Anodeless Service Riser.....	8

Chapter 3: System Configuration and Sizing

3.1 Configuration	10
3.2 Reference Data for Proper Sizing	11
3.3 Sizing Methods and Examples.....	11
Low Pressure (Less than or equal to 2.0 PSI Natural Gas).....	11
Low Pressure (Less than or equal to 2.0 PSI) LP Gas	11
Elevated Pressure (10 PSI) LP Gas	12

Chapter 4: Installation Practices

4.1 Installation Practices and Guidelines.....	14
4.2 Trenching	15
4.3 Fitting Assembly Overview.....	16
4.4 Pressure and Leak Testing	18
Troubleshooting Fitting Assembly and Correcting Leaks	18

Chapter 5: Sizing/Capacity Tables

5.1 Fitting Adjustment Values for Determining Run Length.....	20
5.2 Natural Gas Sizing Tables.....	21
Less than 2 PSI with 0.3 in. w.c. drop.....	21
Less than 2 PSI with 0.5 in. w.c. drop.....	22
2 PSI with 1 PSI drop.....	23
5.3 Liquid Petroleum (LP) Gas Sizing Tables.....	24
Less than 11 in. w.c. with 0.5 in. w.c. drop.....	24
2 PSI with 1 PSI drop.....	25
10 PSI with 1 PSI drop	26

Chapter 1: Introduction

This side of the HOME-FLEX® manual applies to HOME-FLEX Underground® pipe and its associated plastic fittings. **HOME-FLEX® CSST and HOME-FLEX Underground® are two different systems with different uses and installation requirements. The tubing and fittings are not interchangeable.**

HOME-FLEX Underground pipe is made of a yellow poly plastic all the way through. It has a smooth outside wall and a smooth inside wall. The fittings are made of plastic. HOME-FLEX Underground gas pipe and fittings are for use with natural gas and LP (propane) gas. This poly gas pipe must be installed outdoors and underground only. The plastic pipe may never be used above ground, in a building or under a building.

1.1 Introduction

HOME-FLEX® CSST and HOME-FLEX Underground® are two different systems with different uses and installation requirements. The tubing and fittings are not interchangeable.

An installer must be aware of all of the HOME-FLEX Underground installation instructions and knowledgeable in all applicable plumbing and building codes. HOME-FLEX Underground installation practices and guidelines are found in this manual, packaged with each HOME-FLEX Underground fitting and on the HOME-FLEX Underground website, homeflexunderground.com.

HOME-FLEX Underground gas pipe is Medium Density Polyethylene (MDPE) gas pipe. It is also referred to as PE or poly gas pipe. It is made in accordance with the ASTM D2513 standard. It is approved for direct burial into the ground in accordance with the local plumbing code at the installation location. It is flexible, lightweight, easy to work with and easy to install. Unlike metallic gas pipe, it will not rust or corrode when properly installed. HOME-FLEX Underground PE gas pipe is iron pipe size (IPS). It is approved for use with Natural Gas or LP gas. It is never to be installed in a building or house. It is never to be installed under a building or house. It is never to be installed above grade.

HOME-FLEX Underground fittings are approved for direct burial. They can be installed without the need for special tools or equipment. HOME-FLEX Underground fittings are constructed of plastic and they are a compression type fitting. Once installed, they can be removed and reinstalled as long as they have not been damaged in any way.

HOME-FLEX Underground couplers, elbows and tees are approved to the ASTM F1924 standard. They may be used with any brand of properly sized ASTM D2513 Yellow Poly Gas Pipe. These fittings are sized for IPS Poly Gas Pipe in ½" (SDR 9.3), ¾" (SDR 11), 1" (SDR 11), 1¼" (SDR 11), 1½" (SDR 11) and 2" (SDR 11) diameters. They are approved for use with Natural Gas or LP Gas. You must verify that your local jurisdiction allows the use of F1924 fittings prior to performing your installation. The Transition Fittings and Risers are approved to ASTM F1973. HOME-FLEX Underground gas pipe is approved ASTM D2513.

The HOME-FLEX Underground® Gas Distribution System must be installed by a trained installer who meets the following criteria:

- 1. Installer must meet all qualifications required by the state and/or local administrative authority administering the provisions of the code where the gas piping is installed.**
- 2. An installer must also be informed in the use of HOME-FLEX Underground® Gas Distribution System. Information regarding Valencia Pipe Company's HOME-FLEX Underground® system can be obtained by reading the HOME-FLEX Underground® Gas Distribution System Installation/Training Guide and registering with Valencia Pipe Company. To obtain a Registered Installer Card, register online at homeflexunderground.com. In submitting the online registration, you are affirming that you understand all aspects of the installation requirements and local**

Introduction

plumbing, mechanical, electrical, and/ or applicable building codes. If you do not understand all requirements and local codes, contact a licensed professional plumber.

The installation shall be made in accordance with local codes, or, in the absence of local codes, in accordance with the National Fuel Gas Code (ANSI Z223.1 / NFPA 54); the Liquefied Petroleum Gas Code (NFPA 58); Natural Gas and Propane Installation Code (CSA B149.1); the International Fuel Gas Code (IFGC), or the Uniform Plumbing Code (UPC). In addition, ASTM D2774 (Standard Practice for Underground Installation of Thermoplastic Pressure Piping) and the installation instructions as prescribed by Valencia Pipe Company must be followed.

Special attention must be given to the proper design, installation, testing and use of the gas piping. Sound engineering principles and practices must be exercised as well as diligent adherence to proper installation procedures. All installed systems must pass customary installation inspections by the administrative authority having jurisdiction prior to being placed in service.

1.2 User Warnings

- ⚠ *When a conflict exists between this guide and local code requirements; the local codes shall take precedence.*
- ⚠ *Improper installation or operation of the gas piping system may result in fire, explosion or asphyxiation.*
- ⚠ *Only components provided or specified by Valencia Pipe Company as part of the HOME-FLEX Underground® Gas Distribution System are to be used in the installation.*
- ⚠ *The installation instructions and practices outlined in this training guide only apply to the use of HOME-FLEX Underground® Gas Distribution System. Valencia Pipe Company assumes no responsibility for installations made with other manufacturer's gas piping systems.*



**WARNING! THIS PRODUCT IS FOR
UNDERGROUND USE ONLY.**



Always call 811 prior to digging.



**Know what's below.
Call 811 before you dig.**



WARNING!

Improper installation or operation of the system may result in fire, explosion or asphyxiation. Only the components provided or specified by Valencia Pipe Company, for use as part of the fuel gas system are to be used in the installation.

1.3 Limitations of Manual

While every effort has been made to prepare this document in accordance with all regional model codes in effect at its printing, Valencia Pipe Company cannot guarantee that the local administrative authority will accept this. It is the ultimate responsibility of the installer to determine the suitability and acceptance of any building components including gas piping. Valencia Pipe Company, manufacturer of HOME-FLEX Underground® Gas Distribution System, assumes no responsibility for labor or material for installations made without prior determination of local code authority acceptance.

1.4 Applicable Codes and Standards

- NFPA 54/ANSI Z223.1 - National Fuel Gas Code
- NFPA 58 - Liquefied Petroleum Gas Code
- ICC - International Fuel Gas Code
- IAPMO - Uniform Plumbing Code



Items marked with the UPC logo are IAPMO certified for the United States.

1.5 Prohibited Installation Practices

- ⚠ **DO NOT** install HOME-FLEX Underground Products in above ground installations.
- ⚠ **DO NOT** install HOME-FLEX Underground Products inside buildings.
- ⚠ **DO NOT** install HOME-FLEX Underground Products under buildings.
- ⚠ **DO NOT** encase HOME-FLEX Underground Products inside concrete.
- ⚠ **DO NOT** connect HOME-FLEX Underground fittings to poly gas pipes other than the specified size (including SDR) marked on the fitting.



Valencia Pipe Company

28839 Industry Drive Phone: 661-257-4403

Valencia CA 91355

Fax: 661-257-3928

Email: info@homeflex.com

www.homeflexunderground.com

Copyright © 2019, Valencia Pipe Company. HOME-FLEX Underground® and the VPC logo are registered trademarks of Valencia Pipe Company, Inc. All rights reserved. The 811 logo is a registered trademark of the CGA. 1901/B

Chapter 2: Description of System Components

2.1 Gas Pipe

Application Information

For use in direct burial Natural Gas and Liquefied Petroleum (LP) Gas applications with Polyethylene (PE) gas pipelines.

Technical Data

Materials	
Pipe: Polyethylene (PE 2406/2708)	
Pressure Ratings	Temperature Ratings
Max Operating Pressure: 80 PSIG	Operating Temperature Range: 0°F - 140°F
Codes	Standards
NFPA 54/ANSI Z223.1 NFPA 58 International Fuel Gas Code Uniform Plumbing Code	ASTM D2513 NSF/ANSI 14 Certified

Dimensional Information

Part Series	Size (IPS)	SDR	Dimensions (in)			Min Bend Radius
			Av. OD	Approx. ID	Min Wall Thick	
19-0593XXX	½"	9.3	0.840	0.660	0.090	17.00"
19-0711XXX	¾"	11	1.050	0.860	0.095	26.25"
19-1011XXX	1"	11	1.315	1.075	0.120	30.00"
19-1211XXX	1¼"	11	1.660	1.358	0.151	41.50"
19-1511XXX	1½"	11	1.900	1.554	0.173	47.50"
19-2011XXX	2"	11	2.375	1.943	0.216	59.40"

Part Number Listing

	Part No.	Size (IPS)	SDR	Length
	19-0593100	½"	9.3	100'
	19-0593250	½"	9.3	250'
	19-0593500	½"	9.3	500'
	19-0711100	¾"	11	100'
	19-0711250	¾"	11	250'
	19-0711500	¾"	11	500'
	19-1011100	1"	11	100'
	19-1011250	1"	11	250'
	19-1011500	1"	11	500'

	Part No.	Size (IPS)	SDR	Length
	19-1211100	1¼"	11	100'
	19-1211250	1¼"	11	250'
	19-1211500	1¼"	11	500'
	19-1511100	1½"	11	100'
	19-1511250	1½"	11	250'
	19-1511500	1½"	11	500'
	19-2011100	2"	11	100'
	19-2011250	2"	11	250'
	19-2011500	2"	11	500'

Check homeflexunderground.com for up-to-date product listings.

2.2 Fittings

Application Information

Gas compression fittings for use in Natural Gas and Liquefied Petroleum (LP) Gas applications with Polyethylene (PE) gas pipelines.

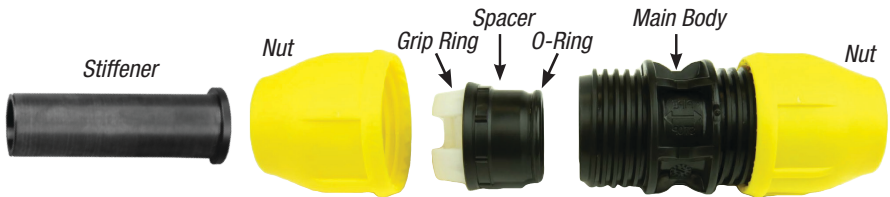







Technical Data

Materials	
Nut and Main Body: Polypropylene (PP) Spacer: Nylon	O-Ring: Nitrile Grip Ring & Stiffener: Acetal
Pressure Ratings	Temperature Ratings
Max Operating Pressure: 125 PSIG	Operating Temperature Range: -20°F - 180°F
Codes	Standards
NFPA 54/ANSI Z223.1 International Fuel Gas Code Uniform Plumbing Code	ASTM F1924

Part Number Listing

	Part No.	Description	SDR
	18-429-005	½" x ½" Coupling Fitting	9.3
	18-429-101	½" CTS x ½" IPS Coupling Fitting	9.3
	18-429-007	¾" x ¾" Coupling Fitting	11
	18-429-010	1" x 1" Coupling Fitting	11

	Part No.	Description	SDR
 	18-429-012	1¼" x 1¼" Coupling Fitting	11
	18-429-015	1½" x 1½" Coupling Fitting	11
	18-429-020	2" x 2" Coupling Fitting	11
 	18-406-005	½" x ½" Elbow Fitting	9.3
	18-406-007	¾" x ¾" Elbow Fitting	11
	18-406-010	1" x 1" Elbow Fitting	11
	18-406-012	1¼" x 1¼" Elbow Fitting	11
	18-406-015	1½" x 1½" Elbow Fitting	11
	18-406-020	2" x 2" Elbow Fitting	11
 	18-401-005	½" x ½" x ½" Tee Fitting	9.3
	18-401-007	¾" x ¾" x ¾" Tee Fitting	11
	18-401-010	1" x 1" x 1" Tee Fitting	11
	18-401-012	1¼" x 1¼" x 1¼" Tee Fitting	11
	18-401-015	1½" x 1½" x 1½" Tee Fitting	11
	18-401-020	2" x 2" x 2" Tee Fitting	11

Check homeflexunderground.com for up-to-date product listings.

Coupling Fitting Dimensional Information

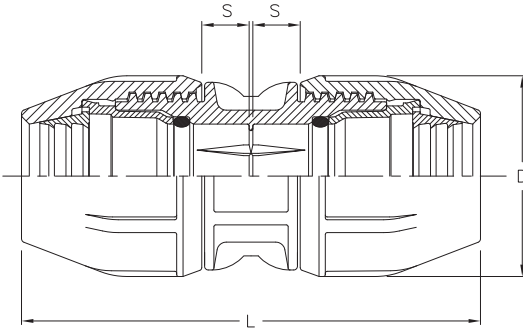

Part Number	Size (IPS)	SDR	Dimensions (in)			Weight (lbs)
			S	D	L	
18-429-005	½"	9.3	0.39	1.81	4.37	0.18
18-429-007	¾"	11	0.43	2.13	4.69	0.29
18-429-010	1"	11	0.55	2.68	5.75	0.46
18-429-012	1¼"	11	0.71	3.23	7.17	0.93
18-429-050	1½"	11	0.94	3.78	8.07	1.30
18-429-020	2"	11	1.14	4.44	9.17	1.96

Check homeflexunderground.com for up-to-date product listings.

Elbow Fitting Dimensional Information

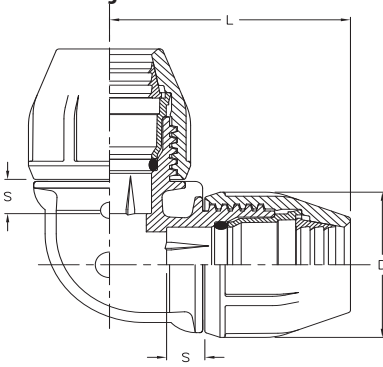

Part Number	Size (IPS)	SDR	Dimensions (in)			Weight (lbs)
			S	D	L	
18-406-005	½"	9.3	0.47	1.81	2.72	0.20
18-406-007	¾"	11	0.51	2.13	3.23	0.33
18-406-010	1"	11	0.63	2.68	3.78	0.57
18-406-012	1¼"	11	0.79	3.23	4.41	0.99
18-406-050	1½"	11	0.83	3.78	4.84	1.48
18-406-020	2"	11	0.94	4.45	5.59	2.29

Check homeflexunderground.com for up-to-date product listings.

Tee Fitting Dimensional Information

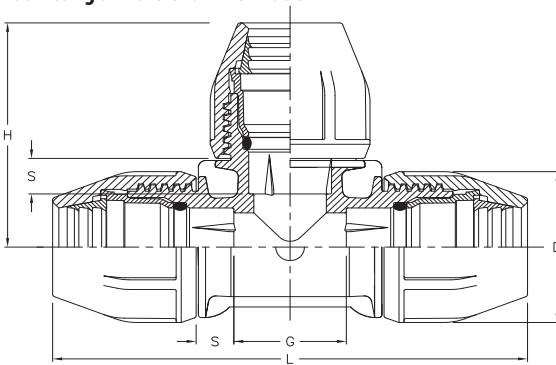

Part Number	Size (IPS)	SDR	Dimensions (in)					Weight (lbs)
			S	D	H	G	L	
18-406-005	½"	9.3	0.47	1.81	2.76	1.10	5.51	0.29
18-406-007	¾"	11	0.51	2.13	3.19	1.54	6.34	0.49
18-406-010	1"	11	0.63	2.68	3.78	1.69	7.44	0.86
18-406-012	1¼"	11	0.79	3.23	4.41	1.89	8.78	1.46

Part Number	Size (IPS)	SDR	Dimensions (in)					Weight (lbs)
			S	D	H	G	L	
18-406-015	1½"	11	0.83	3.78	4.88	2.17	9.65	2.16
18-406-020	2"	11	0.94	4.45	5.59	2.72	11.1	3.33

Check homeflexunderground.com for up-to-date product listings.

2.3 Transition Fittings

- Transitions between Steel and MDPE Gas Pipe
- Requires the use of a Coupling Fitting
- Complies with ASTM F1973 for use with ASTM D2513 Gas Pipe
- Suitable for Natural Gas or LP Gas
- Maximum Operating Pressure: 80 PSIG
- Operating Temperature Range: 0°F - 140°F

Note: The steel portion of this fitting has an epoxy coating to protect it from underground rust and corrosion. Inspect this coating carefully after installation. If any part of this coating has been nicked, chipped, or scratched, apply a rust proof coating or wrap with anti-corrosion tape. Be sure that no bare metal is exposed before burying.

	Part No.	Description	SDR
	18-445-005	½" IPS to ½" MIP	9.3
	18-445-007	¾" IPS to ¾" MIP	11
	18-445-010	1" IPS to 1" MIP	11
	18-445-012	1¼" IPS to 1¼" MIP	11
	18-445-015	1½" IPS to 1½" MIP	11
	18-445-020	2" IPS to 2" MIP	11

Check homeflexunderground.com for up-to-date product listings.

2.4 Anodeless Service Riser

- Required when bringing MDPE Gas Pipe above ground
- 30-inch rise from bottom of trench to top of pipe threads
- Requires the use of a Coupling Fitting
- Complies with ASTM F1973
- Complies with ASTM D2513 - Category 1 Specifications
- Suitable for Natural Gas or LP Gas
- Maximum Operating Pressure: 80 PSIG
- Operating Temperature Range: 0°F - 140°F

Note: The steel portion of this fitting has an epoxy coating to protect it from underground rust and corrosion. Inspect this coating carefully after installation. If any part of this coating has been nicked, chipped, or scratched, apply a rust proof coating or wrap with anti-corrosion tape. Be sure that no bare metal is exposed before burying.

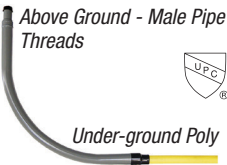
	Part No.	Description	SDR
 <p>Above Ground - Male Pipe Threads</p> <p>Under-ground Poly</p> <p>UPC®</p>	18-440-705	½" IPS poly to ¾" MIP	9.3
	18-440-007	¾" IPS poly to ¾" MIP	11
	18-440-010	1" IPS poly to 1" MIP	11
	18-440-012	1¼" IPS poly to 1¼" MIP	11
	18-440-015	1½" IPS poly to 1½" MIP	11
	18-440-020	2" IPS poly to 2" MIP	11

Check homeflexunderground.com for up-to-date product listings.

Chapter 3: System Configuration and Sizing

3.1 Configuration

Prior to piping installation, refer to building plans or prepare a sketch (this may be required by the local authority having jurisdiction for permitting purposes) showing the location of the appliances, the various appliance load demands, point of delivery (gas meter or 2nd stage LP regulator) and planned piping routes. Appliance load demand data can be obtained from the manufacturer's name-plate located on each appliance, or provided to the system designer by the builder/contractor.

Determine local piping restrictions prior to installing the underground piping system. Confirm that the AHJ (local authority having jurisdiction) has accepted the use of medium density polyethylene (MDPE listed to ASTM D2513) gas piping and fittings listed to ASTM F1924 . MDPE has been accepted by most major code bodies, but state and/or local adoptions of these codes often lag behind.

Determine metered supply pressure:

- Natural Gas: Check with local gas utility to determine pressure supplied by the meter.
- Liquefied Petroleum Gas (LP Gas, also called Propane): Check with LP supplier to determine pressure supplied by the first and second stage regulators.

Informational Notes:

- Natural gas pressures: Typical natural gas appliances require 5 inches of water column (inches of water column is a measurement of pressure that uses a different scale to more accurately measure low pressure gas – i.e. $\frac{1}{4}$ PSI = 6.921 inches of water column). In the past, standard low pressure was typically provided at 6-7 inches of water column by the meter (and still is in many places) thus allowing for a 1" WC pressure drop. With the popularity of on-demand water heaters, commercial type cook stoves, and gas appliances in general, many utilities now provide 2 PSI of pressure from the outlet of the meter. Because there is no national standard for meter outlet pressures, it is critical to contact the utility to determine the pressure. Please note that when the outlet pressure of the meter is 2 PSI a line pressure regulator must be placed in the piping system upstream from the connection of a manifold or appliance.
- LP gas: Check with both the AHJ and LP supplier for their acceptance of MDPE piping.

Determine the total capacity needed for all appliances. The capacity tables within this guide should be used to determine pipe sizes necessary to meet BTUH input load requirements.

With respect to gas pipe sizing, the intent of all model codes is to ensure there is sufficient gas volume and gas pressure supplied to the appliance for proper operation. Language from the International Fuel Gas Code clearly illustrates this point:

***Allowable Pressure Drop:** The design pressure loss on any piping system under maximum probable flow conditions, from the point of delivery to the inlet connection of the equipment, shall be such that supply pressure at the equipment is greater than the minimum required for proper equipment operation.*

Important Considerations:

- All existing pipe sizes within a gas piping system should be evaluated and confirmed to be adequate to handle the additional load when adding additional appliances.
- Allowable pressure drop along any particular run may be dictated by local code restrictions.
- Call 811 at least 3 days prior to digging.

3.2 Reference Data for Proper Sizing

Table 3.1 Pressure Conversion Factors
¼ PSI = 6.921 in. w.c. (approx. 7 in. w.c.)
½ PSI = 13.842 in. w.c. (approx. 14 in. w.c.)
1 PSI = 27.684 in. w.c. (approx. 28 in. w.c.)
2 PSI = 55.368 in. w.c. (approx. 56 in. w.c.)
5 PSI = 138.42 in. w.c. (approx. 40 in. w.c.)

Table 3.2 Fuel Gas Information		
Gas Type	BTU per Cubic Foot	Specific Gravity
Natural Gas	1000	0.6
LP Gas	2516	1.52

Note: To determine the CFH of Natural Gas, divide BTU load by 1000. To determine CFH of LP, divide the BTU load by 2516.

3.3 Sizing Methods and Examples

Low Pressure (Less than or equal to 2.0 PSI Natural Gas)

In this scenario, an underground polyethylene gas line is being ran from the low pressure outlet of the meter to a detached garage, outbuilding, or appliance that requires a natural gas outlet.

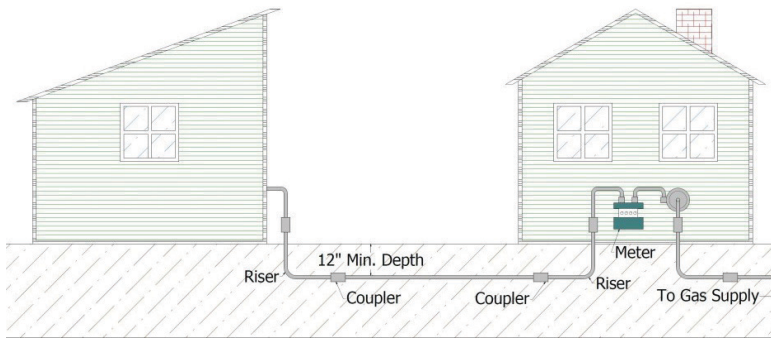

Figure 3.1 2 PSI Natural Gas Supply from House to Garage

Step 1 Call 811 at least 3 days prior to digging to have any underground utilities marked prior to digging.

Step 2 Determine length of gas piping from connection point at meter outlet to riser outlet at the out building or appliance. Include the distance required to connect the riser to the gas piping system near the meter. This connection must be made using rigid pipe or CSST that is at least the same size as the PE pipe size.

Step 3 Determine the number and type of HOME-FLEX Underground® fittings that are required in the system. Add the equivalent number of feet from Table 5.1 "Length to Add to Each Run for Each Fitting" on page 20 of this guide to the number of feet calculated above.

Step 4 Determine the appropriate sizing table in Chapter 5 based on meter outlet pressure and allowable pressure drop. For example, Table 5.2 on page 21 can be used for low pressure with a pressure drop of 0.3" w.c. Find the nearest length that is equal to or greater than the length calculated in step 3 above. Follow the row across until the number of BTU's provided is equal to or greater than the required BTU's required for this run- check the column header for required pipe diameter.

Low Pressure (Less than or equal to 2.0 PSI) LP Gas

In this scenario, an underground polyethylene gas line is being run from the outlet of the second-stage regulator to a detached garage, outbuilding, or appliance that requires an LP gas outlet.

System Configuration and Sizing

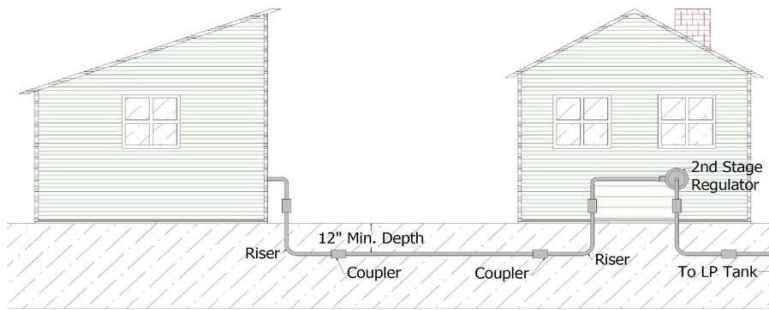

Figure 3.2 2 PSI LP Gas Second-Stage Regulator To Garage, Outbuilding Or Appliance.

Step 1 Call 811 at least 3 days prior to digging to have any underground utilities marked prior to digging.

Step 2 Determine length of gas piping from connection point at second stage regulator outlet to riser outlet at the outbuilding or appliance. Include the distance required to connect the riser to the gas piping system near the meter. This connection must be made using rigid pipe or CSST that is at least the same size as the PE pipe size.

Step 3 Determine the number and type of HOME-FLEX Underground® fittings that are required in the system. Add the equivalent number of feet from Table 5.1 “Length to Add to Each Run for Each Fitting” on page 20 of this guide to the number of feet calculated above.

Step 4 Determine the appropriate LP Gas sizing table based on the Second-Stage Regulator pressure and allowable pressure drop using the appropriate sizing table in Chapter 5. For example, Table 5.5 on page 24 can be used for low pressure LP gas with a pressure drop of 0.5" w.c. Find the nearest length that is equal to or greater than the length calculated in step above. Follow the row across until the number of BTU's provided is equal to or greater than the required BTU's required for this run- check the column header for required pipe diameter.

Elevated Pressure (10 PSI) LP Gas

In this scenario, an underground polyethylene gas line is being run from the outlet of the LP Gas tank's First-Stage Regulator to the Second-Stage Regulator.

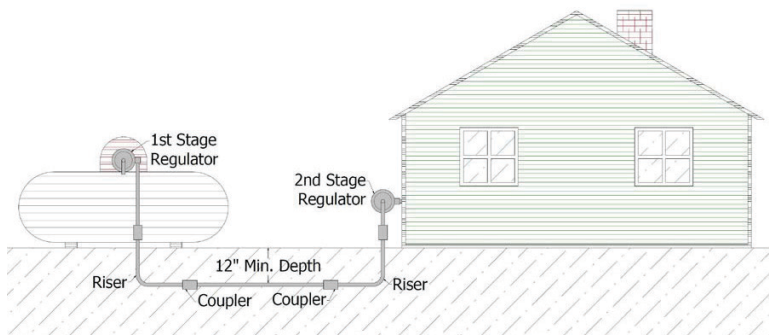

Figure 3.3 10 PSI LP Gas First-Stage Regulator (Tank) to Second-Stage Regulator (House)

Step 1 Call 811 at least 3 days prior to digging to have any underground utilities marked prior to digging.

Step 2 Determine length of gas piping from connection point of riser near first-stage regulator outlet to riser outlet at the second stage-regulator. LP provider will make connection from first stage regulator to riser.

Step 3 Determine the number and type of HOME-FLEX Underground® fittings that are required in the system. Add the equivalent number of feet from Table 5.1 “Length to Add to Each Run for Each Fitting” on page 20 of this guide to the number of feet calculated above.

Step 4 Use Table 5.7 on page 26 for 10 PSI elevated pressure LP Gas. Find the nearest length that is equal to or greater than the length calculated in step 3 above. Follow the row across until the number of BTU’s provided is equal to or greater than the required BTU’s required for this run - check the column header for required pipe diameter.

Chapter 4: Installation Practices

4.1 Installation Practices and Guidelines

1. HOME-FLEX Underground pipe and fittings must be installed in accordance with the Installation Practices & Guidelines outlined in this document as well as all local plumbing, mechanical, electrical and/or building codes and laws applicable at the locale where HOME-FLEX Underground is to be installed. If you do not understand all aspects of the installation requirements and local codes, locate a qualified installer in your area who does.
2. Only the components provided or specified by Valencia Pipe Company as part of the piping system are to be used in the installation.
3. Never use HOME-FLEX Underground products in above-ground applications.
4. Never use HOME-FLEX Underground products inside buildings.
5. Never install HOME-FLEX Underground pipe or fittings under a building.
6. Never encase HOME-FLEX Underground products in concrete.
7. Do not use HOME-FLEX Underground pipe fittings to connect poly gas pipes other than the specified size as marked on the fitting.
8. The minimum required depth for buried pipe will be specified by local code. If the local code does not include trench specifications, then trench and backfill in accordance with ASTM D2774 "Standard Practice for Underground Installation of Thermoplastic Pressure Piping" available at: astm.org/Standard/standards-and-publications.html. Consult Section 4.2 (p. 15) for more trenching guidelines.
9. Underground gas piping must be installed with sufficient clearance from any other underground structure to avoid contact, to allow maintenance, and to protect against damage from proximity to other structures. In addition, underground plastic piping shall be installed with sufficient clearance, or shall be insulated from any source of heat so as to prevent heat from impairing the serviceability and reliability of the pipe.
10. Ensure that correct stiffener is used with the correct sized pipe (size is marked on stiffener).
11. Ensure the sizing on the fitting nut matches the sizing on the pipe being connected.
12. The fitting is supplied assembled and ready to use. If the fitting is disassembled, ensure all nut components are present and in the correct orientation as pictured in Figure 4.1 (p. 15).
13. When installing PE pipe care must be taken to avoid inducing excessive stresses to the pipe and fittings.
14. Excessive bending of plastic piping systems, particularly at joints, can exceed stress limits and result in failure. Pipe, when joined with fittings, shall be laid as true to line as possible, while taking into consideration that common PE gas pipe may expand or contract 1 inch for every 10° F of temperature change per each 100 foot section of pipe. Grading and backfilling must be carried out carefully to prevent uneven settlement and therefore excessive bending. Please refer to ASTM D2774 for additional information on backfilling.
15. The use of damaged pipe where the joint is being made must be avoided. If there is a cut or groove in the pipe that section should be cut out. Sealing performance can be affected by scored or damaged pipe, so caution should be taken if present on the pipe.
16. The HOME-FLEX Underground® gas piping system must be pressure tested for leaks in accordance with all local codes. In the absence of a specific local code that specifies the pressure test, refer to the latest edition of the National Fuel Gas Code NFPA 54 which

can be obtained from: catalog.nfpa.org/NFPA-54-C3324.aspx. Consult Section 4.4 (p. 18) for more information on pressure / leak tests and troubleshooting leaks.



Figure 4.1 Fitting Re-assembly Diagrams

4.2 Trenching

The minimum required depth for buried pipe will be specified by local code, and may range from as shallow as 12 inches to as deep as 24 inches. The width of the trench should be sufficient for the width of the widest fitting. A 12 inch wide trench will allow for sufficient clearance of the pipe and fittings. The bottom of the trench should be smooth and flat. The plumbing code requirements at the installation location must be followed.

Keep in mind that trench depth requirements are measured from ground level to the top of the piping system, including the fittings. For example, if the minimum required depth, or amount of cover, per code is 18 inches and 1-inch pipe is being installed, the trench depth will be a minimum of 20.68 inches (18 inches plus the fitting depth of 2.68 inches). Fitting depth information can be found in Section 2.2 (p. 5). Be sure that trenches comply with your local code requirements.

Underground Piping Detectability Requirements

In the trench next to the gas pipe, install a 14 gauge or thicker insulated copper tracer wire. This wire will make the underground routing of the poly gas pipe detectable from above ground. The ends of the tracer wire should follow the riser above ground and be visible for future use. Some locations may also require the installation of plastic caution tape to be buried in the trench several inches above the gas pipe. Consult the local code at the installation location to ensure compliance with piping detectability requirements.

Backfilling Trenches

If the local code does not include trench specifications, then prepare trenches and backfill in accordance with ASTM D2774 "Standard Practice for Underground Installation of Thermoplastic Pressure Piping," which can be downloaded from: astm.org/Standard/standards-and-publications.html. Ensure that the fill dirt is free of debris or rocks that could damage the pipe when the earth is compressed around it. Do not backfill

Installation Practices

the trench until after the pressure / leak test has been completed (see Section "4.4 Pressure and Leak Testing" on page 18) and the system has passed inspection by the local authority having jurisdiction (AHJ).

4.3 Fitting Assembly Overview

HOME-FLEX Underground® IPS fittings are for use with IPS sized yellow poly gas pipe that has been approved for use with natural gas and propane.

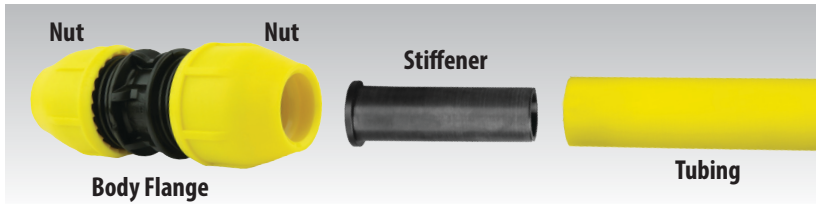

Step 1 Check contents

Each product package includes a fitting and a number of stiffeners to be used on each end of pipe being connected (i.e. 2 stiffeners for a Coupler or Elbow, 3 for a Tee).

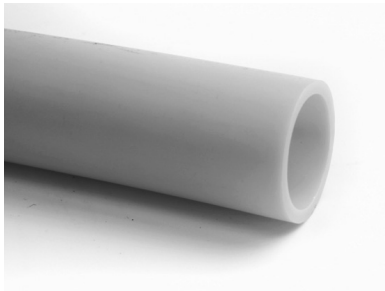

Step 2 Cut the pipe square

There is no need to chamfer the pipe end. Ensure any burrs on the pipe are removed and the pipe is clean.

Step 3 Insert stiffeners

Insert the supplied stiffeners into each end of the pipe being connected.



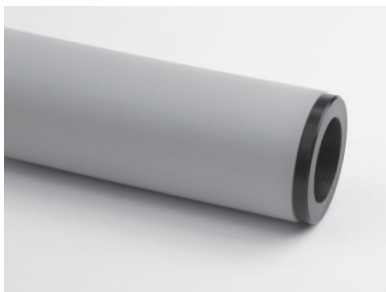

Step 4 Push stiffener into pipe

Push the stiffener all the way into the pipe until the ridge is flush with the pipe end. This can be done by hand, or gently tapped in with a mallet if required.

Step 5 Ensure 3 threads are showing on the fitting body

The fitting is supplied in a ready-to-use position. You do not need to disassemble the fitting prior to use. Always ensure three threads are exposed on the central body of the fitting prior to use.

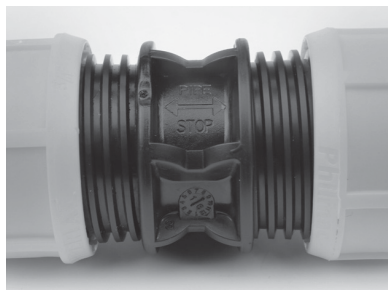

Step 6 Insert the pipe into the fitting

Gently slide the pipe with stiffener into the fitting until it stops. No force is required to do this. Do not try to force the pipe further into the fitting.



Step 7 Tighten the fitting

While holding the end of the pipe into the fitting with gentle force, tighten the nut until the nut touches the flange on the central body of the fitting. Do not tighten further once the nut touches the flange as over tightening can damage the fitting. It is recommended that pliers are used to ensure that the nut is tight against the body of the fitting.

Step 8 Fitting is installed

The fitting is now fully installed and ready for use. Note nut position relative to the flange on the central body. Check for system leaks prior to backfilling.



WARNING! Improper installation or operation of the system may result in fire, explosion, or asphyxiation. Only the components provided or specified by Valencia Pipe Company for use with HOME-FLEX Underground® or as part of the fuel gas system are to be used in the installation.

4.4 Pressure and Leak Testing

The HOME-FLEX Underground® gas piping system must be pressure tested for leaks in accordance with all local codes. The system must pass the pressure / leak test and have passed inspection by the authority having jurisdiction (AHJ) before backfilling the trench. In the absence of a specific local code that specifies the pressure test, refer to the latest edition of the National Fuel Gas Code NFPA 54. A copy of this code can be purchased and downloaded from: catalog.nfpa.org/NFPA-54-C3324.aspx.

Be sure that the new installation is isolated from any existing piping and the meter or regulator supply prior to conducting a pressure / leak test. A typical pressure / leak test for a single family residence might consist of pressurizing the newly installed pipe and fitting system with air to 15 PSI:

- Watch the needle on the pressure gauge for 15 - 30 minutes.
- If there is no detectable loss of pressure, this indicates that the system holds pressure.

NFPA 54 specifies that the system should be tested at 1.5 times the intended system operating pressure, but never less than 3 PSI. Long duration pressure / leak tests are not ideal, because the change of air temperature in the piping system will affect the reading on the pressure gauge. For each 10°F reduction in air temp, anticipate a 1.9% reduction in air pressure due to the cooling and contraction of the air in the pipe.

Troubleshooting Fitting Assembly and Correcting Leaks

If a leak is detected, check the following:

Step 1 Ensure that all yellow nuts on the fitting are tight up against the black body of the fitting. If they are and leak persists, go to step 2.

Step 2 Loosen the yellow nut and remove the pipe from the fitting.

- a) Examine the inside of the fittings to make sure it is free of dirt or any debris that will interfere with the outside of the pipe making a seal against the inside of the fitting.
- b) Make sure that the outside of the pipe is clean and smooth.
- c) Reassemble the pipe into the fitting follow the assembly instructions and check for leaks.

Note: It is not necessary to remove the yellow nut completely off of the fitting. If this occurs refer to Figure 4.1 (p. 15).

Chapter 5: Sizing/Capacity Tables

Fitting Adjustment Values for Determining Run Length

Table 5.1 Length to Add to Each Run for Each Fitting20

Natural Gas Sizing Tables

Table 5.2 Low Pressure Natural Gas (Less than 2 PSI with 0.3 in. w.c. drop)21

Table 5.3 Low Pressure Natural Gas (Less than 2 PSI with 0.5 in. w.c. drop)22

Table 5.4 Elevated Pressure Natural Gas (2 PSI with 1 PSI drop)23

Liquid Petroleum (LP) Sizing Tables

Table 5.5 Low Pressure LP (Less than 11 in. w.c. with 0.5 in. w.c. drop)24

Table 5.6 Elevated Pressure LP (2 PSI with 1 PSI drop)25

Table 5.7 Elevated Pressure Liquid Propane (LP) (10 PSI with 1 PSI drop)26

5.1 Fitting Adjustment Values for Determining Run Length

Table 5.1 Length to Add to Each Run for Each Fitting

Fitting	Pipe Size	Add
Coupler	½"	1.6'
	¾"	2.2'
	1"	2.9'
	1¼"	3.5'
	1½"	4.2'
	2"	3.4'
Elbow	½"	3.2'
	¾"	4.4'
	1"	5.7'
	1¼"	6.9'
	1½"	8.2'
	2"	8.3'
Tee (In Line Flow)	½"	2.1'
	¾"	2.9'
	1"	3.7'
	1¼"	4.5'
	1½"	5.3'
	2"	4.8'
Tee (line to branch flow)	½"	3.8'
	¾"	5.3'
	1"	6.8'
	1¼"	8.4'
	1½"	9.9'
	2"	10.4'

5.2 Natural Gas Sizing Tables

Table 5.2 Low Pressure Natural Gas (Less than 2 PSI with 0.3 in. w.c. drop)

Maximum Capacity of HOME-FLEX Underground® Poly Pipe in BTU/h (British Thermal Units per Hour) of Natural Gas by Length of Piping Run

(Approximate 1,000 BTU/h Natural Gas per 1 CFH; based on a 0.6 specific gravity of gas)

Inlet Pressure: **Less than 2 PSI**

Pressure Drop: **0.3 in w.c.**

Run (ft.)	IPS Pipe Size (SDR)					
	½" (SDR 9.3)	¾" (SDR 11)	1" (SDR 11)	1¼" (SDR 10)	1½" (SDR 11)	2" (SDR 11)
10	153k	305k	551k	955k	1,440k	2,590k
20	105k	210k	379k	656k	991k	1,780k
30	84k	169k	304k	527k	796k	1,430k
40	72k	144k	260k	451k	681k	1,220k
50	64k	128k	231k	400k	604k	1,080k
60	58k	116k	209k	362k	547k	983k
70	53k	107k	192k	333k	503k	904k
80	50k	99k	179k	310k	468k	841k
90	46k	93k	168k	291k	439k	789k
100	44k	88k	159k	275k	415k	745k
125	39k	78k	141k	243k	368k	661k
150	35k	71k	127k	221k	333k	598k
175	32k	65k	117k	203k	306k	551k
200	30k	60k	109k	189k	285k	512k
250	27k	54k	97k	167k	253k	454k
300	24k	48k	88k	152k	229k	411k
350	22k	45k	81k	139k	211k	378k
400	21k	42k	75k	130k	196k	352k
450	19k	39k	70k	122k	184k	330k
500	18k	37k	66k	115k	174k	312k

k = 1,000 BTU/h

EXAMPLE: 10k = 10,000 BTU/h = 10 CFH (Cubic Feet per Hour) of Natural Gas

Sizing/Capacity Tables

Table 5.3 Low Pressure Natural Gas (Less than 2 PSI with 0.5 in. w.c. drop)

Maximum Capacity of HOME-FLEX® Underground® Poly Pipe in BTU/h (British Thermal Units per Hour) of Natural Gas by Length of Piping Run

(Approximate 1,000 BTU/h Natural Gas per 1 CFH; based on a 0.6 specific gravity of gas)

Inlet Pressure: **Less than 2 PSI**

Pressure Drop: **0.5 in w.c.**

Run (ft.)	IPS Pipe Size (SDR)					
	½" (SDR 9.3)	¾" (SDR 11)	1" (SDR 11)	1¼" (SDR 10)	1½" (SDR 11)	2" (SDR 11)
10	201k	403k	726k	1,260k	1,900k	3,410k
20	138k	277k	499k	865k	1,310k	2,350k
30	111k	222k	401k	695k	1,050k	1,880k
40	95k	190k	343k	594k	898k	1,610k
50	84k	169k	304k	527k	796k	1,430k
60	76k	153k	276k	477k	721k	1,300k
70	70k	140k	254k	439k	663k	1,190k
80	65k	131k	236k	409k	617k	1,110k
90	61k	123k	221k	383k	579k	1,040k
100	58k	116k	209k	362k	547k	983k
125	51k	103k	185k	321k	485k	871k
150	46k	93k	168k	291k	439k	789k
175	43k	86k	154k	268k	404k	726k
200	40k	80k	144k	249k	376k	675k
250	35k	71k	127k	221k	333k	598k
300	32k	64k	115k	200k	302k	542k
350	29k	59k	106k	184k	278k	499k
400	27k	55k	99k	171k	258k	464k
450	26k	51k	93k	160k	242k	435k
500	24k	48k	88k	152k	229k	411k

k = 1,000 BTU/h EXAMPLE: 10k = 10,000 BTU/h = 10 CFH (Cubic Feet per Hour) of Natural Gas

Table 5.4 Elevated Pressure Natural Gas (2 PSI with 1 PSI drop)

Maximum Capacity of HOME-FLEX Underground® Poly Pipe in BTU/h (British Thermal Units per Hour) of Natural Gas by Length of Piping Run

(Approximate 1,000 BTU/h Natural Gas per 1 CFH; based on a 0.6 specific gravity of gas)

Inlet Pressure: **2 PSI**

Pressure Drop: **1 PSI**

Run (ft.)	IPS Pipe Size (SDR)					
	½" (SDR 9.3)	¾" (SDR 11)	1" (SDR 11)	1¼" (SDR 10)	1½" (SDR 11)	2" (SDR 11)
10	1,860k	3,720k	6,710k	11,600k	17,600k	31,600k
20	1,280k	2,560k	4,610k	7,990k	12,100k	21,700k
30	1,030k	2,050k	3,710k	6,420k	8,690k	17,400k
40	878k	1,760k	3,170k	5,490k	8,300k	14,900k
50	778k	1,560k	2,810k	4,870k	7,350k	13,200k
60	705k	1,410k	2,550k	4,410k	6,660k	12,000k
70	649k	1,300k	2,340k	4,060k	6,130k	11,000k
80	603k	1,210k	2,180k	3,780k	5,700k	10,200k
90	566k	1,130k	2,050k	3,540k	5,250k	9,610k
100	535k	1,070k	1,930k	3,350k	5,050k	9,080k
125	474k	949k	1,710k	2,970k	4,480k	8,050k
150	429k	860k	1,550k	2,690k	4,060k	7,290k
175	395k	791k	1,430k	2,470k	3,730k	6,710k
200	368k	736k	1,330k	2,300k	3,470k	6,240k
250	326k	652k	1,180k	2,040k	3,080k	5,530k
300	295k	591k	1,070k	1,850k	2,790k	5,010k
350	272k	544k	981k	1,700k	2,570k	4,610k
400	253k	506k	913k	1,580k	2,390k	4,290k
450	237k	475k	856k	1,480k	2,240k	4,020k
500	224k	448k	809k	1,400k	2,120k	3,800k
550	213k	426k	768k	1,330k	2,010k	3,610k
600	203k	406k	733k	1,270k	1,920k	3,440k
650	194k	389k	702k	1,220k	1,840k	3,300k
700	187k	374k	674k	1,170k	1,760k	3,170k
750	180k	360k	649k	1,130k	1,700k	3,050k
800	174k	348k	627k	1,090k	1,640k	2,950k
850	168k	336k	607k	1,050k	1,590k	2,850k
900	163k	326k	588k	1,020k	1,540k	2,770k
950	158k	317k	572k	990k	1,500k	2,690k
1000	154k	308k	556k	963k	1,450k	2,610k
1100	146k	293k	528k	915k	1,380k	2,480k
1200	139k	279k	504k	873k	1,320k	2,370k
1300	134k	267k	482k	836k	1,260k	2,270k
1400	128k	257k	463k	803k	1,210k	2,180k
1500	124k	247k	446k	773k	1,170k	2,100k
1600	119k	239k	431k	747k	1,130k	2,030k
1700	115k	231k	417k	723k	1,090k	1,960k
1800	112k	224k	404k	701k	1,060k	1,900k
1900	109k	218k	393k	680k	1,030k	1,850k
2000	106k	212k	382k	662k	1,000k	1,800k

k = 1,000 BTU/h

EXAMPLE: 10k = 10,000 BTU/h = 10 CFH (Cubic Feet per Hour) of Natural Gas

5.3 Liquid Petroleum (LP) Gas Sizing Tables

Table 5.5 Low Pressure LP (Less than 11 in. w.c. with 0.5 in. w.c. drop)
Maximum Capacity of HOME-FLEX Underground® Poly Pipe in BTU/h (British Thermal Units per Hour) of
Liquid Propane (LP) Gas by Length of Piping Run
 (Approximate 2,520 BTU/h LP Gas per 1 CFH; based on a 1.52 specific gravity of gas)
 Inlet Pressure: **11 in. w.c.** Pressure Drop: **0.5 in. w.c.**
 Intended Use: PE Pipe Sizing Between Integral Second-Stage Regulator at Tank or Second-Stage (Low-Pressure) Regulator and Building

Run (ft.)	IPS Pipe Size (SDR)					
	½" (SDR 9.3)	¾" (SDR 11)	1" (SDR 11)	1¼" (SDR 10)	1½" (SDR 11)	2" (SDR 11)
10	340k	680k	1,230k	2,130k	3,210k	5,770k
20	233k	468k	844k	1,460k	2,210k	3,970k
30	187k	375k	677k	1,170k	1,770k	3,180k
40	160k	321k	580k	1,000k	1,520k	2,730k
50	142k	285k	514k	890k	1,340k	2,420k
60	129k	258k	466k	807k	1,220k	2,190k
70	119k	237k	428k	742k	1,120k	2,010k
80	110k	221k	398k	690k	1,040k	1,870k
90	103k	207k	374k	648k	978k	1,760k
100	98k	196k	353k	612k	924k	1,660k
125	87k	173k	313k	542k	819k	1,470k
150	78k	157k	284k	491k	742k	1,330k
175	72k	145k	261k	452k	683k	1,230k
200	67k	135k	243k	420k	635k	1,140k
250	60k	119k	215k	373k	563k	1,010k
300	54k	108k	195k	338k	510k	916k
350	50k	99k	179k	311k	469k	843k
400	46k	92k	167k	289k	436k	784k
450	43k	87k	157k	271k	409k	736k
500	41k	82k	148k	256k	387k	695k

k = 1,000 BTU/h EXAMPLE: 252k = 252,000 BTU/h = 100 CFH (Cubic Feet per Hour) of LP Gas

Table 5.6 Elevated Pressure LP (2 PSI with 1 PSI drop)**Maximum Capacity of HOME-FLEX Underground® Poly Pipe in BTU/h (British Thermal Units per Hour) of
Liquid Propane (LP) Gas by Length of Piping Run**

(Approximate 2,520 BTU/h LP Gas per 1 CFH; based on a 1.52 specific gravity of gas)

Inlet Pressure: **2 PSI**Pressure Drop: **1 PSI**

Intended Use: PE Pipe Sizing Between 2 PSI Service Regulator and Line Pressure Regulator

Run (ft.)	IPS Pipe Size (SDR)					
	½" (SDR 9.3)	¾" (SDR 11)	1" (SDR 11)	1¼" (SDR 10)	1½" (SDR 11)	2" (SDR 11)
10	3,130k	6,260k	11,300k	19,600k	29,500k	53,100k
20	2,150k	4,300k	7,760k	13,400k	20,300k	36,500k
30	1,730k	3,450k	6,230k	10,800k	16,300k	29,300k
40	1,480k	2,690k	5,330k	9,240k	14,000k	25,100k
50	1,310k	2,620k	4,730k	8,190k	12,400k	22,200k
60	1,190k	2,370k	4,280k	7,420k	11,200k	20,100k
70	1,090k	2,180k	3,940k	6,830k	10,300k	18,500k
80	1,010k	2,030k	3,670k	6,350k	9,590k	17,200k
90	952k	1,910k	3,440k	5,960k	9,000k	16,200k
100	899k	1,800k	3,250k	5,630k	8,500k	15,300k
125	797k	1,600k	2,880k	4,990k	7,530k	13,500k
150	722k	1,450k	2,610k	4,520k	6,830k	12,300k
175	664k	1,330k	2,400k	4,160k	6,280k	11,300k
200	618k	1,240k	2,330k	3,870k	5,840k	10,500k
250	548k	1,100k	1,980k	3,430k	5,180k	9,300k
300	496k	994k	1,790k	3,110k	4,690k	8,430k
350	457k	914k	1,650k	2,860k	4,320k	7,760k
400	425k	851k	1,530k	2,660k	4,020k	7,220k
450	399k	798k	1,440k	2,500k	3,770k	6,770k
500	377k	754k	1,360k	2,360k	3,560k	6,390k
550	358k	716k	1,290k	2,240k	3,380k	6,070k
600	341k	683k	1,230k	2,140k	3,220k	5,790k
650	327k	654k	1,180k	2,040k	3,090k	5,550k
700	314k	628k	1,130k	1,960k	2,970k	5,330k
750	302k	605k	1,090k	1,770k	2,670k	4,800k
800	292k	585k	1,050k	1,830k	2,760k	4,960k
850	283k	566k	1,020k	1,770k	2,670k	4,800k
900	274k	549k	990k	1,710k	2,670k	4,800k
950	266k	533k	961k	1,670k	2,520k	4,520k
1000	259k	518k	935k	1,620k	2,450k	4,400k
1100	246k	492k	888k	1,540k	2,320k	4,170k
1200	234k	470k	847k	1,470k	2,220k	3,980k
1300	225k	450k	811k	1,410k	2,120k	3,810k
1400	216k	432k	779k	1,350k	2,040k	3,660k
1500	208k	416k	751k	1,300k	1,960k	3,530k
1600	201k	402k	725k	1,260k	1,900k	3,410k
1700	194k	389k	702k	1,220k	1,840k	3,300k
1800	188k	377k	680k	1,180k	1,780k	3,200k
1900	183k	366k	661k	1,140k	1,730k	3,110k
2000	178k	356k	643k	1,110k	1,680k	3,020k

k = 1,000 BTU/h EXAMPLE: 252k = 252,000 BTU/h = 100 CFH (Cubic Feet per Hour) of LP Gas

Sizing/Capacity Tables

Table 5.7 Elevated Pressure Liquid Propane (LP) (10 PSI with 1 PSI drop)

Maximum Capacity of HOME-FLEX Underground® Poly Pipe in BTU/h (British Thermal Units per Hour) of Liquid Propane (LP) Gas by Length of Piping Run

(Approximate 2,520 BTU/h LP Gas per 1 CFH; based on a 1.52 specific gravity of gas)

Inlet Pressure: **10 PSI**

Pressure Drop: **1 PSI**

Intended Use: PE Pipe Sizing Between First-Stage Pressure Regulator and Second-Stage (Low Pressure) Regulator

Run (ft.)	IPS Pipe Size (SDR)					
	½" (SDR 9.3)	¾" (SDR 11)	1" (SDR 11)	1¼" (SDR 11)	1½" (SDR 11)	2" (SDR 11)
30	2,140k	3,920k	7,740k	13,420k	20,300k	36,400k
40	1,840k	3,670k	6,630k	11,480k	17,300k	31,200k
50	1,630k	3,260k	5,870k	10,180k	15,400k	27,600k
60	1,470k	2,950k	5,320k	9,220k	13,900k	25,000k
70	1,360k	2,710k	4,900k	8,480k	12,800k	23,000k
80	1,260k	2,530k	4,560k	7,890k	11,900k	21,400k
90	1,180k	2,370k	4,270k	7,400k	11,200k	20,100k
100	1,120k	2,240k	4,040k	6,990k	10,600k	19,000k
125	990k	990k	3,580k	6,200k	9,360k	16,800k
150	897k	897k	3,240k	5,620k	8,480k	15,200k
175	826k	826k	2,980k	5,170k	7,800k	14,000k
200	778k	778k	2,780k	4,810k	7,260k	13,000k
225	721k	721k	2,600k	4,510k	6,810k	12,200k
250	681k	681k	2,460k	4,260k	6,430k	11,600k
275	646k	646k	2,340k	4,050k	6,110k	11,000k
300	617k	617k	2,230k	3,860k	5,830k	10,470k
350	567k	567k	2,050k	3,550k	5,360k	9,640k
400	528k	528k	1,910k	3,300k	4,990k	8,970k
450	495k	495k	992k	3,100k	4,680k	8,410k
500	468k	468k	937k	2,930k	4,420k	7,950k
600	424k	424k	849k	2,650k	4,010k	7,200k
700	390k	390k	781k	2,440k	3,690k	6,620k
800	363k	363k	726k	2,270k	3,430k	6,160k
900	340k	340k	682k	2,130k	3,220k	5,780k
1000	322k	322k	644k	2,010k	3,040k	5,460k
1500	258k	258k	517k	933k	1,616k	4,390k
2000	221k	221k	443k	498k	1,383k	3,750k

k = 1,000 BTU/h EXAMPLE: 252k = 252,000 BTU/h = 100 CFH (Cubic Feet per Hour) of LP Gas