

H Hulife Bidet
HLB-3000ER ELECTRONIC BIDET SEAT

Operating Instruction Manual

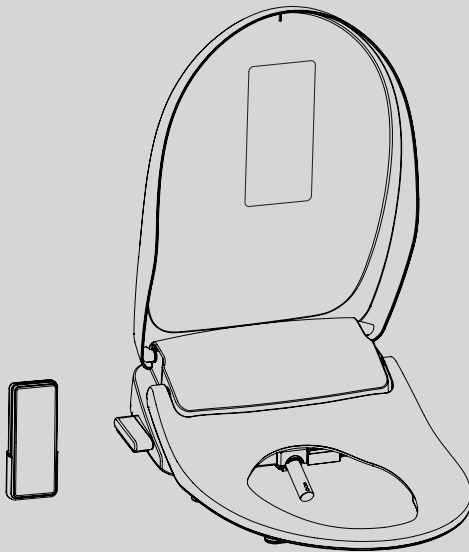

-
- Thank you for purchasing this Hulife bidet seat.
 - You are kindly requested to carefully read this operation manual for proper use of this appliance.
 - Please register warranty for proper service.
 - Please save this manual and place it in an easily accessible location.

READ ALL OPERATING INSTRUCTIONS BEFORE INSTALLATION.

Notes

- 1. This product should be installed according to this manual.*
- 2. Read this manual carefully and install properly.*
- 3. Retain this instruction manual in an easily accessible place.*
- 4. Do not attempt to service this appliance yourself. Doing so will void the warranty.*

PREPARATION

- 1 p1 *Important safeguards*
- 2 p1 *Cautions before installation*
- 3 p3 *Identification*
- 4 p4 *Safety information(DANGER)*
- 5 p6 *Safety information(WARNING)*

USE

- 6 p8 *How to install*
- 7 p11 *How to use*
p12 *User setting*
- 8 p13 *How to clean*
- 9 p14 *Maintenance*
- 10 p15 *Before calling for service*

ETC

- 11 p16 *Specifications*
- 12 p17 *Warranty*

1. Important Safeguards

1. READ ALL INSTRUCTIONS BEFORE USING

DANGER - To reduce the risk of electric shock:

1. Do not place or store this appliance in a location where it can fall or be pulled into a tub or sink.
2. Do not place in, or drop into water or other liquids.
3. Do not touch a product that has fallen into water. Unplug immediately.

WARNING - To reduce the risk of burns, electric shock, fire or injury.

1. Close supervision is necessary when this appliance is used by or is near infants, elders, or handicapped persons. Children should not be permitted to use or touch this appliance without adult supervision. Be sure to adjust the toilet seat's temperature for elders, handicapped persons, or people with sensitive skin.
2. Use this appliance only for its intended purpose as described in this manual. Do not use attachments not recommended by the manufacturer.
3. Do not operate this appliance if the cord is damaged or if the product is dropped into water.
4. Install the unit properly by following the installation procedure.
5. Only authorized persons can install or repair the unit. Do not attempt to service this appliance by yourself. Doing so could void the warranty.
6. Keep the cord away from heated surfaces.
7. Never drop or insert any objects into any opening or hose.
8. Do not use outdoors. Do not use aerosol or oxygen spray products on the unit.
9. Always follow the grounding instructions in this manual before plugging in the unit.

SAVE THESE INSTRUCTIONS

2. Cautions before installation

1. NOTE THE FOLLOWING IMPORTANT POINTS

1. Do not install in a location where water might be splashed on this appliance or in a location exposed to excessive moisture where condensation might form on the product's surface.
2. To avoid damage to electronic components due to high levels of humidity, provide adequate ventilation by opening a window and/or door when bathing.
3. Water supply should have a water pressure of 0.07MPa to 0.74MPa.
4. Connect the product to a pipe carrying potable water. Do not connect to an industrial water line or other water supplies that are not potable.
5. Cool the unit in the room before installation.
6. The thermal protector in the water tank may malfunction when transporting or storing warm water.
7. The rated power voltage is 120V AC, 60Hz.
8. Do not plug the unit in until installation is complete. It may result in malfunction.

2. Cautions before installation

2. WIRING REQUIREMENTS

1. Any other servicing should be performed by authorized service representatives.

2. GROUNDING INSTRUCTIONS

This product should be grounded. In the event of an electrical short circuit, grounding reduces the risk of electric shock by providing an escape wire for the electric current. This product is equipped with a cord having a grounding wire with a grounding plug. The plug must be plugged into an outlet that is properly installed and grounded.

DANGER-Improper use of the grounding plug can result in a risk of electric shock.

If the cord or plug is necessary to repair or needs to be replaced, do not connect the grounding wire to a flat blade terminal. The grounding wire can be identified by its insulated outer surface. It will either be colored green or will not contain yellow stripes.

Check with a qualified electrician or serviceman if you do not understand grounding instructions or if you do not know whether the product is properly grounded.

3. This product is for use on a nominal 120V circuit. It has a grounding plug that looks like the plug illustrated in sketch A. A temporary adapter, which looks like the adapter illustrated in sketches B and C, may be used to connect this plug with a 2-pole receptacle as shown in sketch B if a properly grounded outlet is not available. The temporary adapter should be used only until the properly grounded outlet (sketch A) can be installed by a qualified electrician. The green colored rigid ear lug and the like extending from the adapter must be connected to a permanent ground such as a properly grounded outlet box cover. Whenever the adapter is used, it must be held in place by the screw.

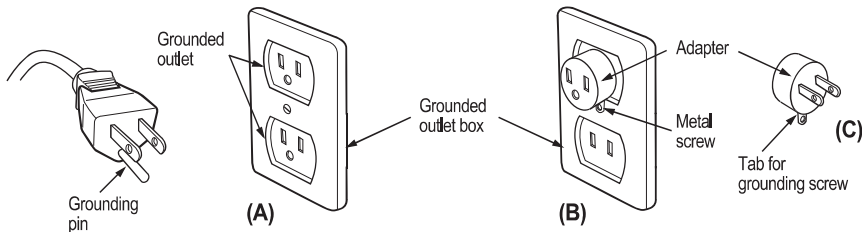

4. If it is necessary to use an extension cord, use only a three wire extension cord that has a three-blade grounding plug, and a three-slot receptacle that will accept the plug on the product. Replace or repair a damaged cord.

3. Identification

1. Main unit

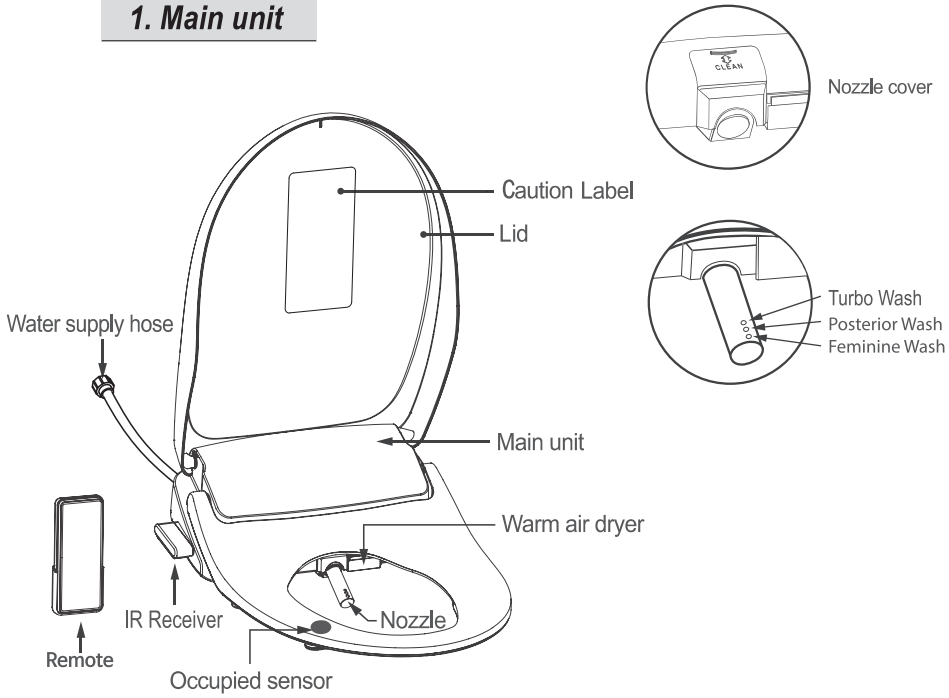

2. Accessories

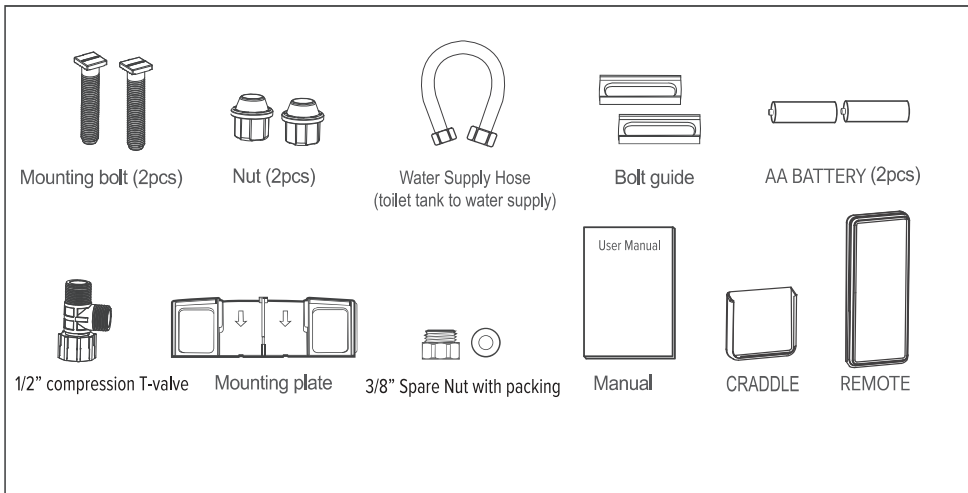

This appliance is connected with supply hose.

4. Safety Information(DANGER)



DANGER Follow these basic instructions to ensure the safe use of your appliance

Indicates a prohibited use of the appliance.

Indicates a required step in use of this appliance.



PROHIBITED



DO NOT HANDLE WITH WET HANDS



USE OF FIRE PROHIBITED



DO NOT DISASSEMBLE



DO NOT SPRAY WATER



GROUND CONNECTION



REQUIRED STEP



Meanings of symbols



PROHIBITED

Do not use a faulty or loose electric outlet or cord

■ Doing so may result in a short circuit, electric shock or fire.

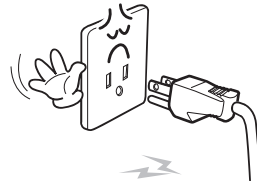

REQUIRED

Do not obstruct the warm air dryer outlet

■ If the outlet is obstructed with any objects, it may result in fire.
 ■ If the outlet is obstructed with hands, it may result in injury.



USE OF FIRE PROHIBITED

Do not throw anything flammable into the toilet

■ Doing so may result in fire.



DO NOT WASH

Do not splash water on this product

■ Doing so may result in fire or electric shock.



GROUND CONNECTION

This product must be grounded

■ Not doing so may result in short circuit, electric shock, or malfunction.





DANGER Follow these basic instructions to ensure the safe use of your appliance



PROHIBITED

Do not use too many appliances on one power strip

- Doing so may result in fire or damage.
- Be sure to use a dry and clean outlet.
- Do not use a faulty or loose outlet.

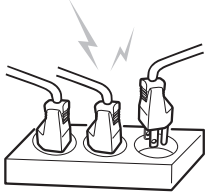

NO WET HANDS

Plug and unplug properly

- Do not plug or unplug with wet hands. It may result in injury or short circuit.
- Do not grab the cord when unplugging. Pull out the plug properly.

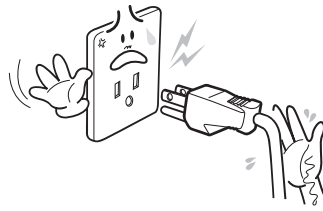

DO NOT DISASSEMBLE

Do not use when the seat and lid are disassembled

- Doing so may result in electric shock due to high voltage inside.



REQUIRED

Unplug when beeping or emitting a strange odor

- Unplug right away.
- Contact your dealer where you bought this appliance.



DO NOT DISASSEMBLE

Do not disassemble, repair or modify this appliance

- Doing so may result in fire or electric shock.



PROHIBITED

Use tap potable water only (ground water)

- Not doing so may cause irritation or injury.

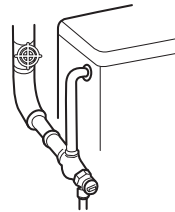

5. Safety Information(WARNING)



WARNING Follow these basic instructions to ensure the safe use of your appliance



PROHIBITED

Do not step on or place heavy objects on this appliance

- Doing so may damage the unit.
- Doing so may result in malfunction of appliance.



REQUIRED

Do not force the lid to close

- Doing so may cause malfunction.



REQUIRED

Be aware of urine splash on a nozzle or on a dry air outlet

- Doing so may result in unpleasant odor or failure of appliance.



PROHIBITED

Do not sit or lean against the lid or control panel

- Doing so may cause malfunction or breakage.



REQUIRED

Unplug if you do not plan to use for a long period of time

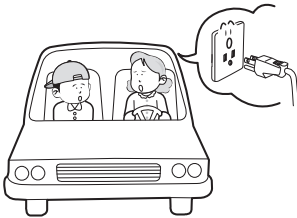

REQUIRED

Unplug while there is thunder or lightning





WARNING Follow these basic instructions to ensure the safe use of your appliance



Do not pull out the waterhose forcefully

PROHIBITED

- Doing so may cause water leakage.



Use this appliance on a toilet only

REQUIRED

- Not doing so may result in fire, injury or electric shock.



Improper use



Do not put a vase, water cup or small materials on this appliance

PROHIBITED



Be aware of low-grade burns

PROHIBITED

- Sitting on the heated seat for a long time may result in a low-grade burn.
- Use care when being used by the following:
 - Children, senior citizens, patients, or others who can not control the temperature level
 - Sleeping pill users or people who are on medication that causes drowsiness
 - Those who are intoxicated or very tired may fall asleep while sitting on the unit



Unplug when cleaning

REQUIRED

- Not doing so may result in fire or electric shock.

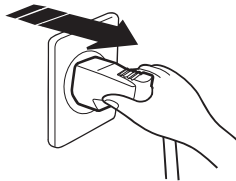

Use the low temperature for children and disabled

REQUIRED

- High temperature may result in burns due to not recognizing the temperature.

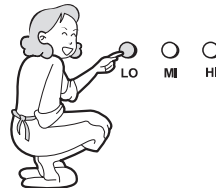

WARNING: Risk of electric shock, fire, or personal injury. This product must be grounded and connected only a dedicated, nominal 120 VAC, 60 Hz circuit protected by a minimum 15 A Ground-Fault Circuit-Interrupter (GFCI)

6. How to install



Do not plug in until installation is finished completely.
Not doing so may damage the appliance.

※ **If electric work is needed, please contact a qualified electrician or serviceman only.**

Remove the existing toilet lid and seat

1. Remove the nuts, washers and cone packings from the toilet seat mounting bolts in the back of the toilet.
2. Remove the toilet seat, lid and mounting bolts.
3. Keep them in case you need them.

Install the appliance

Installation

■ How to mount the plate

Place the base plate and bolt cases over each toilet mounting hole. Insert the mounting bolts through the base plate and toilet mounting holes. Screw in the nuts onto the mounting bolts.

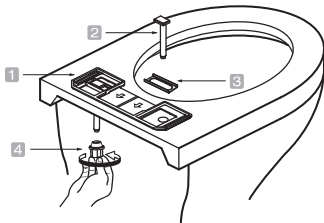

- 1 Mounting plate
2 Mounting bolt
3 Bolt guide
4 Nut

■ How to attach and detach the unit

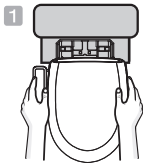

Slide the unit until it clicks into plate.



Lift the unit up and forward.

Toilet size (Elongated)

■ The toilet dimensions must be within those shown below. Do not install this appliance on a toilet that does not meet those dimensional requirements.

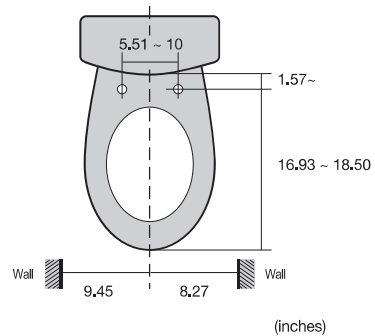

Occupied sensor

- This appliance is equipped with occupied sensor.
- Unit will not work unless seat is occupied.

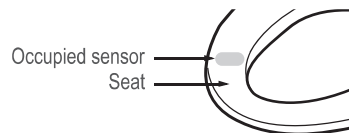

Connecting the water hose

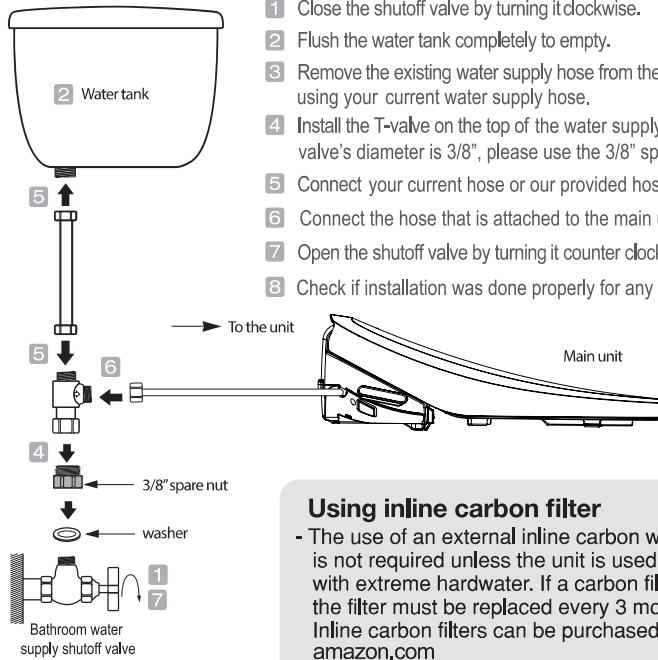

- 1 Close the shutoff valve by turning it clockwise.
- 2 Flush the water tank completely to empty.
- 3 Remove the existing water supply hose from the tank or you can continue using your current water supply hose.
- 4 Install the T-valve on the top of the water supply stop valve. If your water supply valve's diameter is 3/8", please use the 3/8" spare nut and washer.
- 5 Connect your current hose or our provided hose from the water tank to the t-valve.
- 6 Connect the hose that is attached to the main unit to the t-valve.
- 7 Open the shutoff valve by turning it counter clockwise.
- 8 Check if installation was done properly for any drips or leaks.

Using inline carbon filter

- The use of an external inline carbon water filter is not required unless the unit is used in an area with extreme hardwater. If a carbon filter is used, the filter must be replaced every 3 months. Inline carbon filters can be purchased from [amazon.com](https://www.amazon.com)

※ Shutoff valve sizes may vary. If supplied parts do not fit, please call

If a filter is used, it must be replaced every 3 months.

This product is designed and intended to exclusively use with HuliifeBidet water filters. The purchase or use of any other water filters is not the responsibility of HuliifeBidet. As such, any use of non HuliifeBidet water filters is prohibited and will void the warranty for those HuliifeBidet products. HuliifeBidet will not be responsible for any resulting damages nor claims related to the misuse or distribution of non HuliifeBidet water filters. HuliifeBidet is owned by Mungsube Enterprise Inc.

Trial operation

Checking all functions

Cover the toilet bowl using the sheet of plastic wrap on the unit to prevent the washing water from being sprayed out of the toilet.

Then check for all functions described in this manual.

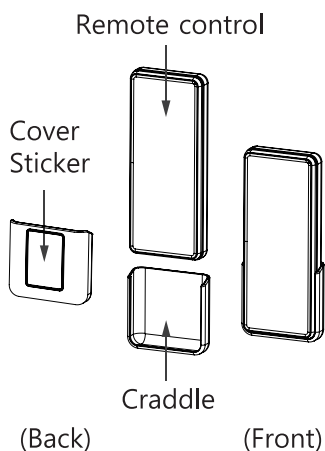

Remote control Installation

- Please decide on the location of the wall to attach the remote control cradle. (Where it is easy to reach when sitting on the toilet)
- Please wipe the dust, foreign substances from the wall and remove the cover sticker to attach the cradle.
- After confirming that the cradle is attached securely, mount the remote control.

Replacement of Battery

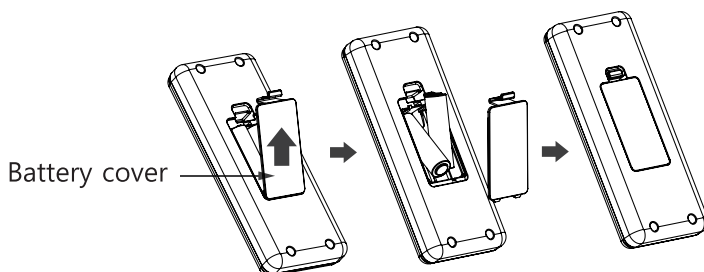

- If the LED brightness of the remote control is significantly weak or the bidet does not work when you touch the function, please replace the batteries.
- 2 AA batteries are required, and please be aware of +/- direction indicated must be correctly aligned.

How to replace the battery (See picture)

1. Pull the battery cover to open it
2. Remove the old batteries and insert new one
(Be aware of direction)
3. Close the battery cover.
4. Press the button to check whether the LED lamp is lights up.
5. Check the remote by operating bidet functions.

7. How to use

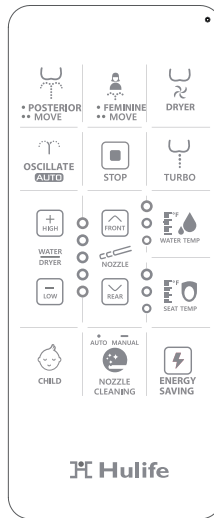

Stop

- Press this button to stop current operation.
- When a user stands up, all operation will stop automatically.



Feminine

- Press this button for feminine wash. The function will stop automatically.
- Press 'Feminine' button again to active nozzle back and forth.



Dryer

- Press this button Warm air will come out for 3 minutes.
- Dryer temperature can be adjusted by pressing LOW or HIGH button to 5 levels.



Auto

- Press this button, Oscillation cleansing(1 min)-Dry(3 min) Stop will operate automatically.



Nozzle Position

- Press this button during the operation of Cleansing, Bidet, Massage, Kids, Auto function, the nozzle position can be adjusted 5 levels.
- Nozzle position will remain.



Nozzle Cleaning

- Auto: Press the button shortly to activate nozzle cleaning automatically.
 - Manual: Press the button for 3 seconds to activate manual nozzle cleaning for 2 min. You may use brush to clean and press 'STOP' button to deactivate the manual function and nozzle will return with automatic cleaning.
- * Seat Sensor must be off



Posterior

- Press this button to clean your posterior. The function will stop in 2 min. automatically.
- Press 'Posterior' button again to active nozzle back and forth.



Turbo

- Press this button for turbo wash, a strong, concentrated yet smooth wash which helps stimulate bowel movement. The function will automatically stop in 2 minutes.
- Press the OSCILLATE button to activate the nozzle to move back and forth.
- This function has unlimited & on-demand heated water.



Water Pressure / Dry Temperature

- Water spray pressure can be adjusted by pressing to 5 levels.
- Dry temperature can be adjusted by pressing button to 5 levels.
- Water pressure level will remain.



Temperature Adjustment(water / seat)

- Temperature of seat and water can be adjusted by pressing button.
- There are four levels, Room temp - Low - Medium - High.



Child Auto Wash & Dry

- Press this button to change all functions to be suitable for children. It will automatically operate from cleansing (1 min) to dry(3 min) with adequate water pressure and nozzle position.
- This unit should be used under the supervision of an adult.



Energy Saving

- Press this button will activate Energy Saving function. (LED: Red -> Green)
- To deactivate, press the button again,(LED: Green -> Red)
- 'Energy Saving' mode will remain 89.6 °F at seat temperature and will return to set temperature when seat sensor is 'ON'
- You may disconnect the power plug when it is not in use for a long time.

1. How to Set the 'User mode'

- Key to enter the setting mode : Press ' Dryer ' + ' Posterior ' for 3 seconds
- Indication of entering Setting mode : Water pressure LED will blink
- Buzzer entering the setting mode : None
- After entering the User Mode setting, press the Posterior function.
- Set the water pressure & nozzle position.
- Press 'Dryer ' + ' Posterior' for 3 seconds and setting mode will be save.
- The water pressure LED will stop blinking and remain.(During the operation)

2. User Mode

- Press Posterior key for 3 seconds to activate the user mode.
- It will operate with saved setted water pressure and nozzle position
- If User adjust water pressure and nozzle position during the function activate, it will remain as user adjusted.
- Operate duration is same as Posterior function.
- If user press the user mode(for 3 seconds) while Posterior function is activate, nozzle oscillation will be activate.

8. How to clean



Do not forcefully push or pull the nozzles, or bend them. It may result in failure. Make sure to use "Stop" button on the remote control.

Nozzle self-cleaning function

- Self-cleaning function will automatically operate after cleaning function.
- Nozzle will spray water inside the unit and drain it.
- Press the 'Nozzle Cleaning' button will activate automatic self cleaning function.

Nozzle cleaner

- Pull the Nozzle clean cover to disassemble.
- Press the 'Nozzle Cleaning' button for 3 seconds for manual cleaning.
- You may use soft brush to clean the nozzle. Nozzle will return after 2 minutes within automatic cleaning.
- Assemble Nozzle clean cover after you finish cleaning.

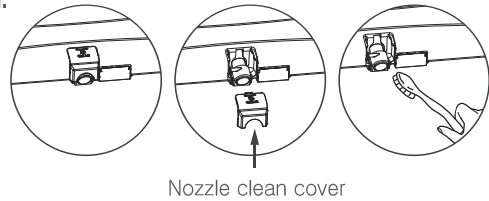

Exterior cleaning

- 1 Regularly wipe off the seat with a dry soft cloth or sponge, or wash with a damp cloth and mild detergent. (Prints on control panel may erase due to use of detergent. Please wipe off with soft mop with water.)
- 2 In order to protect plastic unit, only use neutral cleansers. (Do not use toilet cleansers, home cleansers, bleach, benzene, paint thinner, cresol)



Toilet cleansers



Thinner
Benzene



Bug killer



Sandpaper

9. Maintenance

Strainer maintenance

This appliance will not operate properly if the strainer is clogged. Be sure to clean the strainer regularly.

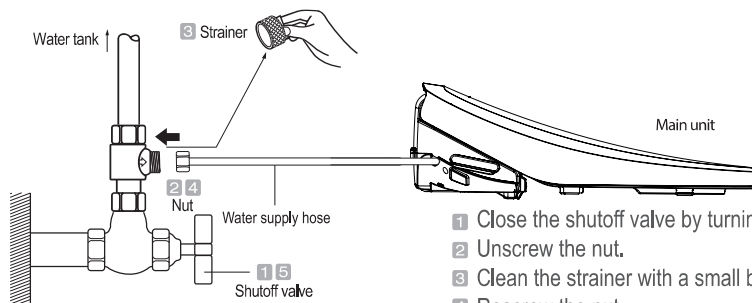

- 1 Close the shutoff valve by turning it clockwise.
- 2 Unscrew the nut.
- 3 Clean the strainer with a small bush.
- 4 Rescrew the nut.
- 5 Open the shutoff valve by turning it counter clockwise.

Preventing freezing

- 1 Make sure the power cord is properly plugged in.

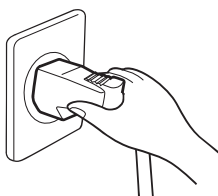

- 2 Set the water temperature to low or middle.
 - If there is no heating system in the toilet, wrap pipes with cloth or other materials.

10. Before calling for service

PROBLEM	POSSIBLE CAUSE	POSSIBLE SOLUTION
Unit completely fails to work or power on	<ol style="list-style-type: none"> 1. Power outage 2. Unit is not plugged in 3. Faulty receptacle 4. Skin sensor is not activated 	<ol style="list-style-type: none"> 1. Reset the GFI outlet 2. Plug the power cord in to a GFI outlet 3. Test another appliance in the outlet 4. Activate the skin sensor on the unit
Nozzle does not extend	<ol style="list-style-type: none"> 1. Nozzle is dirty 2. External bidet filter 3. Skin sensor is not activated 4. Seat riser is covering the skin sensor 	<ol style="list-style-type: none"> 1. Clean the nozzle 2. Remove the external bidet filter 3. Activate the skin sensor on the unit 4. The seat riser must go underneath the bidet seat
Low water pressure	<ol style="list-style-type: none"> 1. Clogged nozzle tip 2. Water pressure is set to low on the control panel 	<ol style="list-style-type: none"> 1. Clean the nozzle tip 2. Raise the water pressure on the control panel
Seat is not heating	<ol style="list-style-type: none"> 1. Unit is set on ECO mode 	<ol style="list-style-type: none"> 1. Turn off ECO mode 2. Unplug the unit for 10 sec
Stops in the middle of use	<ol style="list-style-type: none"> 1. Washing or drying exceeded cycle time 2. Skin sensor lost contact 	<ol style="list-style-type: none"> 1. Press the wash or dry mode again 2. Activate the skin sensor with full skin contact through the entire cleansing period
Water coming out from the nozzle unexpectedly	<ol style="list-style-type: none"> 1. Self-cleaning 	<ol style="list-style-type: none"> 1. The unit will self-clean the nozzle before and after each use automatically
Water leaking continuously	<ol style="list-style-type: none"> 1. Leaking from hose connection at the unit 2. Leaking from T-valve 	<ol style="list-style-type: none"> 1. Check to make sure that all rubber washers are in place and do not over tighten the connection but it should be secured 2. Check to make sure that the rubber washer is in place with the flat side pointing up

11. Specifications

Model		HLB-3000ER
Rated Voltage		120Vac, 60Hz
Max Consumption Power		1,260W
Water supply Way	Way	direct-coupled water supply system
	Rated water	0.07~0.74 (MPa)
Water Temperature Wash	Wash (ℓ /min)	0.6 ℓ /min
	Bidet (ℓ /min)	0.55 ℓ /min
	Pressure regulation	Hip wash and Down wash, common (1~5 phase)
	Water temperature adjustment	Regulation 4 stages adjust the four-stage (Off, Low, Medium, High)
	Water temperature heating	1,200W
	Backflow protection devices	For vacuum to prevent, Check valve
	Safety devices	Manually place two metal strips
Constant Temperature Toilet seat	Seat Temperature Control	Adjust the four-stage (Off, Low, Medium, High)
	Seat Heating	55W
	Safety devices	Anti-overheating temperature fuse
Drying	Dryer Temperature	Room temperature-131°F, 5 Levels
	Dryer Heat	250W Actual heating power CA(168W)
	Safety Devices	Thermal fuse
Power cord length		3'-10"
Energy Saving Mode		Yes
User water temperature		53.6°F-93.2°F (12°C~34°C)
Environment temperature		34.4°F-104°F (3°C~40°C)

Product weight	About 8.2 lbs
Size (mm)	<p>Appearance size : 19.1"W x 20.9"D x 8.1"H</p>

※ Recommended water supply pressure are 0.1~0.69MPa

※ The minimum available water supply pressure is 0.07MPa, however under 0.1MPa pressure, water spray pressure might not be adequate.

WARRANTY

Personal Hygiene Appliance Limited Warranty

- We warrant our products to be free from manufacturing defects under normal use and service for limited two (1) year from the date you purchase. Only the ORIGINAL PURCHASER you may make a claim under this limited warranty.
 - Our obligation to you under this warranty is limited to repair or replacement, at our option, of defective products or parts, provided that the products were properly installed and used in accordance with instructions. We reserve the right to make inspections in order to determine the cause of the defect. We will not charge for labor or parts in connection with warranty repairs or replacement. We are not responsible for the cost of removal, return and/or reinstallation of products.
 - This limited warranty does not apply to:
 - a) Damage or loss from a fire, earthquake, flood, storm, etc
 - b) Damage or loss resulting from any unreasonable use, abuse, negligence, or improper maintenance.
 - c) Damage or loss from improper installation, removal, repair, or modification.
 - d) Damage or loss resulting from sediment or other matters contained in your water system.
 - This warranty gives you specific legal rights.
 - For warranty or service information, please contact your dealer where you bought this appliance or us.
 - Only the original purchaser may submit a claim under this limited warranty. To activate your warranty, complete this form.
 - This limited warranty is our only warranty covering your product. Repair or replacement as provided under this warranty shall be the exclusive remedy available to you. We shall not be responsible for loss of the product or for other incidental, or consequential damage or expenses you may incur or for labor or other costs due to installation or removal, or cost or repairs by others, or for any other expense not specifically stated above. Except to the extent prohibited by applicable law, any implied warranties, including that of merchantability or fitness for use, are expressly limited to the duration of this warranty.
- ※ Warning! We are not responsible or liable for any failure of, or damage to, this plumbing product or product component caused by in-tank bowl cleaners containing chlorine(calcium hypochlorite).
- ※ Note : The use of high concentration of chlorine related products can seriously damage the fittings. This damage can cause leakage and serious property damage.

For more information, please contact your dealer or us.

Purchase Date _____ Purchased From _____
Full Name _____ Amount Paid _____ Serial # _____
Address _____ City _____ State _____ Country _____ Zip _____
Phone _____ Fax _____ E-mail _____

Mail, email or fax the warranty form to :

Mungsube Enterprise Inc.

19 Spielman Rd., Fairfield, NJ 07004

Phone : 1-888-702-0009 Fax: 862-702-3682

E-mail : cs@hulife-home.com <http://www.hulife-home.com>

Customer Service Center

Hulife.Bidet

 ADDRESS
19 Spielman Rd.,
Fairfield, NJ 07004

 TOLL-FREE NUMBER
1-888-702-0009
Monday to Friday
9:00am to 5:00pm EST

 EMAIL
cs@hulife-home.com
www.hulife-home.com

**Mungsube
Enterprise Inc.**