

## Benfield® Style Hand Bender

# How to Bend Guide 960 Series Benders

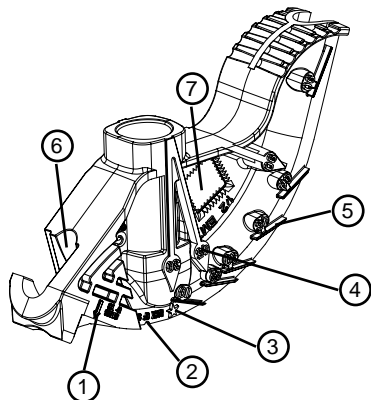

1. **ARROW**  
Indicates start of bend. Use for stubs and saddle bends.
2. **RIM NOTCH**  
Locates center of saddle bend.
3. **STAR**  
Indicates the back of a 90° bend.
4. **ANGLE ARROWS**  
Indicates the angle when bending on the floor. (sighting down the bender)
5. **DEGREE SCALES**  
Indicates the angle when bending in the air. (sighting in-line with the conduit)
6. **BEND BACK**  
Special channel designed for correcting overbends.
7. **CONDUIT VISE**  
Clamps conduit during cutting.

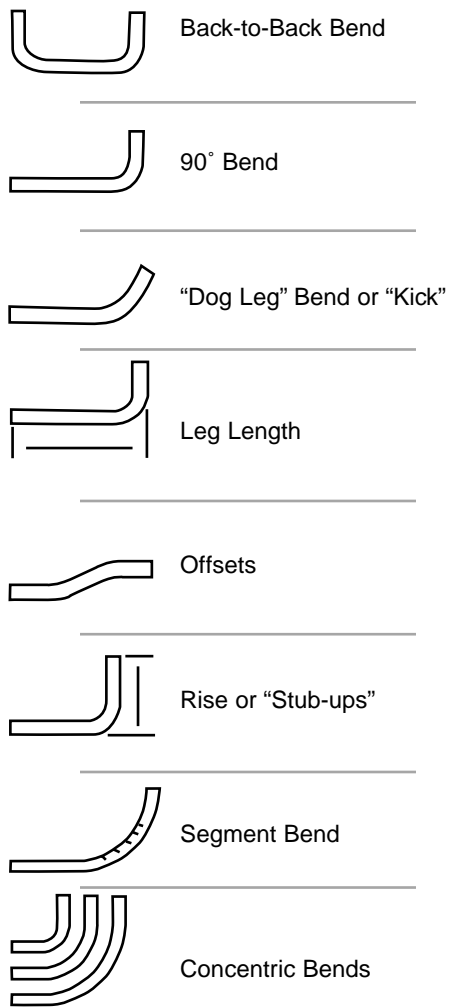

### BENDING NOTES:

Thread handles into bender head as far as they will go.

### BENDING ON THE FLOOR:

For best results keep the conduit pinned to the floor by applying constant pressure on the foot pedal throughout the entire bend.

### BENDING IN THE AIR:

Tuck the conduit under your arm and use your foot to keep the handle from sliding on the floor. Keep your hands and body close to the bender throughout the bend.

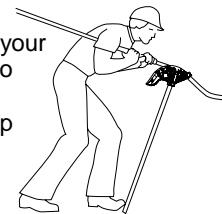

### CORRECTING OVER BENDS:

There are two options for correcting over-bends. One option uses the open end of the handle as a "cheater" bar and the second uses the hook area.

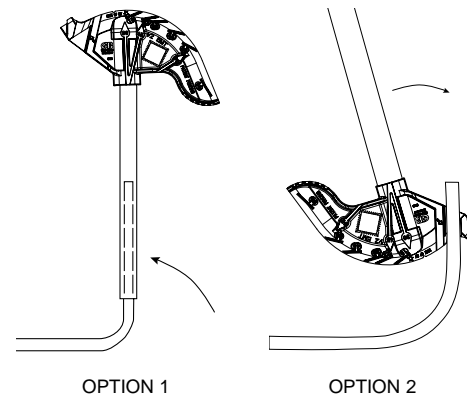

## 90° OR STUB BENDS:

### BENDING ON THE FLOOR:

1. Measure stub height (x)
2. Subtract amount shown in chart from stub height. Deduct amount is also noted on bender (example: subtract 5" for a 1/2" bender)

Conduit Size	EMT Deduct Amt.	RIGID/IMC Deduct
1/2"	5"	3 3/4"
3/4"	6"	7"
1"	8"	38 1/2"

3. Mark conduit at final deduct location.

4. Line up mark on conduit with arrow on bender. Make the bend. 

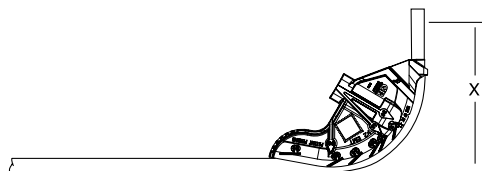
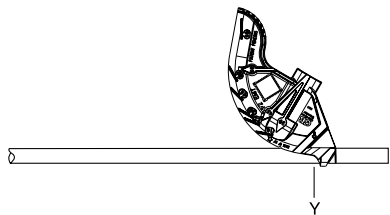
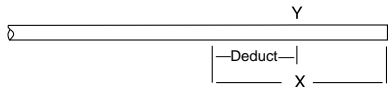

## BACK TO BACK BENDS:

1. Measure and mark distance on the conduit from a fixed point (x) to the back of the 90° bend (Y).
2. Align the mark (Y) on the conduit with the star  on the bender and make the bend.

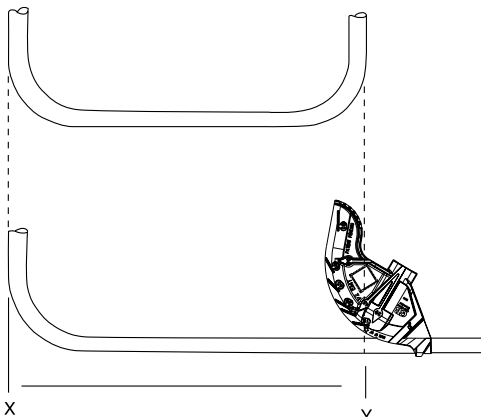

## SADDLE BENDS:

This bend is used to avoid an obstruction, such as a pipe. The most common bend is a 45° center bend and two 22 1/2° outer bends. Another method of making a saddle bend is a 60° center bend and two 30°.

1. Measure the height/diameter (D) of the object to be crossed over.
2. Measure the distance (L) to the object to be crossed over and add 3/16" to the length for each inch of the object height.
3. Mark this distance (C) on the conduit. It is the center point.
4. Make the outer bend marks (X and Y) at a distance of 2 1/2" x the object size. Mark each from the center mark.
5. Align the center mark (C) with the "notch" on the bender and make a 45° bend.
6. Align the outer marks (X and Y) with the arrow  and make a 22 1/2° bend.

Obstruction Height	Move Center Mark Ahead Distance	Make Outside Mark From Center Mark Distance
1"	3/16"	2 1/2"
2"	3/8"	5"
3"	9/16"	7 1/2"
4"	3/4"	10"
5"	15/16"	12 1/2"
6"	1 1/8"	15"

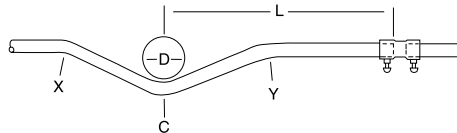

## OFFSET BENDS:

Offset bends are most commonly used to feed into a panel box or to go around an obstruction. The most common offset angle is 30° due to the angle multiplier = 2.

1. Measure the height of offset (Z).
2. Measure the distance to obstruction (L) and add shrink amount (chart below) for each inch of offset. Mark the distance on the conduit (X).
3. Using the offset height (Z) times angle multiplier (chart below) subtract this amount from the 1st mark and mark this on the conduit (Y).
4. Align the marks with the arrow  and make your bends.

Angle of Bend	Constant Multiplier	Shrinkage / Inch of Offset Depth
10°	6.0"	1/16"
21 1/2°	2.6"	3/16"
30°	2.0"	1/4"
45°	1.4"	3/8"
60°	1.2"	1/2"

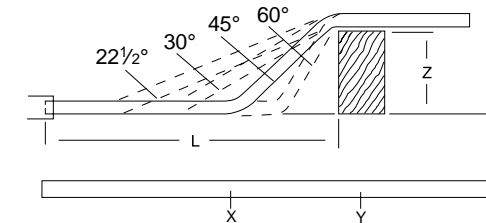

L + Shrinkage