

Assembly Instru

Caution: You must read this before









Read all instructions before assembling and using this product.

1. Select ideal location. Set out all parts on a clear and level surface. The Gazebo should be set up in the desired location to avoid damage to the lawn.
2. Team Work. We recommend 4-5 adults and it may require assistance to assemble the Gazebo. If possible, please use safety ladders.
3. Use caution. During the entire assembly process, especially when using ladders, pay attention to safety. No one other than the assembler should be in the work area.
4. Check all available parts. Before assembling your Gazebo, check the parts described in the Parts List.
5. Ensure that ALL BOLTS are fully and securely bolted in before attaching the Canopies.
6. Keep children away. Children shouldn't be allowed in the work area with parts and tools. Do not allow children to climb the Gazebo.
7. It is recommended that the curtain and mosquito netting be used in appropriate conditions.







Gazebo





Parts List

Label	Picture
A	
B	
C	
D	
E	
F	
G	
H	
I	















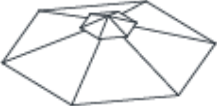

Hardware

Label	Picture
①	
②	 M6 × 50
③	 M6 × 45
④	 M6 × 15
⑤	 M6 × 25
⑥	 M6 × 30
⑦	

⑧	
⑨	
⑩	

Assembly Steps

Before
Beginning
Assembly:

- | | | |
|---|---|---|
|  | Ax6 |  |
|  | Cx6 |  |
|  | Ex6 |  |
|  | Gx6 |  |
|  | Hx1 |  |
|  ② x13 |  ③ x13 | |
|  ⑤ x7 |  ⑥ x7 | |
|  ⑧ x37 |  ⑨ x13 | |



• Read instructions, cover to cover



• Have 4-5 adults on hand for assembly



• Do not assemble on flooring or carpet



• Assemble on a clean non-marinating surface



• Save all packaging until finished

Assembly Preparation

Overview

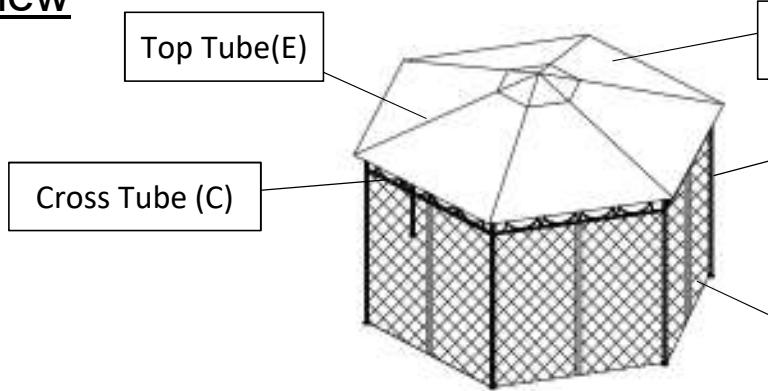

This Gazebo has multiple parts and may require up to 3 hours. This is an overview of the Gazebo parts, the above picture is to help you get a perspective. Please read through the instructions below to familiarize yourself with the steps before assembly.

Step 1

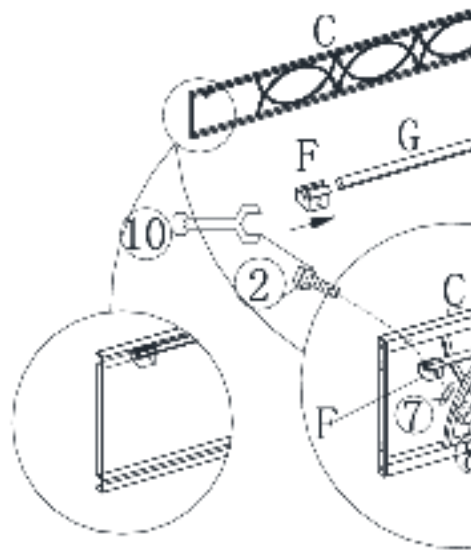

- 1.1)** Insert Connectors(F) onto both ends of Rails(G) as show
1.2) Attach Rails(G) to Cross Tubes(C) using Bolts(②), Wash Connectors(F), tightening with Spanners(⑩).
Tighten the Bolts fully in a sequential manner.

Step 2

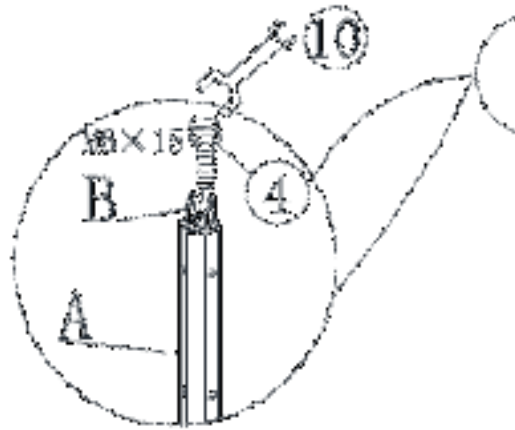

- Attach Steel Connectors(B) to Leg Tubes(A) using Bolts(④).
Tighten the Bolts fully in a sequential manner.

Step 3

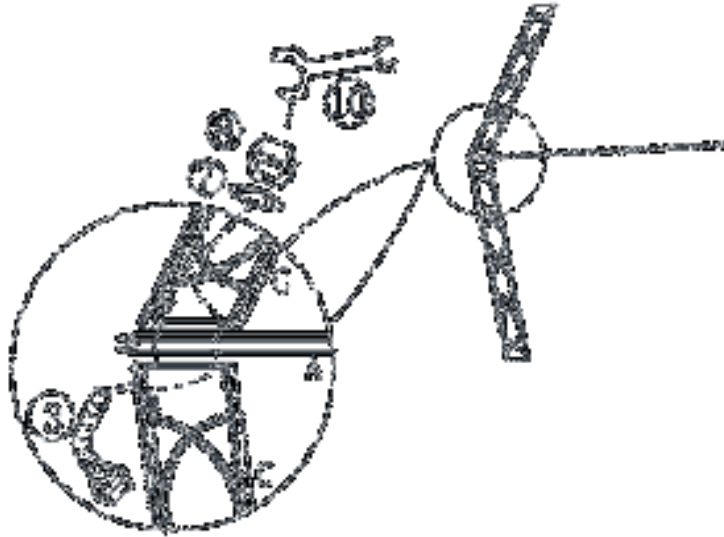

Attach Leg Tube(A) between Cross Tubes(C) using Bolts(3),
Spanners(10).
Tighten the Bolts fully in a sequential manner.

Step 4

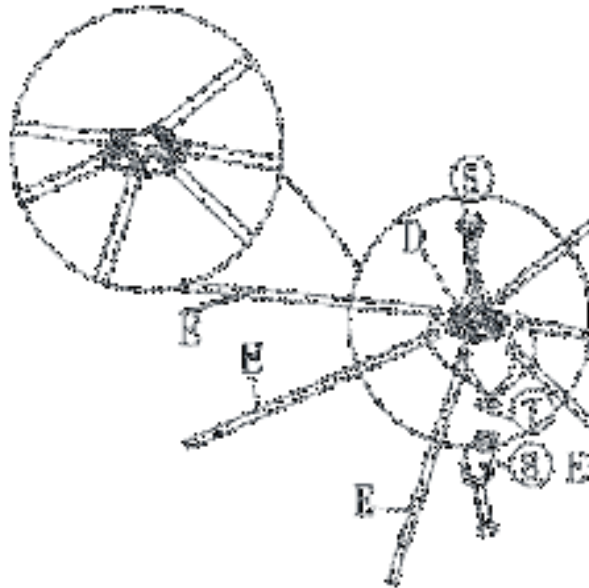

Attach Top Tubes(E) to Top Connector(D) using Bolts(5), W
Spanners(10).
Tighten the Bolts fully in a sequential manner.

Step 5

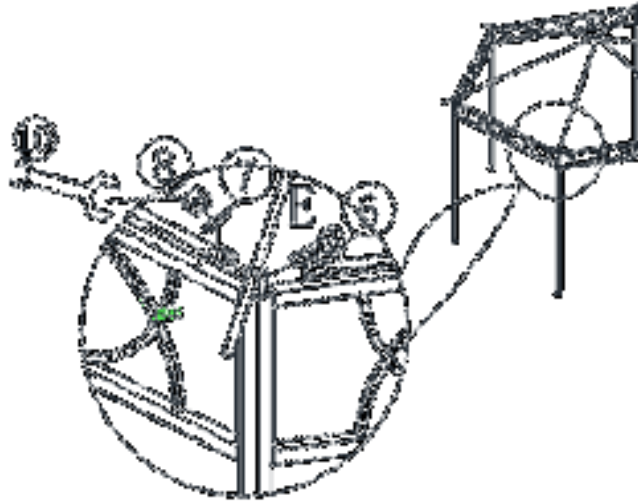

Attach Top Tubes(E) to Leg Tubes(A) using Bolts(⑥), Washers(⑩).

Tighten the Bolts fully in a sequential manner.

Note: Please use a ladder, if you can't reach it.

Step 6

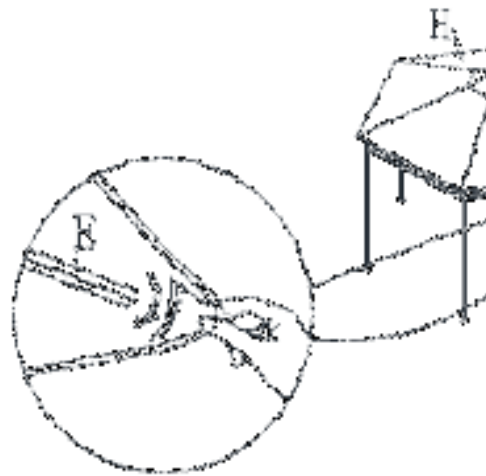

Place the Cover(H) onto the Top Tubes(E) as pictured.

Note: Please use a ladder, if you can't reach it.

Step 7

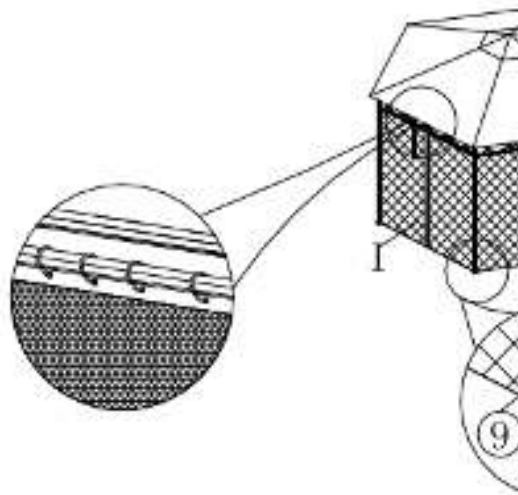

7.1) Put the Hooks(①) onto the Rails(G).

7.2) Install the Mosquito Netting(I) onto the Hooks(①).

Affix the Gazebo to the ground by inserting the Stake(⑨) through the Gazebo.
Your Gazebo is ready for use.



















This Gazebo can only be used on a flat, level surface.

Cautions:

1. Check stability and then tighten the Bolts.
2. DO NOT tighten any Bolts fully and then towards the next corner in a similar manner, gradually tighten each Bolt until all Bolts are evenly tightened. ensure maximum evenness once all Bolts are fully tightened.
3. Inspect it and make sure all parts are adequately connected.
4. This Gazebo can only be used on a flat, level surface.

Warning!! If the Gazebo is not Stable, it could lead to danger and cause injury to any occupants.

Care & Maintenance

-   Do not put hot items directly on furniture surface.
 -   Do not clean furniture with harsh cleansers or polish.
 -   To obtain the longest lifespan of your outdoor products, minimizing exposure to sunlight is recommended.
 -   Children should not climb or jump on the furniture.
 -   Do not write on furniture without a padded barrier to protect the surface.
 -   To obtain the longest lifespan of your outdoor products, avoid extended exposure to rain, snow, and direct sunshine. Whenever possible, store product and/or place under patio or awnings.
 -   Not for commercial use. For residential use only.
 -   Stains may be removed with mild soap solution and damp cloth.
-
-   Dust and pick-up spills using a clean, non-colored, lint-free cloth.

Questions & Answers about Proposition 65

• What is Proposition 65?

Proposition 65 requires businesses to provide warnings to Californians that cause cancer, birth defects or other reproductive harm. These chemicals are found in many products that Californians purchase, in their homes or workplaces, or that are released into the environment. This information must be provided, Proposition 65 enables Californians to make informed decisions about their exposures to these chemicals.

Proposition 65 also prohibits California businesses from knowingly discharging certain chemicals into sources of drinking water.

Proposition 65 requires California to publish a list of chemicals known to cause cancer or reproductive harm. This list, which must be updated at least once a year, currently contains over 900 chemicals since it was first published in 1987.

• What types of chemicals are on the Proposition 65 list?

The list contains a wide range of naturally occurring and synthetic chemicals.

in pesticides, common household products, food, drugs, dyes, or solvents manufacturing and construction, or they may be byproducts of chemical exhaust.

- What does a warning mean?

If a warning is placed on a product label or posted or distributed at a workplace, the business issuing the warning is aware or believes that it is exposing workers to chemicals.

By law, a warning must be given for listed chemicals unless the exposure is below the risk of cancer or is significantly below levels observed to cause birth defects.

- Where can I get more information on Proposition 65?

If you have specific questions on the administration or implementation of Proposition 65, contact OEHHA's Proposition 65 program at P65.Questions@oehha.ca.gov, or

ctions

efore you proceed

ect
surface prior to assembly. Ideally,
moving it after assembly.

2 to 3 hours to fully assemble the

ly when lifting heavy or large parts
ie assistants should be allowed in

Frame, make sure that you have all

fore you proceed to attach the

ork area. Do not let them handle

removed during strong windy



Description	QTY
Leg Tube	6
Steel Connector	6
Cross Tube	6
Top Connector	1
Top Tube	6
Connector	12
Rail	6
Cover	1
Mosquito Netting	6

Description	QTY
Hook	36
Bolt (M6*50mm)	13
Bolt (M6*45mm)	13
Bolt (M6*15mm)	7
Bolt (M6*25mm)	7
Bolt (M6*30mm)	7
Washer	43

Nut (M6)	37
Stake	13
Spanner	2

Bx6

Dx1

Fx12

Ix6

① x36

 ④ x7

∅ ⑦ x43

 ⑩ x2

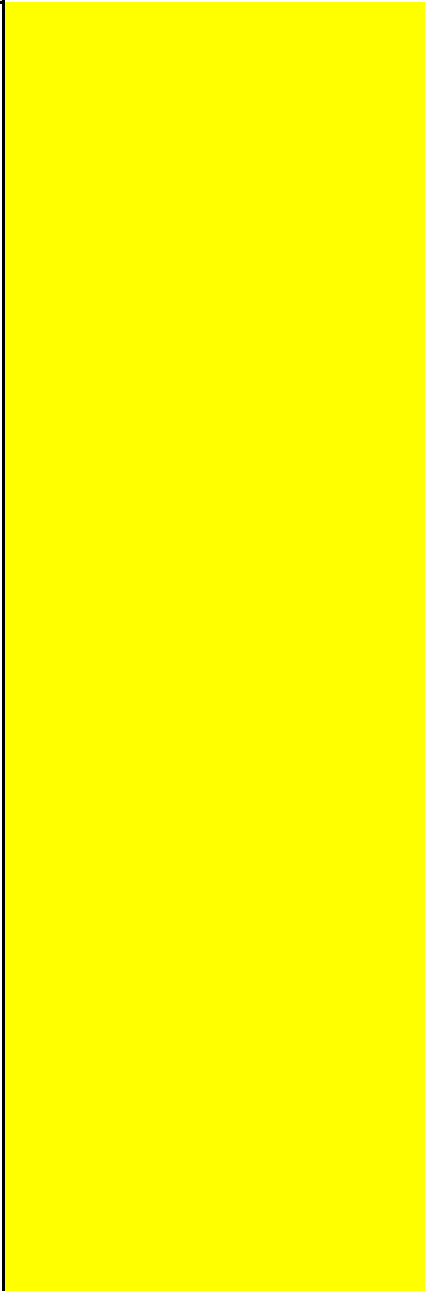

er-

mbly-

carpet-

ing surface (packing foam)-

l-



Cover (H)

Leg Tube (A)

Mosquito
Netting (I)

s to assemble. To give you an
u put the various parts into
miliarise yourself with the parts and

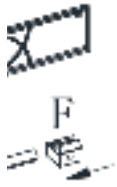

in above.
Holes(7) and Nuts(8) through



with Spanner(10).

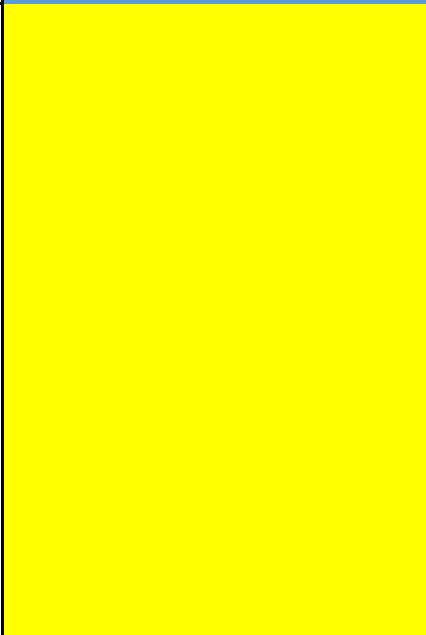
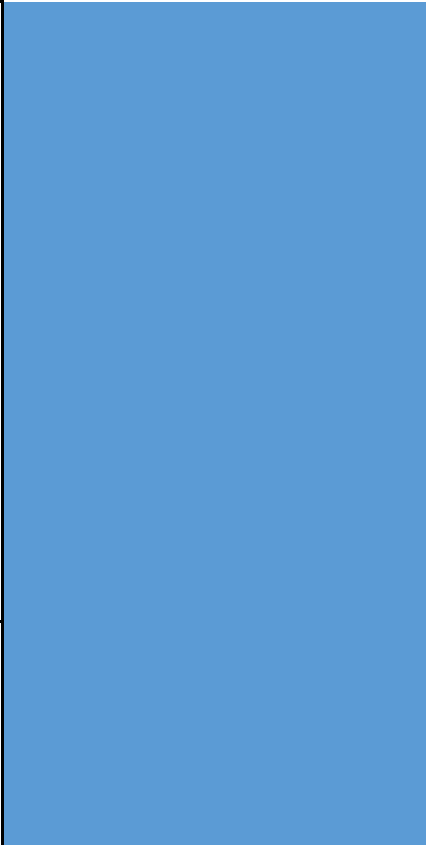

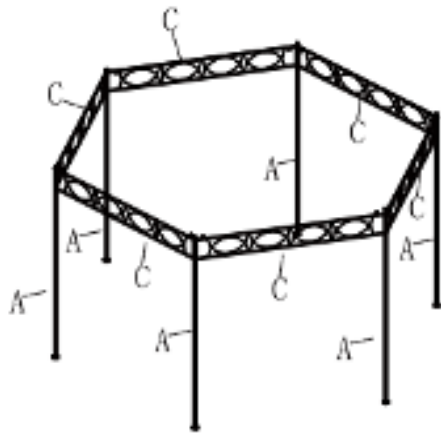

), Washers(⑦), and Nuts(⑧) with



/ashers(⑦) and Nuts(⑧) with



ers(7) and Nuts(8) with



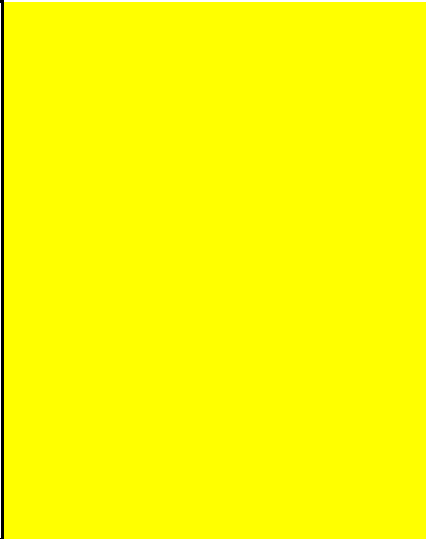

ough the Leg Tubes(A).

one. Rather, In a sequential
secured. This methodology will

ed.

nage to the product, and could

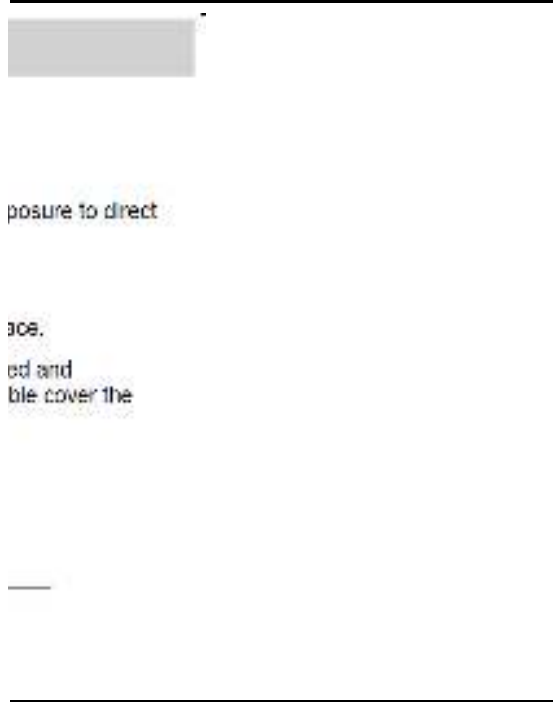

about significant exposures to chemicals
chemicals can be in the products that
end into the environment. By requiring that
make informed decisions about their

carrying significant amounts of listed

that can cause cancer, birth defects or other
health effects, has grown to include approximately

chemicals that include additives or ingredients

nts. Listed chemicals may also be used in
il processes, such as motor vehicle

orkplace, a business, or in rental housing,
g individuals to one or more listed

ire is low enough to pose no significant
fects or other reproductive harm.

of Proposition 65, you can contact
by phone at (916) 445-6900.



