

Wall flex cabinets come with the shelves and dividers you need to configure them your way.

Los gabinetes de pared flexibles vienen con los estantes y divisores que necesitas para configurarlos a tu manera.

KWFC1830

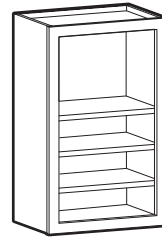
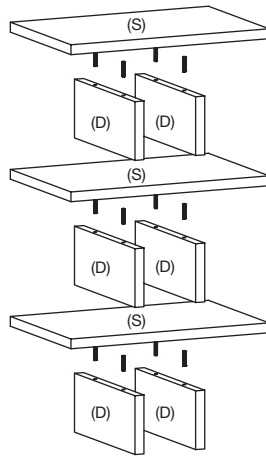
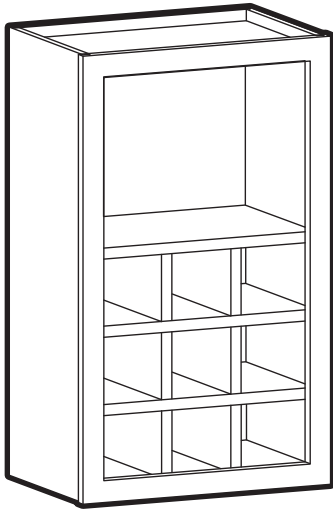

Open Shelves
Estantes abiertos

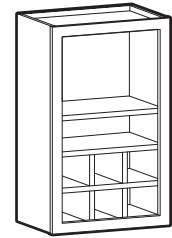

Organizer Cubes
Cubos organizadores

KWFC3018

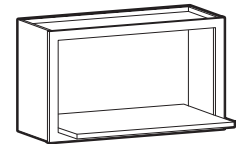
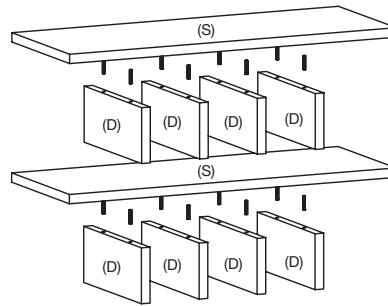
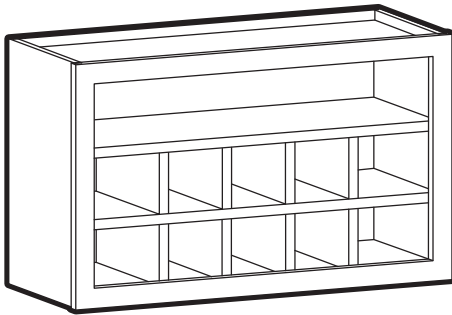

Microwave Shelf
Estante para horno de microondas

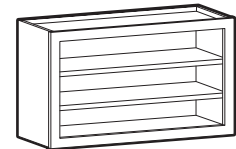

Open Shelves
Estantes abiertos

1 CABINET INSTALLATION

For mounting instructions, refer to the cabinet installation instructions on the carton or enclosed sheet.

INSTALACIÓN DEL GABINETE

Para ver las instrucciones de instalación del gabinete, consulta la caja o la hoja incluida.

2 SHELF AND DIVIDER INSTALLATION - KWFC1830, KWFC3018

A loose shelf can be installed by inserting the metal shelf pins into the side panels and setting the shelf on top. Dividers are installed by inserting dowels into the holes on the top side of the dividers (D). Select the divider location and insert dividers (D) with attached dowels into the holes of the shelf (S).

INSTALACIÓN DE ESTANTES Y DIVISORES — KWFC1830, KWFC3018

Un estante suelto se puede instalar insertando las clavijas metálicas para estante en los paneles laterales y colocando el estante en la parte superior. Los divisores se instalan insertando las clavijas en los orificios del lado superior de los divisores (D). Selecciona la ubicación del divisor e inserta los divisores (D) con las clavijas adjuntas en los orificios del estante (S).

3a MICROWAVE SHELF INSTALLATION - KWFC3018 ONLY

Install spacers (SP) to underside of the microwave shelf (MC) near the back edge with screws (S2).

INSTALACIÓN DEL ESTANTE DEL HORNO DE MICROONDAS — SÓLO KWFC3018

Instala los espaciadores (SP) al lado inferior del estante para horno de microondas (MC), cerca del borde trasero, con tornillos (S2).

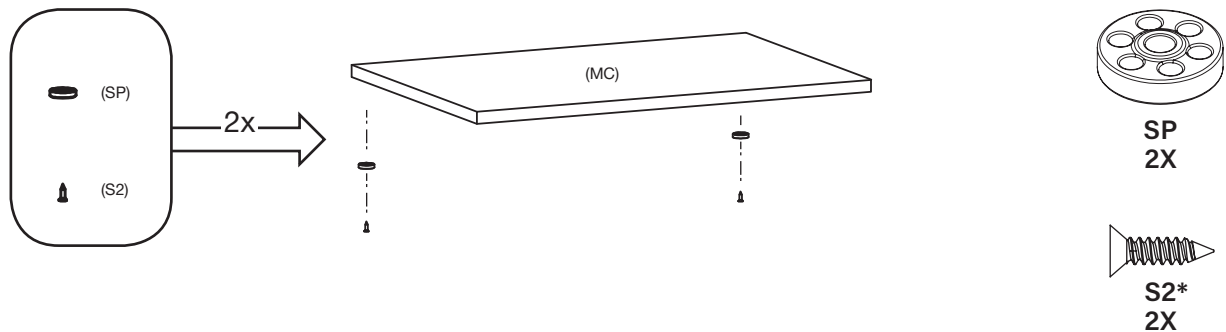

3b Secure the shelf (MC) inside the cabinet using the screws (S7) provided.

Asegura el estante (MC) dentro del gabinete usando los tornillos (S7) proporcionados.

