



OLYMPIA FAUCETS, INC.
 3325 S. Garfield Ave.
 Commerce, CA 90040
 (888) 772-7701
 www.olympiafaucets.com

INSTALLATION

Tools:



Adjustable Wrench



Plumbers Putty



Sealant Tape



Rags

Model Number: L-603X(-WD), L-609X(-WD)

Warnings and Notes:

Check with local plumbing code requirements before installation. This product should be installed by a local listed plumber. **Do not use plumbers putty on threads.**



Installation Steps:

Single Handle Lavatory Faucet

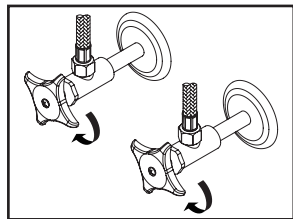

(1) Shut off the water supply. Remove old faucet. Clean mounting surface in preparation for new faucet.

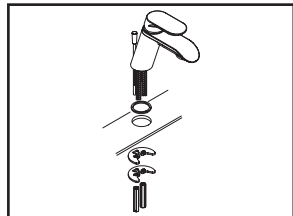

(2) **For 1-Hole Installation:** Install mounting bolts to the bottom of the faucet. Slide the gasket over the inlet supply hoses and mounting bolts. Place faucet in position on the sink. Place mounting kit over the mounting bolts under the sink. Place the rubber gasket first then the metal bracket after. Secure the mounting bolts with the mounting nuts.

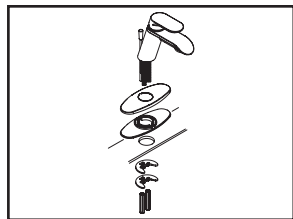

(3) **For 3-Hole Installation:** Install mounting bolts to the bottom of the faucet. Slide the gasket over the inlet supply hoses and mounting bolts. Place faucet in position on the sink. Place mounting kit over the mounting bolts under the sink. Place the rubber gasket first then the metal bracket after. Secure the mounting bolts with the mounting nuts.

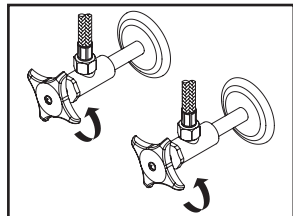

(4) Connect hot and cold inlet supply hoses to supply stops. For 1/2" connection; use 3/8" male to 1/2" female adapter for installation. Adapters are optional and not provided with faucet. Turn on both side supply stops.

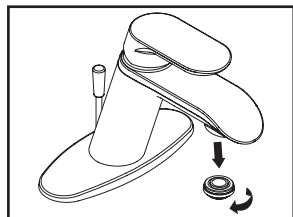

(5) Important: After installation is complete, remove the aerator. Turn on the water and allow both hot and cold water to run for at least one minute each. While water is running, check for leaks. Turn off the water and replace the aerator when finished.

Pop-Up Drain Installation:

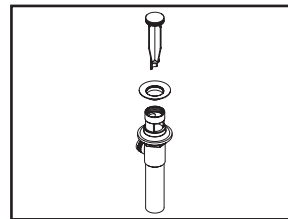

(1) Remove pop-up flange from body.

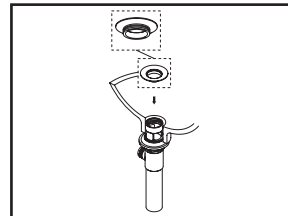

(2) Place a ring of plumbers putty on the bottom of flange.

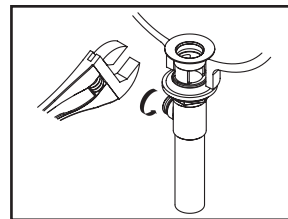

(3) Insert pop-up flange through drain hole and attach flange to the pop-up drain body. Apply Teflon tape on the threaded end of the tail piece and attach tail piece to the pop-up drain body. Ensure the pivot rod hole of the pop-up drain body faces towards the back of the sink. Tighten the locknut with the help of a wrench to secure the pop-up drain body.

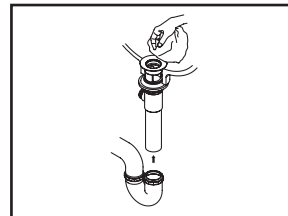

(4) Remove the excess plumbers putty. Connect the trap (check manufacturer's instructions for installation).

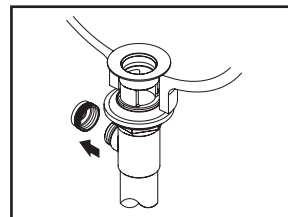

(5) Remove pivot rod nut from pop-up body, ensure the washers is in place, insert pivot rod, tighten pivot rod nut back to pop-up body.

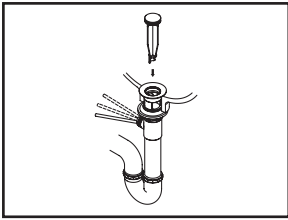

(6) Push pivot rod down, insert drain plug carefully. Test to ensure drain plug works properly.

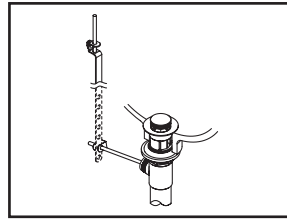

(7) Connect lift rod strap to pivot rod by using clip. Tighten the thumbscrew to connect lift rod strap to pop-up lift rod.

Exploded Drawing (L-603X(-WD)):

* Note: Please specify finish/color when ordering.

	ITEM #	DESCRIPTION
I	OP-430042	Gasket
J	OP-530005	Mounting Kit
K	OP-630005*	50/50 Pop-Up Drain Assembly (For L-6030(-WD))
L	OP-630006*	Brass Pop-Up Drain Assembly (For L-6032(-WD))
M	OP-630007*	Touch Down Drain (For L-6033)
1	OP-420047	3/32" Allen Screw
2	X-4900044*	Hole Cover

	ITEM #	DESCRIPTION
A	OP-130004*	Lever Handle
B	OP-430038*	Housing
C	OP-430039	Retainer Nut
D	X-3300006	Ceramic Disc Cartridge
E	OP-430040	1.2 GPM Aerator
F	OP-430023*	Hole Cover (For L-6031(-WD), L-6033)
G	OP-430041	Screw
H	OP-430026*	Deck Plate (For L-6030-WD, L-6031-WD, L-6032-WD)

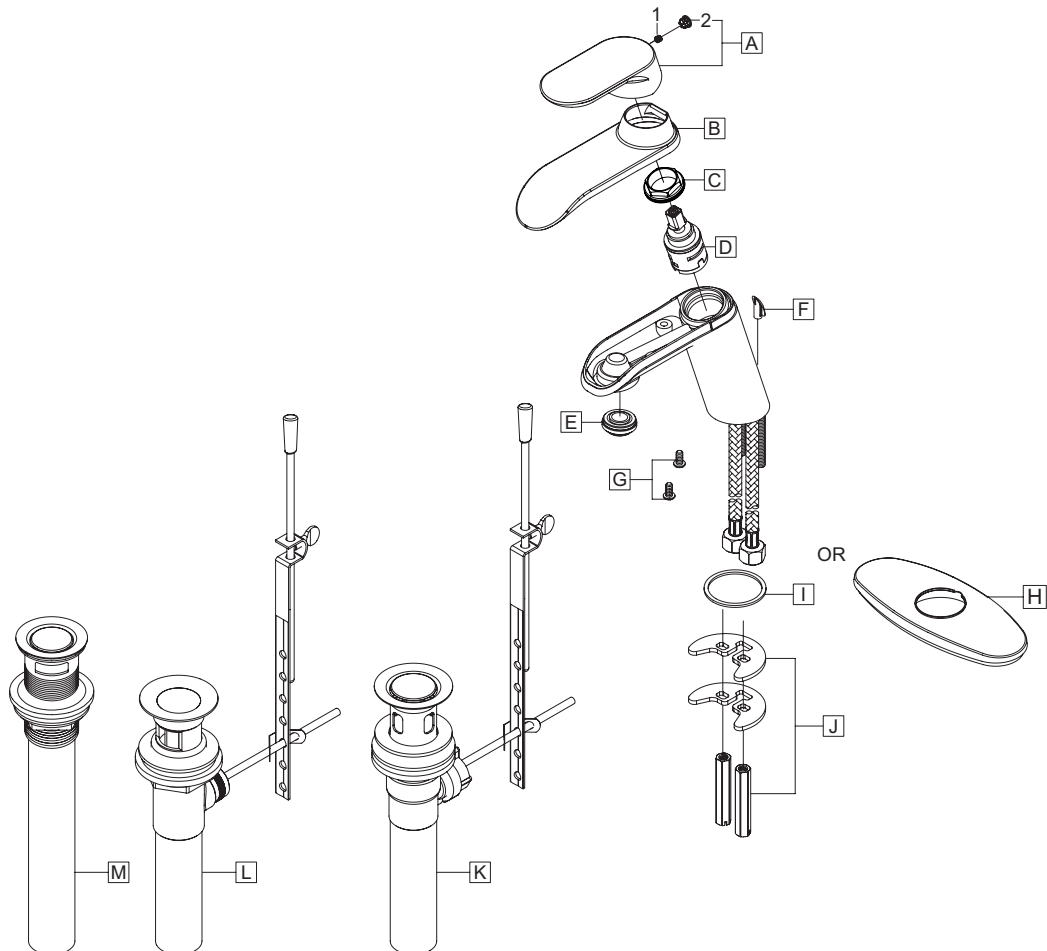

Exploded Drawing (L-609X(-WD)):

* Note: Please specify finish/color when ordering.

	ITEM #	DESCRIPTION
A	OP-130005*	Lever Handle
B	X-4300088*	Cap
C	X-4300089	Retainer Nut
D	OP-390003	Ceramic Disc Cartridge
E	OP-430045	1.2 GPM Restrictor
F	OP-490069	Aerator
G	OP-430044*	Spout Escutcheon & Gasket
H	OP-430026*	Deck Plate (For L-609X-WD)
I	OP-530005	Mounting Kit
J	OP-630013*	50/50 Pop-Up Drain Assembly (For L-6090(-WD))
K	X-6300029*	Brass Pop-Up Drain Assembly (For L-6092(-WD))
L	OP-630007*	Touch Down Drain (For L-6093)
1	OP-420047	3/32" Allen Screw
2	X-4900044*	Hole Cover

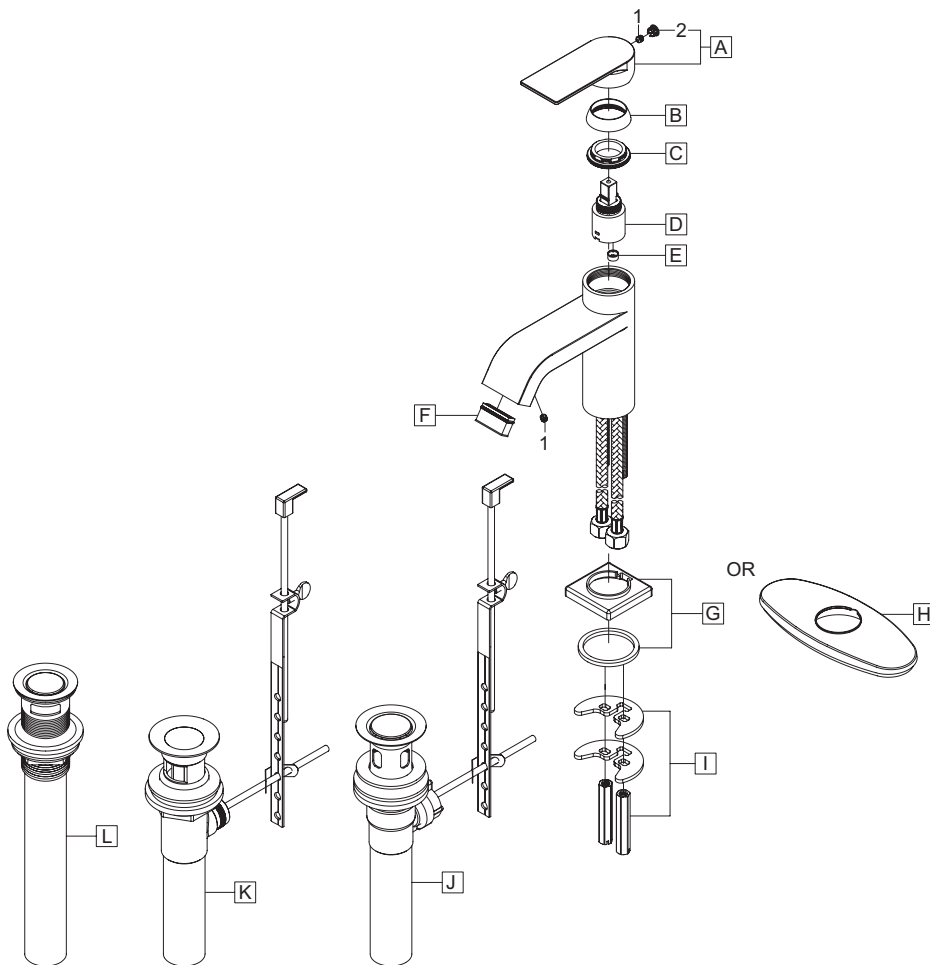

For more care information or trouble shooting inquiries about your Olympia product, Please call:
OLYMPIA FAUCETS, INC. (888) 772-7701
 Monday-Friday 8 AM to 8 PM EST (5 AM to 5 PM PST)
www.olympiafaucets.com